

Programmable AC/DC Electronic Load

User Manual for IT8600 Series

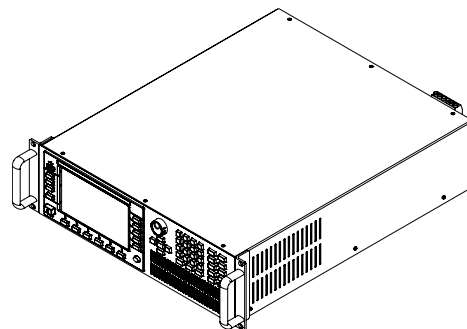

Model: IT8615/IT8615L/IT8616/IT8617/
IT8624/IT8625/IT8626/IT8627/IT8628
Version: V2.9

Notices

© Itech Electronic, Co., Ltd. 2022
No part of this manual may be reproduced in any form or by any means (including electronic storage and retrieval or translation into a foreign language) without prior permission and written consent from Itech Electronic, Co., Ltd. as governed by international copyright laws.

Manual Part Number

IT8600-402247

Revision

2nd Edition: AUG. 3, 2022
Itech Electronic, Co., Ltd.

Trademarks

Pentium is U.S. registered trademarks of Intel Corporation.

Microsoft, Visual Studio, Windows and MS Windows are registered trademarks of Microsoft Corporation in the United States and/or other countries and regions.

Warranty

The materials contained in this document are provided “as is”, and is subject to change, without prior notice, in future editions. Further, to the maximum extent permitted by applicable laws, ITECH disclaims all warranties, either express or implied, with regard to this manual and any information contained herein, including but not limited to the implied warranties of merchantability and fitness for a particular purpose. ITECH shall not be held liable for errors or for incidental or indirect damages in connection with the furnishing, use or application of this document or of any information contained herein. Should ITECH and the user enter into a separate written agreement with warranty terms covering the materials in this document that conflict with these terms, the warranty terms in the separate agreement shall prevail.

Technology Licenses

The hardware and/or software described herein are furnished under a license and may be used or copied only in accordance with the terms of such license.

Restricted Rights Legend

Restricted permissions of the U.S. government. Permissions for software and technical data which are authorized to the U.S. Government only include those for custom provision to end users ITECH provides this customary commercial license in software and technical data pursuant to FAR 12.211 (Technical Data) and 12.212 (Computer Software) and, for the Department of Defense, DFARS 252.227-7015 (Technical Data – Commercial Items) and DFARS 227.7202-3 (Rights in Commercial Computer Software or Computer Software Documentation).

Safety Notices

CAUTION

A CAUTION sign denotes a hazard. It calls attention to an operating procedure or practice that, if not correctly performed or adhered to, could result in damage to the product or loss of important data. Do not proceed beyond a CAUTION sign until the indicated conditions are fully understood and met.

WARNING

A WARNING sign denotes a hazard. It calls attention to an operating procedure or practice that, if not correctly performed or adhered to, could result in personal injury or death. Do not proceed beyond a WARNING sign until the indicated conditions are fully understood and met.



NOTE

A NOTE sign denotes important hint. It calls attention to tips or supplementary information that is essential for users to refer to.

Quality Certification and Assurance

We certify that IT8600 electronic load meets all the published specifications.

Warranty

ITECH warrants that the product will be free from defects in material and workmanship under normal use for a period of one (1) year from the date of delivery (except those described in the Limitation of Warranty below).

For warranty service or repair, the product must be returned to a service center designated by ITECH.















- The product returned to ITECH for warranty service must be shipped PREPAID. And ITECH will pay for return of the product to customer.
- If the product is returned to ITECH for warranty service from overseas, all the freights, duties and other taxes shall be on the account of customer.

Limitation of Warranty

This Warranty will be rendered invalid if the product is:

- Damage caused by circuit installed by customer or using customer own products or accessories;
- Modified or repaired by customer without authorization;
- Damage caused by circuit installed by customer or not operating our products under designated environment;
- The product model or serial number is modified, deleted, removed or illegible;
- Damaged as a result of accidents, including but not limited to lightning, moisture, fire, improper use or negligence.

Safety Symbols

	Direct current		ON (power on)
	Alternating current		OFF (power off)
	Both direct and alternating current		Power-on state
	Protective conductor terminal		Power-off state
	Earth (ground) terminal		Reference terminal
	Caution, risk of electric shock		Positive terminal
	Warning, risk of danger (refer to this manual for specific Warning or Caution information)		Negative terminal

	Frame or chassis terminal	-	-
---	---------------------------	---	---

Safety Precautions

The following safety precautions must be observed during all phases of operation of this instrument. Failure to comply with these precautions or specific warnings elsewhere in this manual will constitute a default under safety standards of design, manufacture and intended use of the instrument. ITECH assumes no liability for the customer's failure to comply with these precautions.

WARNING

- Do not use the instrument if it is damaged. Before operation, check the casing to see whether it cracks. Do not operate the instrument in the presence of inflammable gasses, vapors or dusts.
- The instrument is provided with a power cord during delivery and should be connected to a socket with a protective earth terminal, a junction box or a three-phase distribution box. Before operation, be sure that the instrument is well grounded.
- Make sure to use the power cord supplied by ITECH.
- Check all marks on the instrument before connecting the instrument to power supply.
- Use electric wires of appropriate load. All loading wires should be capable of bearing maximum short-circuit of electronic load without overheating. If there are multiple loads, each pair of the load power cord must be carry out the full rated short-circuit output current of the power securely.
- Ensure the voltage fluctuation of mains supply is less than 10% of the working voltage range in order to reduce risks of fire and electric shock.
- Do not install alternative parts on the instrument or perform any unauthorized modification.
- Do not use the instrument if the detachable cover is removed or loose.
- To prevent the possibility of accidental injuries, be sure to use the power adapter supplied by the manufacturer only.
- We do not accept responsibility for any direct or indirect financial damage or loss of profit that might occur when using the instrument.
- This instrument is used for industrial purposes, Do not apply this product to IT power supply system.
- Never use the instrument with a life-support system or any other equipment subject to safety requirements.

WARNING

- **SHOCK HAZARD Ground the Instrument.** This product is provided with a protective earth terminal. To minimize shock hazard, the instrument must be connected to the AC mains through a grounded power cable, with the ground wire firmly connected to an electrical ground (safety ground) at the power outlet or distribution box. Any interruption of the protective (grounding) conductor or disconnection of the protective earth terminal will cause a potential shock hazard that could result in injury or death.

- Before applying power, verify that all safety precautions are taken. All connections must be made with the instrument turned off, and must be performed by qualified personnel who are aware of the hazards involved. Improper actions can cause fatal injury as well as equipment damage.
- **SHOCK HAZARD, LETHAL VOLTAGES** This product can input the dangerous voltage that can cause personal injury, and the operator must always be protected from electric shock. Ensure that the input electrodes are either insulated or covered using the safety covers provided, so that no accidental contact with lethal voltages can occur.
- Never touch cables or connections immediately after turning off the instrument. Verify that there is no dangerous voltage on the electrodes or sense terminals before touching them.

CAUTION

- Failure to use the instrument as directed by the manufacturer may render its protective features void.
- Always clean the casing with a dry cloth. Do not clean the internals.
- Make sure the vent hole is always unblocked.

Environmental Conditions

The instrument is designed for indoor use and an area with low condensation. The table below shows the general environmental requirements for the instrument. The speed of fan will change intelligently by the temperature of radiator. When the temperature is up to 40°C, the fan will be on and adjust intelligently when temperature changes.



Environmental Conditions	Requirements
Operating temperature	0°C to 40°C
Operating humidity	20%-80% (non-condensation)
Storage temperature	-20°C to 70 °C
Altitude	≤2,000m
Pollution degree	Pollution degree 2
Installation category	II



NOTE

To make accurate measurements, allow the instrument to warm up for 30 min before operation.

Regulatory Markings

	The CE mark is a registered trademark of the European Community. This CE mark shows that the product complies with all the relevant European Legal Directives.
	The instrument complies with the WEEE Directive (2002/96/EC) marking requirement. This affixed product label indicates that you must not discard the electrical/electronic product in domestic household waste.



This symbol indicates the time period during which no hazardous or toxic substances are expected to leak or deteriorate during normal use. The expected service life of the product is 10 years. The product can be used safely during the 10-year Environment Friendly Use Period (EFUP). Upon expiration of the EFUP, the product must be immediately recycled.

Waste Electrical and Electronic Equipment (WEEE) Directive



2002/96/EC Waste Electrical and Electronic Equipment (WEEE) Directive

This product complies with the WEEE Directive (2002/96/EC) marking requirement. This affix product label indicates that you must not discard the electrical/electronic product in domestic household waste.

Product Category

With reference to the equipment classifications described in the Annex I of the WEEE Directive, this instrument is classified as a "Monitoring and Control Instrument" product.

To return this unwanted instrument, contact your nearest ITECH office.

Compliance Information

Complies with the essential requirements of the following applicable European Directives, and carries the CE marking accordingly:

- Electromagnetic Compatibility (EMC) Directive 2014/30/EU
- Low-Voltage Directive (Safety) 2014/35/EU

Conforms with the following product standards:

EMC Standard

IEC 61326-1:2012/ EN 61326-1:2013 ¹²³

Reference Standards

CISPR 11:2009+A1:2010/ EN 55011:2009+A1:2010 (Group 1, Class A)

IEC 61000-4-2:2008/ EN 61000-4-2:2009

IEC 61000-4-3:2006+A1:2007+A2:2010/ EN 61000-4-3:2006+A1:2008+A2:2010

IEC 61000-4-4:2004+A1:2010/ EN 61000-4-4:2004+A1:2010

IEC 61000-4-5:2005/ EN 61000-4-5:2006

IEC 61000-4-6:2008/ EN 61000-4-6:2009

IEC 61000-4-11:2004/ EN 61000-4-11:2004

1. The product is intended for use in non-residential/non-domestic environments. Use of the product in residential/domestic environments may cause electromagnetic interference.
2. Connection of the instrument to a test object may produce radiations beyond the specified limit.
3. Use high-performance shielded interface cable to ensure conformity with the EMC standards listed above.

Safety Standard

IEC 61010-1:2010/ EN 61010-1:2010

Contents

Quality Certification and Assurance.....	i
Warranty.....	i
Limitation of Warranty.....	i
Safety Symbols.....	i
Safety Precautions.....	ii
Environmental Conditions.....	iii
Regulatory Markings.....	iii
Waste Electrical and Electronic Equipment (WEEE) Directive.....	iv
Compliance Information.....	v
Chapter1 Inspection and Installation.....	1
1.1 Verifying the Shipment.....	1
1.2 Instrument Size Introduction.....	1
1.3 Connecting the Power Cord.....	9
1.4 Connecting Test Lines.....	11
Chapter2 Quick Start.....	13
2.1 Brief Introduction.....	13
2.2 Front Panel Introduction.....	14
2.3 Key Introduction.....	14
2.4 Introduction to Information on the Interface.....	16
2.5 Introduction to Interface Symbols.....	17
2.6 Rear Panel Introduction.....	17
2.7 Power-on Self-test.....	21
Chapter3 Basic Operations.....	25
3.1 Input On/Off Control.....	25
3.2 Key Lock Function.....	25
3.3 Menu Configuration Function.....	25
3.4 Configuration Save/Recall.....	27
3.5 Screen Capture Function.....	28
3.6 Local/Remote Switching Function.....	28
3.7 Load Switching.....	28
3.8 Operating Mode.....	28
3.9 Data Recording Function.....	29
3.10 Online Load Setting.....	29
3.11 Timing Mode.....	29
3.12 Protection Function.....	30
3.13 Remote Measurement Function.....	33
3.14 External On/Off Control.....	34
3.15 External Analog Quantity Control (Only for IT8615 /IT8615L).....	34
3.16 Voltage/Current Monitoring (I/V Monitor).....	34
3.17 Parallel Function.....	34
3.18 Three-phase Function.....	40
3.19 Three-phase Parallel Function.....	45
3.20 Three-phase setup.....	47
Chapter4 Load Functions.....	49
4.1 Load Function Introduction.....	49
4.2 AC Load Function.....	49
4.2.1 CF and PF Setting.....	49
4.2.2 Constant Current Mode (CC).....	51
4.2.3 Constant Resistance Mode (CR).....	55
4.2.4 Constant Power Mode (CP).....	56
4.3 DC Load Function.....	59
4.3.1 Constant Current Mode (CC).....	59
4.3.2 Constant Resistance Mode (CR).....	60
4.3.3 Constant Voltage Mode (CV) (Only for IT8615/IT8615L).....	60
4.3.4 Constant Power Mode (CP).....	60
4.3.5 Short Circuit Simulation Function.....	60
Chapter5 Measurement Functions.....	62

5.1 Interface Introduction	62
5.2 Parameter Measurement	62
5.2.1 AC Mode	63
5.2.2 DC Mode	65
Chapter6 Waveform Display Function.....	68
6.1 Interface Introduction	68
6.2 Adjustment of Measurement Parameters	71
6.3 Setting of Trigger Configuration	71
Chapter7 Harmonic Measurement Function	73
7.1 Overview	73
7.2 Setting of Harmonic Measurement Configuration	75
Chapter8 Routine Maintenance	77
8.1 Error Information Reference	77
8.2 Routine Maintenance	78
8.3 Contact ITECH Engineer	79
8.4 Return for Repair	80
Chapter9 Communication Interfaces	82
9.1 USB Interface	82
9.2 GPIB Interface	82
9.3 LAN Interface	82
Chapter10 Technical Specifications	83
10.1 Main Technical Specifications	83
10.2 Supplemental characteristics	97
Appendix	98
Specifications of Red and Black Test Lines	98

Chapter1 Inspection and Installation

1.1 Verifying the Shipment

Unpack the box and check the contents before operating the instrument. If wrong items have been delivered, if items are missing, or if there is a defect with the appearance of the items, contact the dealer from which you purchased the instrument immediately. The package contents include:

Checklist of Package Contents

Item	Qty.	Model	Remarks
Programmable AC/DC load	x1	IT8600 series	IT8600 series including: IT8615/IT8615L/IT8616/IT8617 /IT8624/IT8625/IT8626/IT8627 /IT8628
Power cord	x1	IT-E171/IT-E172/ IT-E173/IT-E174	User may select an appropriate power cord that matches the specifications of power socket used in the area. See the Section 1.3 Connecting the Power Cord.
Test leads	-	-	This series are standard equipped with a set of red and black test line.
USB cable	x1	-	-
Ex-factory Test Report	x1	-	It is the test report of the instrument before delivery.



NOTE

Upon verification of the shipment, keep the package and relevant contents thereof in a safe place. When returning the instrument for warranty service or repair, the specified packing requirements shall be met.

1.2 Instrument Size Introduction

The instrument should be installed at well-ventilated and rational-sized space. Please select appropriate space for installation based on the electronic load size.

IT8616 and IT8617 have two sizes, including side plate structure and 15U cabinet. Besides, the 15U cabinet of IT8617 also has two types: one consists of one master and two slaves and the other consists of three masters. You can choose according to your requirement.

IT8615/IT8615L

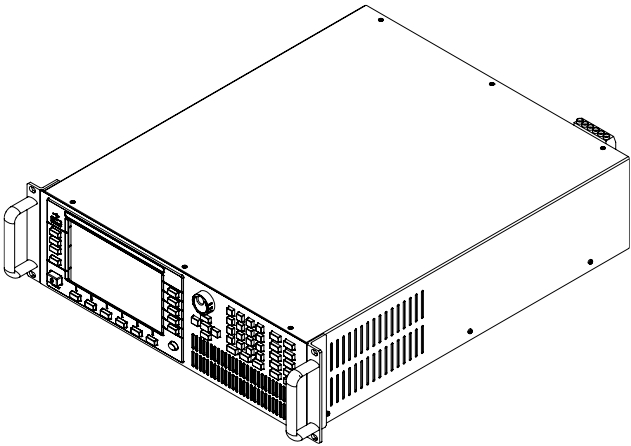

Dimension:
Width: 482.50mm
Height: 151.35mm
Depth: 600.60mm

Detailed Dimension Drawing

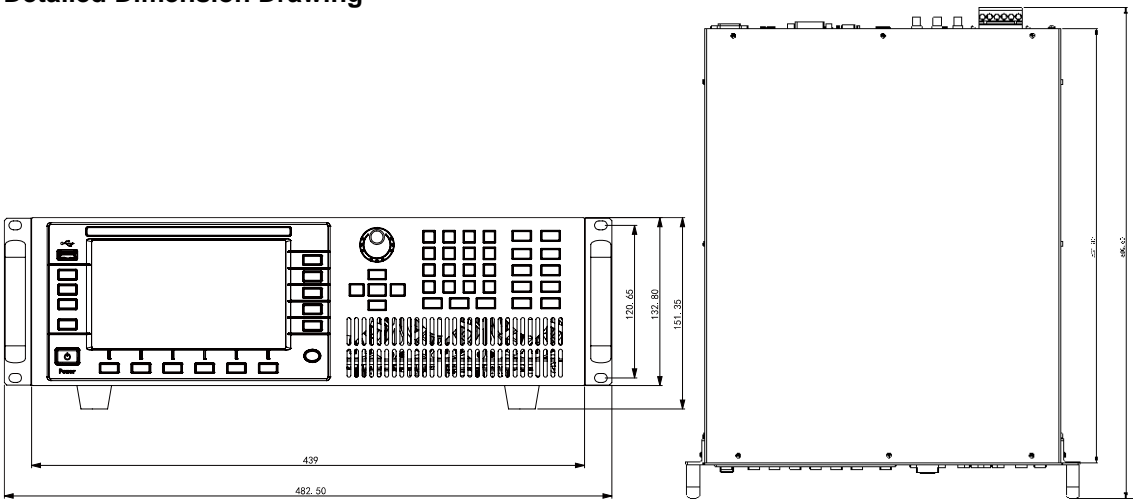

IT8616 (side plate structure)

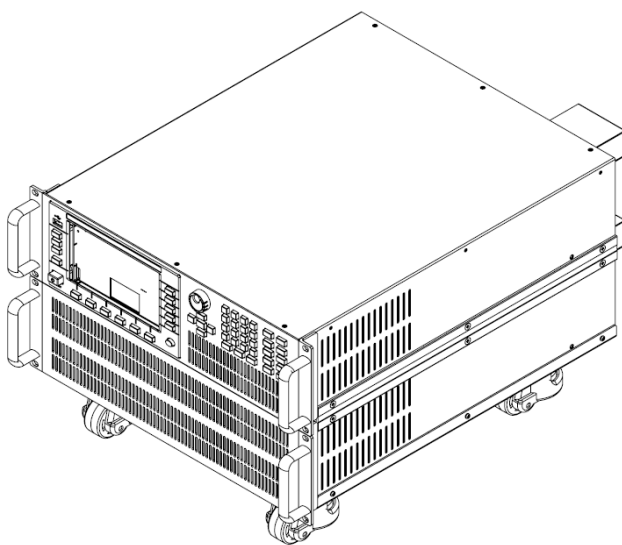

Dimension:
Width: 483.00mm
Height: 348.99mm
Depth: 641.08mm

Detailed Dimension Drawing

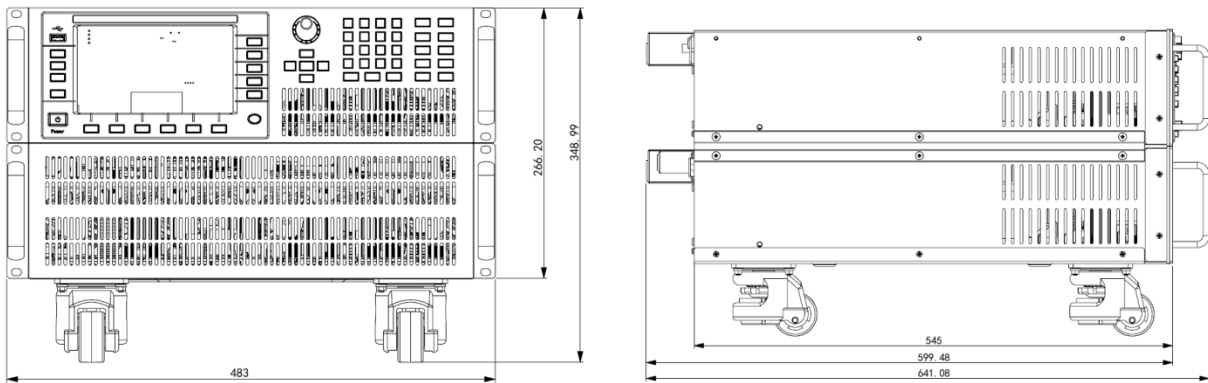

IT8616 (15U cabinet)

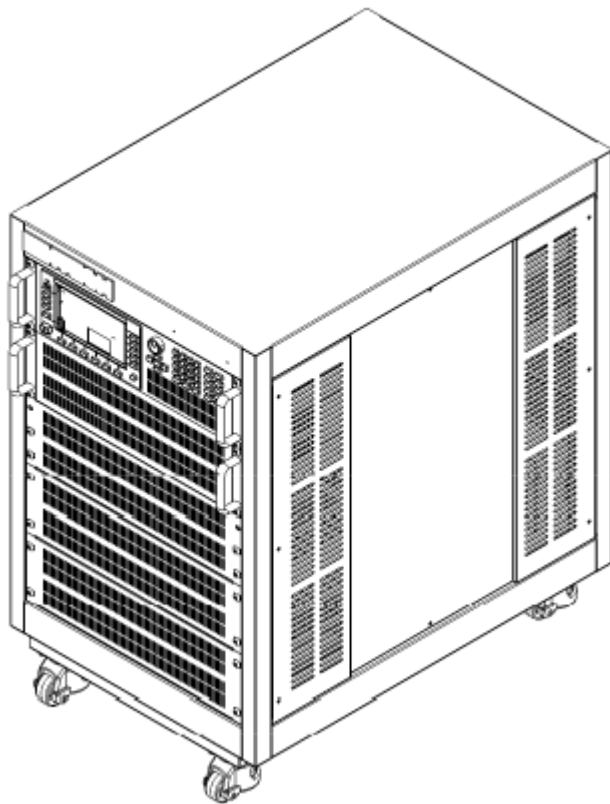

Dimension:
Width: 550.00mm
Height: 801.40mm
Depth: 839.10mm

Detailed Dimension Drawing

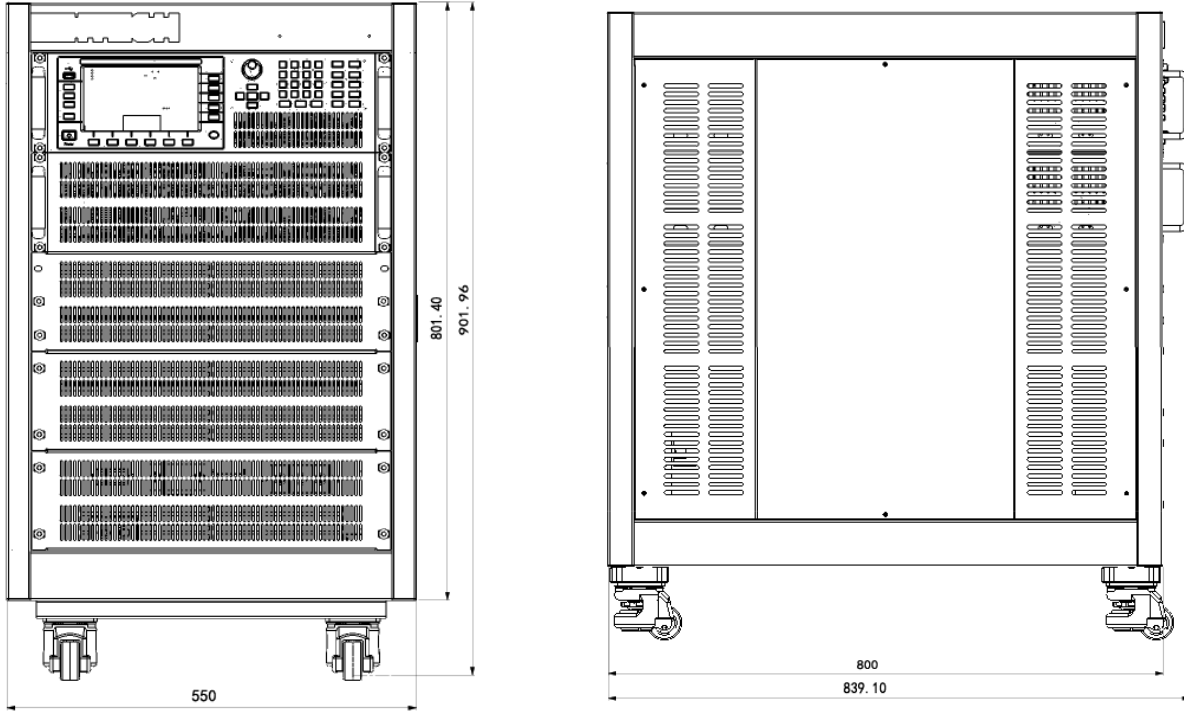

IT8617 (side plate structure)

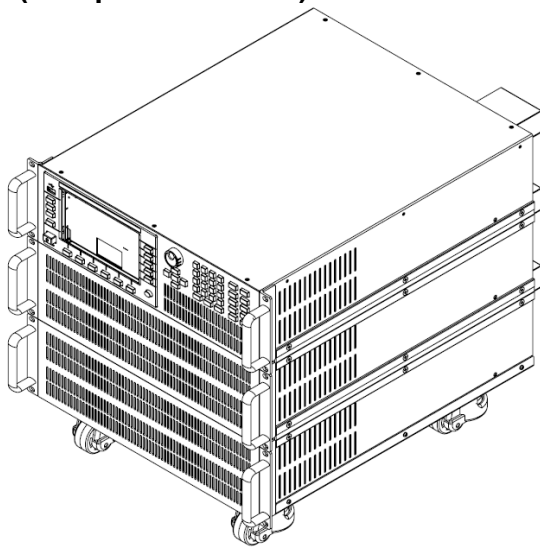

Dimension:
 Width:483.00mm
 Height:482.34mm
 Depth:641.08mm

Detailed Dimension Drawing

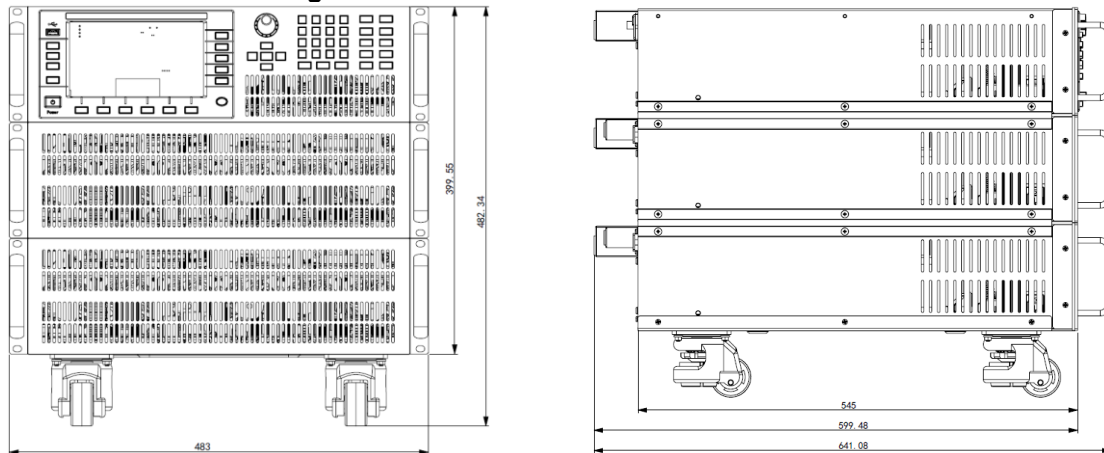

IT8617 (15U cabinet: one master and two slaves)

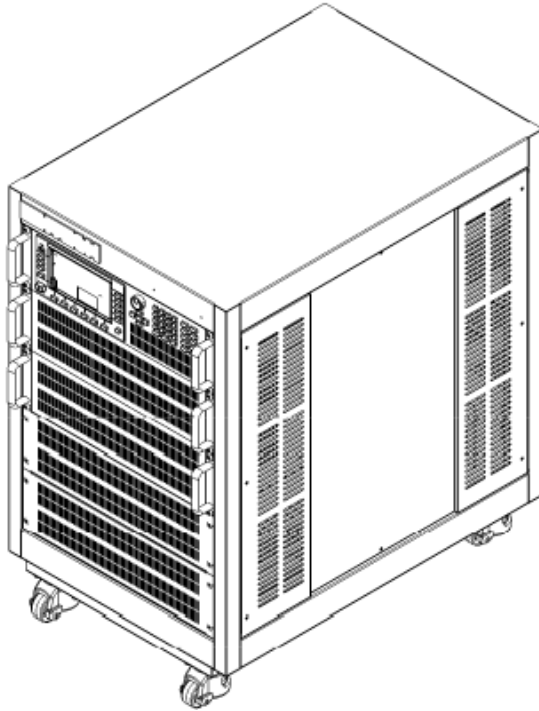

Dimension:
Width: 550.00mm
Height: 801.40mm
Depth: 839.10mm

Detailed Dimension Drawing

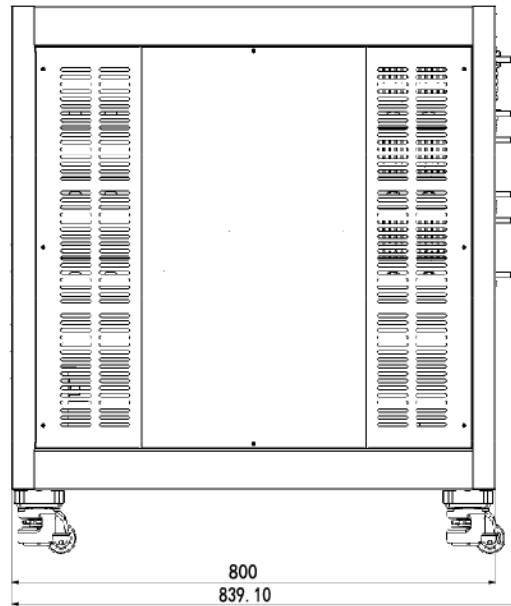
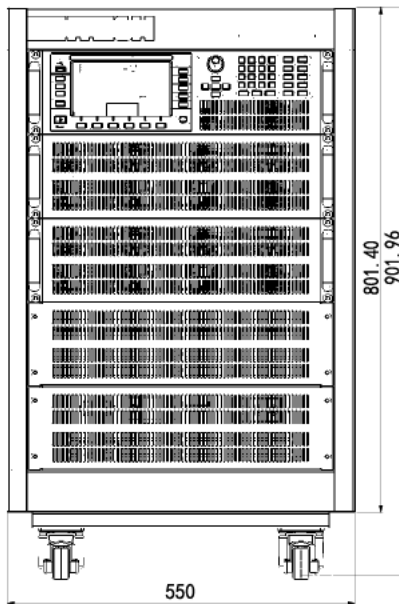

IT8617 (15U cabinet: three masters)

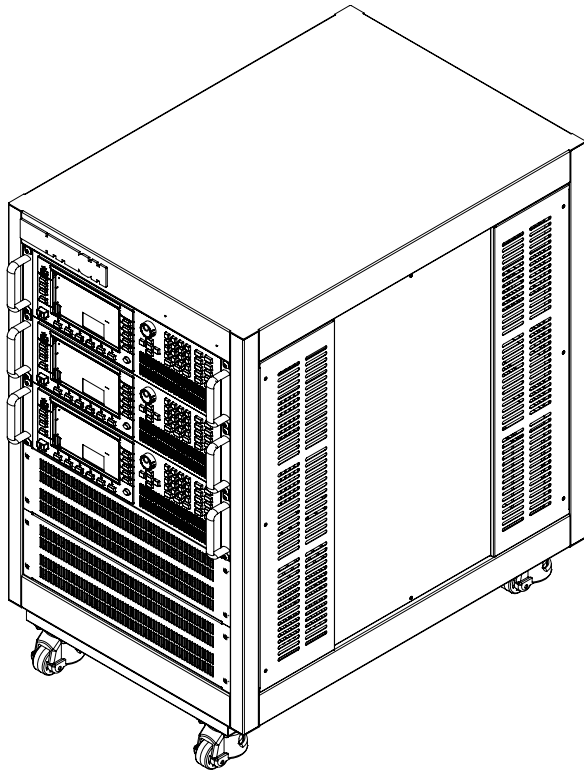

Dimension:
 Width: 550.00mm
 Height: 801.40mm
 Depth: 839.10mm

Detailed Dimension Drawing

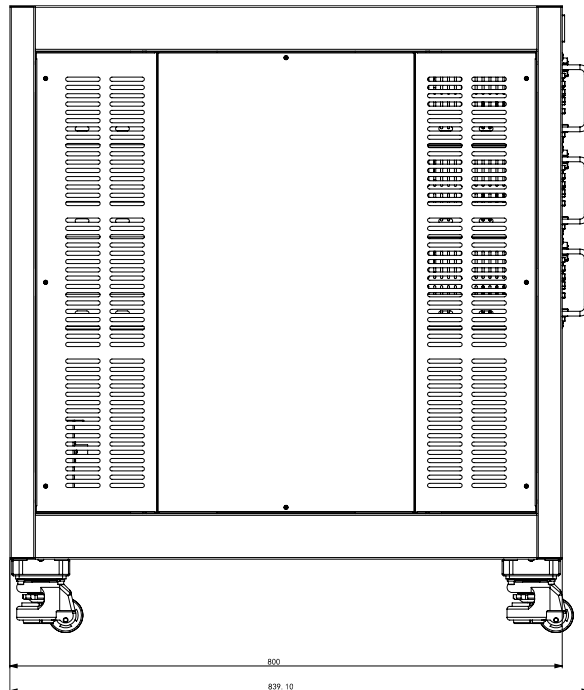
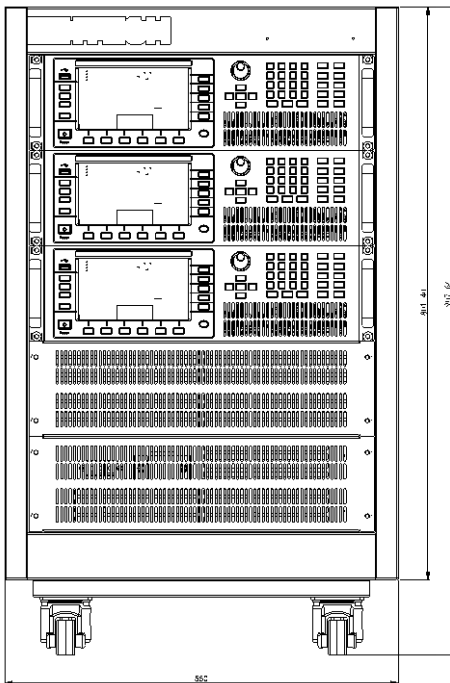

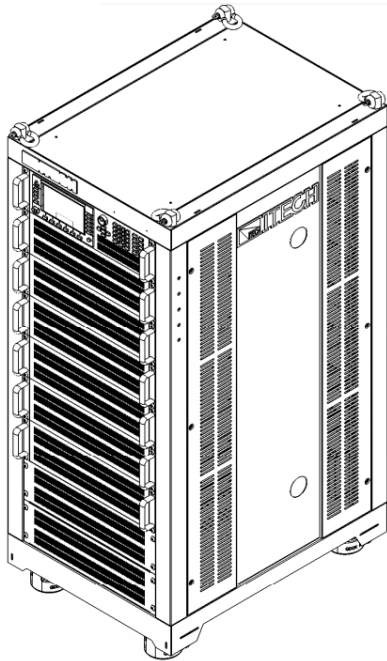

Dimension:
Width: 600.00mm
Height: 1441.51mm
Depth: 841.10mm

Detailed Dimension Drawing

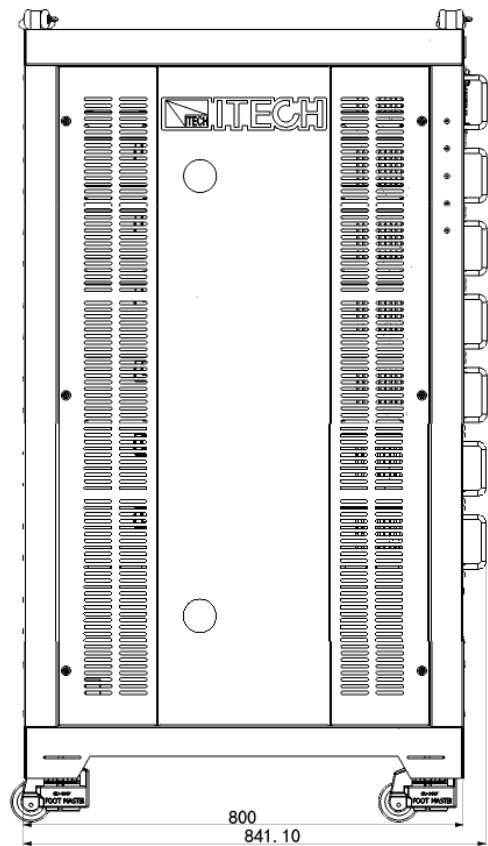
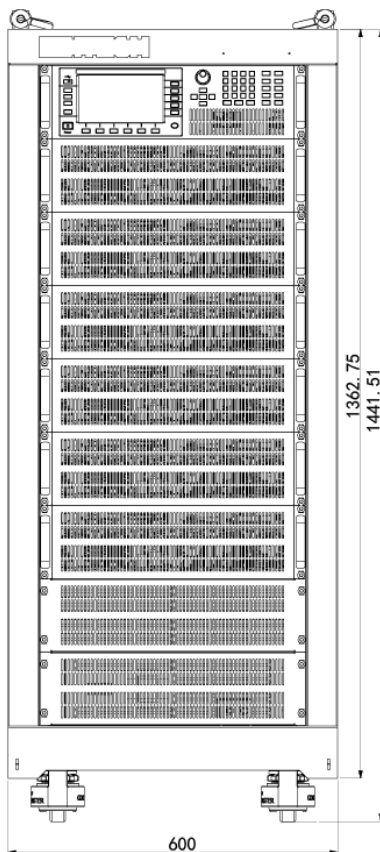

IT8627/IT8628

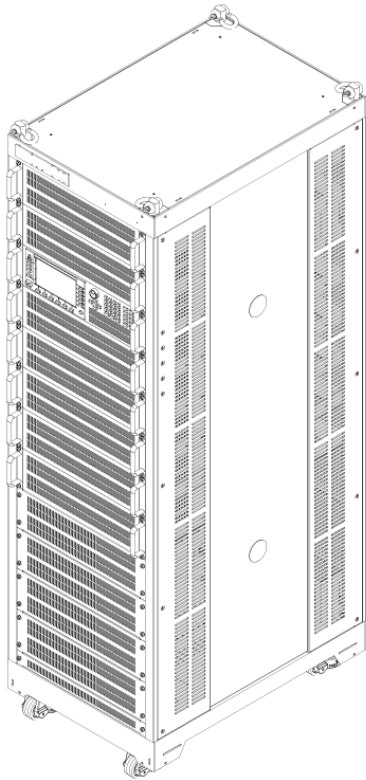

Dimension:
Width: 600.00mm
Height: 1886.06mm
Depth: 841.10mm

Detailed Dimension Drawing

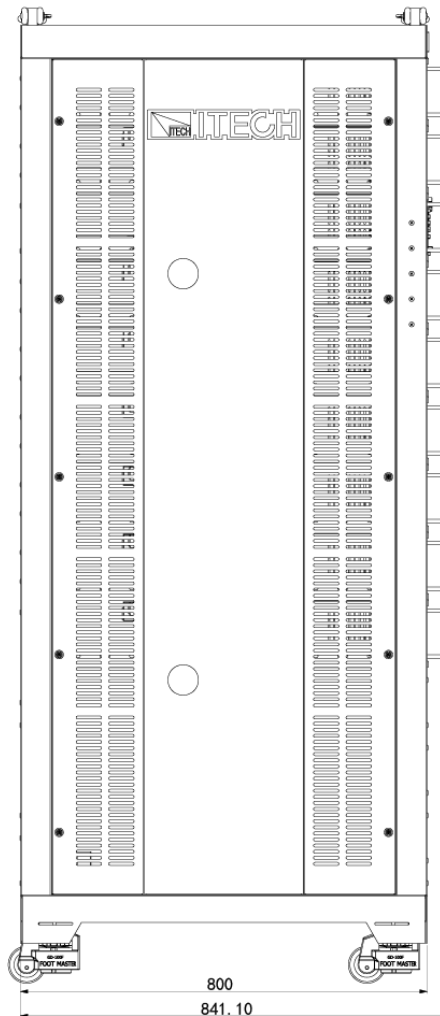
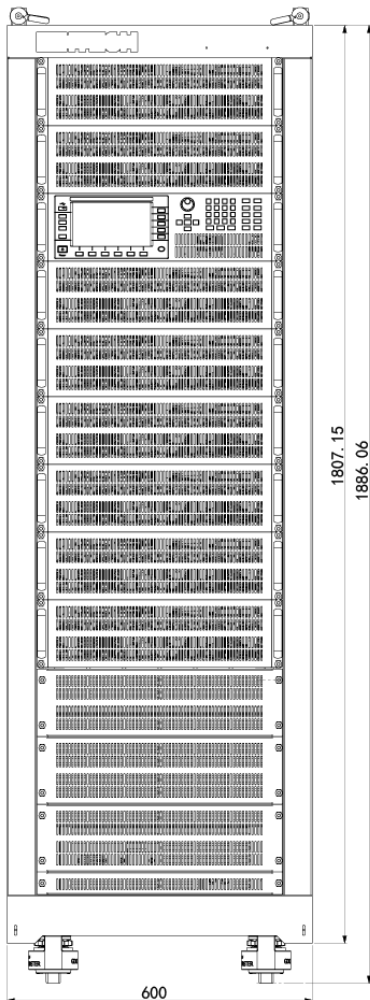

1.3 Connecting the Power Cord

Before Connecting the Power Cord

Connect power cord of standard accessories and ensure that the electronic load is under normal power supply.

WARNING

- The power cords supplied with this product is certified for safety. In case the supplied lines assembly needs to be replaced, or an extension lines must be added, be sure that it can meet the required power ratings of this product. Any misuse voids the warranty of this product.
- Before connecting power cord, be sure to switch off the instrument. Power switch is in Off position.
- To avoid fire or electric shock, Make sure to use the power cord supplied by ITECH.
- Be sure to connect the main power socket to the power outlet with protective grounding. Do not use terminal board without protective grounding.
- Do not use an extended power cord without protective grounding, otherwise the protection function will fail.

Categories of Power Cords

- We provide standard power cords for IT8615/IT8615L and IT8616/IT8617 side plate structure. Please select appropriate power cords appropriate to local voltage based on the specifications of power cords below. If purchased model fails to meet local voltage requirements, please contact distributor or factory for change.

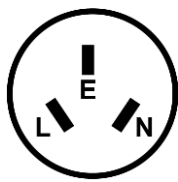

China
IT-E171



America, Canada,
Japan
IT-E172

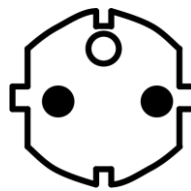

Europe
IT-E173



Britain
IT-E174

- The power cord of IT8616(15U cabinet)/IT8617(15U cabinet)/IT8624 /IT8625/IT8626/IT8627/IT8628 electronic load is shown in the next figure.



Connecting the Power Cord

- Model IT8615/IT8615L/IT8616(side plate structure)/IT8617(side plate structure) electronic load

Connect standard power cord to the AC input terminals directly. (Take the example of model IT8615)

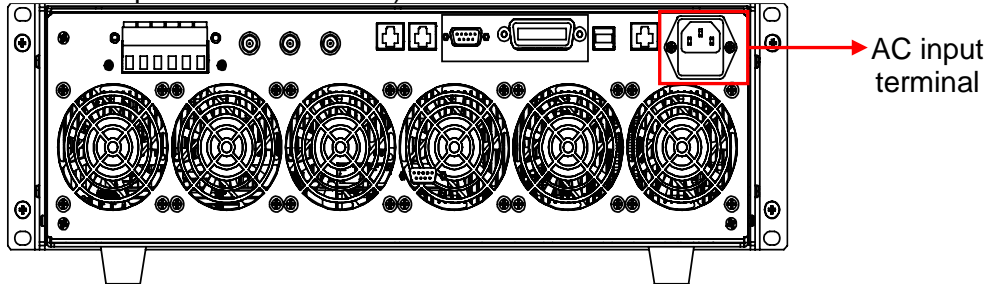

- Model IT8616(15U cabinet)/IT8617(15U cabinet)/IT8624/IT8625/IT8626 /IT8627/IT8628 electronic load (take the example of model IT8617)

Before connecting, you need to take apart the rear panel which covers the AC input terminals.

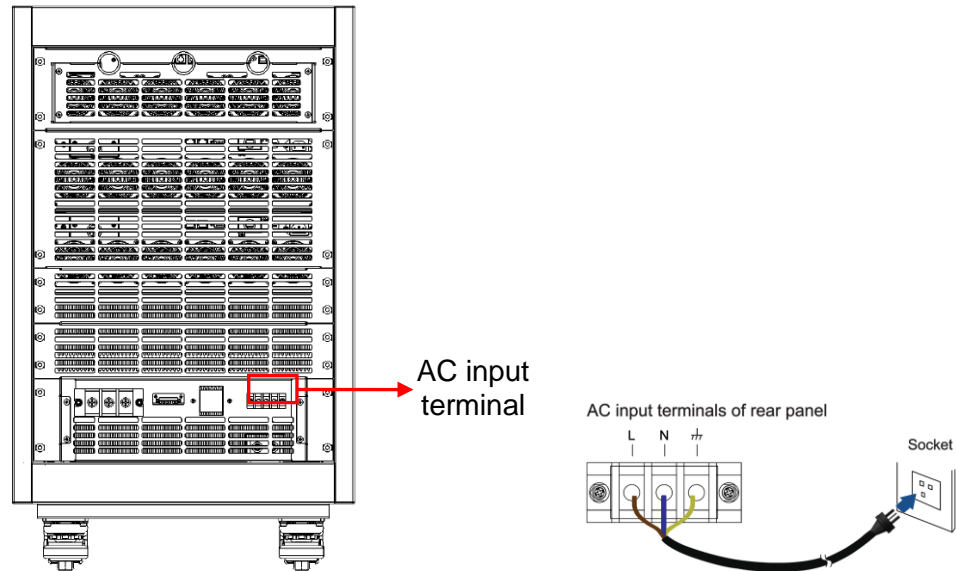

Connecting Method:

1. See the above illustration, connect one end of the AC power cord to the AC input terminal in the rear board of the electronic load. Connect the fire wire, zero line and ground to the corresponding terminal of the device. Connect the brown terminal to line (L), blue to neutral (N), and yellow-green to ground.
2. Connect the plug on the other end of the power cord to your AC power source.

1.4 Connecting Test Lines

Precautions When Wiring the Circuit

WARNING

- To prevent electric shock, turn the circuit under measurement off before connection.
- Always put the mains plug into the grounded socket. Never use an ungrounded wiring board. Before connecting the circuit, make sure the electronic load is grounded properly.
- Strip the insulation covers of the measurement cables so that when they are wired to the input terminals, the conductive parts (bare wires) do not protrude from the terminals. Also, make sure to fasten the input terminal screws securely so that cables do not come loose.
- When connecting measurement cables to the input terminals, only connect measurement cables that have safety rubber terminals that cover their conductive parts. Also, make sure to fasten the input terminal screws securely so that cables do not come loose.

CAUTION

- Use measurement cables satisfying the rated conditions and with dielectric strengths and current capacities that are appropriate for the voltage and current being measured.
- Example: when making measurements on a current of 20A, use copper wires that have a conductive cross-sectional area of 4mm² or greater.

Connecting the Measurement Circuit

IT8600 electronic load can measure electrical parameters of the test object. The specific circuit connection diagram is shown below.



- The standard equipped test of Model IT8615/IT8615L/IT8616 (side plate structure)/IT8617 (side plate structure and 15U cabinet: three masters) is as follow:

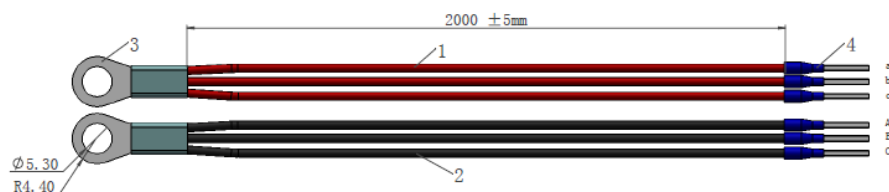

The wiring for basic measurements is as follows.

1. Respectively connect drive wires to six terminals Vs+/ V+/ V+ and Vs-/

V-/V- of the rear panel.

2. Respectively connect the other ends of wires to the anode and cathode of the test object (as shown below).

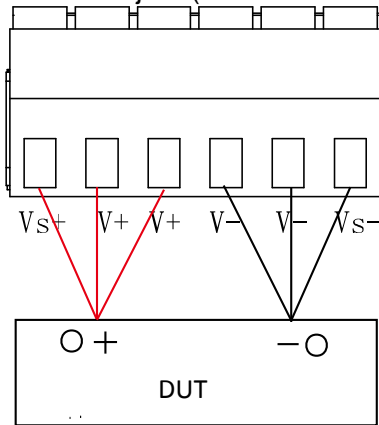

NOTE

The anode and cathode of the AC power supply has no influence on measurement data. The anode and cathode of the output end of the DC power supply must be connected properly; otherwise, measurement data will be negative.

3. Install the protection cover of the current input terminal after connecting the measurement circuit, to prevent contact with the input terminal in measurement and protect the personal safety.
- The wiring for basic measurements of Model IT8616(15U cabinet)/IT8617 (15U cabinet: one master and two slaves)/IT8624/IT8625/IT8626/IT8627 /IT8628 is as follows.

Remove the protective plates from the host and connect them to the rear midplane of the host.

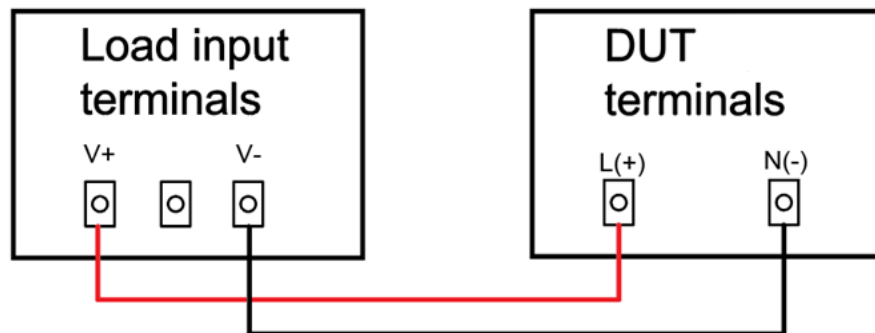

Chapter2 Quick Start

This chapter describes the power-on inspection steps of IT8600 electronic load to ensure the normal startup and use in the initial state, and the front panel, rear panel, key functions and LCD (Liquid Crystal Display) functions of IT8600 series loads to help the user know the appearance, structure and key functions before operation and better operate these loads.

2.1 Brief Introduction

The IT8600 programmable AC/DC load, using a 3U small structure to realize the input of 420V/20A/1800W, has a powerful function of data measurement. In addition to measurement of such conventional parameters as V_{rms} , V_{pk} , V_{dc} , I_{rms} , I_{pk} , I_{dc} , W , VA , VAR , CF , PF and $Freq$, the load has the unique function of voltage harmonic analysis to test harmonic interference of the test object (UPS, generator, etc.) to the power grid. At most 50 voltage harmonics can be analyzed.

The highlight of IT8600 programmable AC/DC load is the oscilloscope display, which can display the input voltage and current waveform of the test object. In the harmonic measurement mode, analysis results of the percentage of each kind of harmonics can be displayed in the bar form. Multiple display modes bring new user experience.

IT8600 programmable AC/DC load can be used in parallel connection of multiple units and three-phase parallel connection to test three-phase AC power supplies or power supplies of high power. In three-phase parallel applications, the user can select the Y-type and Δ -type connection according to the actual requirements. Flexible connection can meet various test requirements.

IT8600 programmable AC/DC load includes the standard GPIB, LAN and USB communication interface for fast and stable communication.

- Frequency range: 45-450HZ
- 7-inch LCD screen
- Parallel/three-phase control
- Oscilloscope function for display of the voltage and current waveform
- Measure V_{rms} , V_{pk} , V_{dc} , I_{rms} , I_{pk} , I_{dc} , W , VA , VAR , CF , PF and $FREQ$
- Measure the THD (V) parameters of 50 harmonics at most
- AC electronic load: CC/CR/CP mode
- DC electronic load: CC/CR/CP/CV mode^①
- External 0-10V analog control^② and voltage/current analog monitoring
- OTP, OCP, OVP, UVP and OPP protection
- LAN and USB communication interface and external USB interface

 **Note**

①②: CV mode and external 0-10V analog control function are only for IT8615 and IT8615L.

* XXX(G) is the model with built-in GPIB, the function is the same as standard model, please check with ITECH for availability.

Model	Voltage	Current	Power	Phase
IT8615(G)	50-420V	20A	1.8KW	1 ϕ

Model	Voltage	Current	Power	Phase
IT8615L(G)	15-260V	20A	1.8KW	1 ϕ
IT8616(G)	50-420V	40A	3.6KW	1 ϕ
IT8617 ^① (G)	50-420V	60A	5.4KW	1 ϕ /3 ϕ
IT8624(G)	50-420V	80A	7.2KW	1 ϕ
IT8625(G)	50-420V	100A	9.0KW	1 ϕ
IT8626(G)	50-420V	120A	10.8KW	1 ϕ
IT8627(G)	50-420V	140A	12.6KW	1 ϕ
IT8628(G)	50-420V	160A	14.4KW	1 ϕ

 **Note**

①: The IT8617 electronic load different structures support different phases, IT8617 side plate structure and cabinet structure (one master and two slaves) only support single phase, IT8617 cabinet structure (three masters) supports single phase and three phase, the phase is switchable.

2.2 Front Panel Introduction

The schematic diagram of the front panel and key functions of IT8600 AC/DC electronic load is shown below.

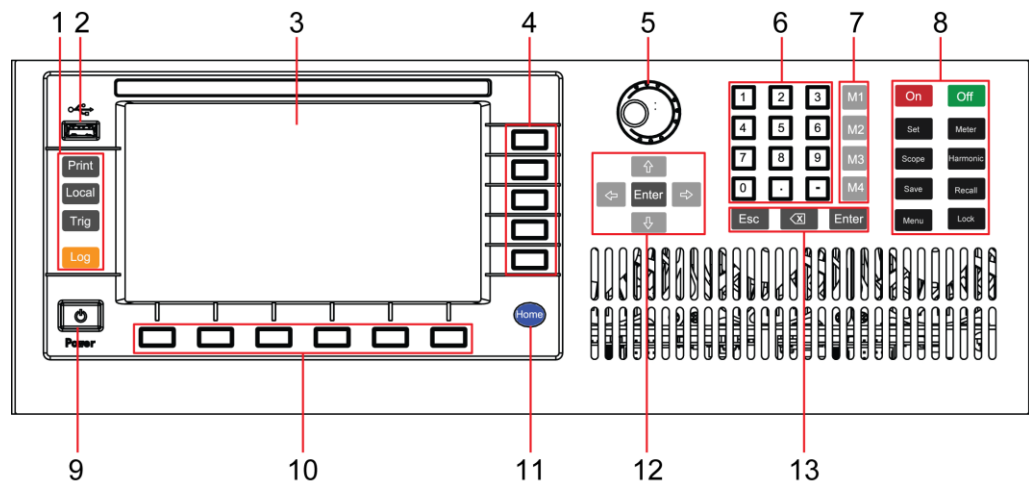

- | | |
|---------------------|-----------------------------|
| 1 Operation buttons | 8 Function key |
| 2 USB interface | 9 Power switch |
| 3 LCD display | 10 Menu key |
| 4 Menu key | 11 Home key |
| 5 Rotary knob | 12 Arrow keys and Enter key |
| 6 Number key | 13 Esc key and Enter key |
| 7 Memory key | |

2.3 Key Introduction

The key functions of the front panel and the keys in the key zones of IT8600 are shown in the following figure.

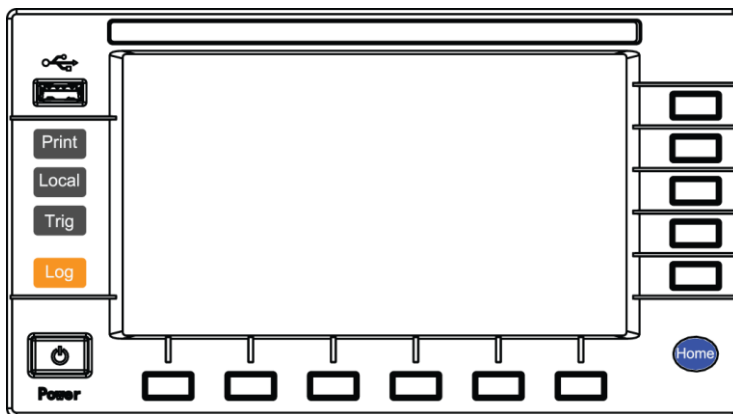

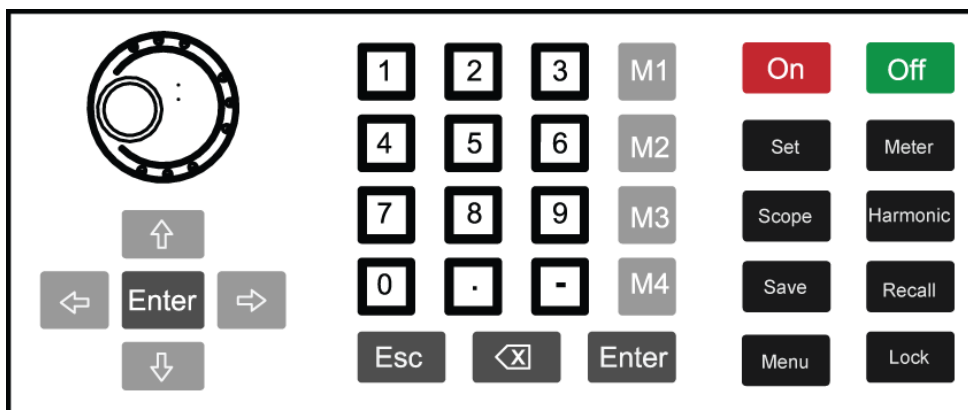

Key Details

Key Symbol	Name & Function
Print	Used for saving screen images
Local	Used for switching the remote control mode to the local mode
Trig	Used for manual trigger.
Log	Used for recording data. The recording interval can be set in second
Home	Used for going back to home page
F1-F6 R1-R5	Soft keys for corresponding screen menu operations



Key Details

Key Symbol	Name & Function
	Rotary knob: used for setting the value indicated by the cursor, selecting the voltage and current range, adjusting the waveform, etc.
	Up/Down key and Left/Right key. List edit: the programming items can be rolled by operating the Up/Down key. Corresponding information is shown on the right side and options can be selected through the soft key. Digit Edit: the programming items can be rolled by operating the Up/Down key. The digit to be edited is selected by operating the Left/Right key or through the knob. Carrying can be completed automatically.
0-9	Number key. Enter the number directly.
M1-M4	Memory key.

Key Symbol	Name & Function
	Short press it to recall the saved parameter settings of the corresponding storage areas. Long-press it to save current settings into the corresponding storage areas.
Enter	Enter key, used for confirming the message.
Esc	Cancel/Esc key.
	Used to delete the input digits in the digit editing mode.
ON	Used for enabling the load function and input.
OFF	Used for disabling the load function and input.
Set	Setting key used for setting loading parameters.
Meter	Basic metering key used for basic metering.
Scope	Oscilloscope key used for enabling the oscilloscope function.
Harmonic	Harmonic key used for enabling the harmonic function and starting harmonic measurement.
Save	Save the current load values.
Recall	Recall the saved load parameters.
Menu	Enter the System Menu and set the configuration parameters of various functions.
Lock	The key to lock the keyboard, press the key again to unlock.

2.4 Introduction to Information on the Interface

IT8600 electronic load can simulate both the AC load and DC load. Below is the basic interface information, with the basic metering interface in the AC load mode as an example.





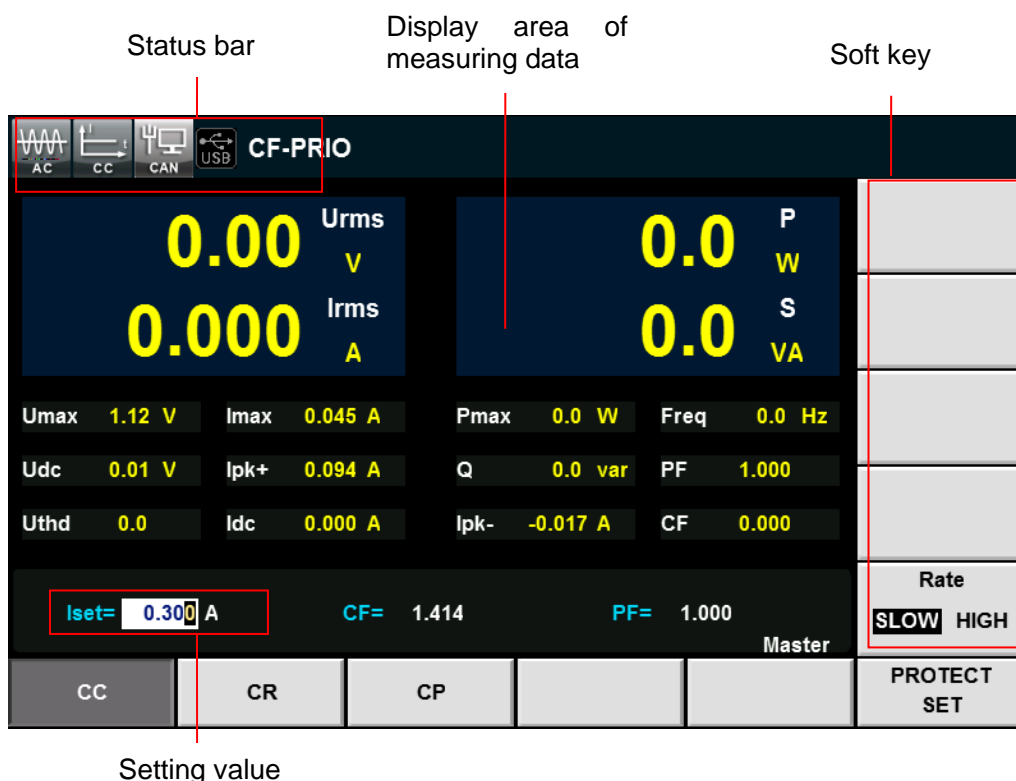



Basic metering interface

Press “Meter”, and the following initial interface of basic metering will appear.



2.5 Introduction to Interface Symbols

The interface of IT8600 electronic load will display the following symbols. All the symbols and description are listed in the table below.

Symbol	Description	Symbol	Description
SHORT	Enable the short-circuit function.	LOG	Record log.
RMT	Remote function.	CF-PRIO	CF Priority.
LOCK	LOCK key. When the key is pressed, all keys in the keyboard are disabled. Press the key again to unlock.	PF-PRIO	PF Priority.
LOL	LOCAL key, to shift local and remote operation.	CF-ONLY	Only set CF value.
FE	Frequency failure.	PF-ONLY	Only set PF value.
UV	Under Voltage Protection.		AC mode.
OVP	Over Voltage Protection.		CC mode.
OCP	Over Current Protection of the Peak value.		CP mode.
OCP	Over Current Protection.		CR mode.
OPP	Over Power Protection.		CV mode.
OTP	Over Temperature Protection.		DC mode.
LDF	Load Failure.		Turn on the timer.
EXT	External Enabled.		CAN communication

2.6 Rear Panel Introduction

- The rear panel of IT8615/IT8615L electronic load is shown in the next figure.

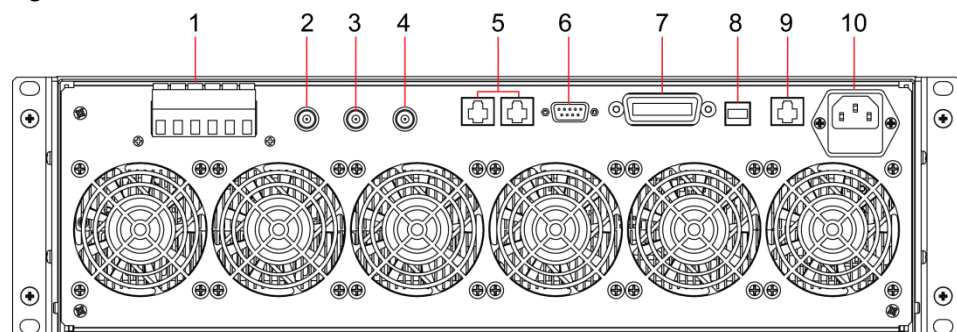

1: Input terminals and remote measurement terminals

2: Analog input terminal

6: TTL I/O: for system input/output control signal. Each pin has a serial number and the definitions are as follows: 1: Fail status 4: external on/off 9: external trigger terminals 5: earth connection.

7: GPIB communication interface

- | | |
|--|---|
| 3: Current monitor terminal | 8: USB communication interface |
| 4: Voltage monitor terminal | 9: LAN communication interface |
| 5: System bus: for master/slave control system communication | 10: AC power input socket (support 100V-240V input voltage, including fuse) |

- The rear panel of IT8616/IT8617 side plate structure is shown in the next figure. IT8616 electronic load consists of two IT8615 and IT8617 electronic load consists of three IT8615. Take the example of IT8616, the rear panel of the instrument above is the same as that of IT8615. Except the system bus terminals and AC power input sockets, the instruments below have no communication interfaces. The rear panel of IT8616 is shown as below:

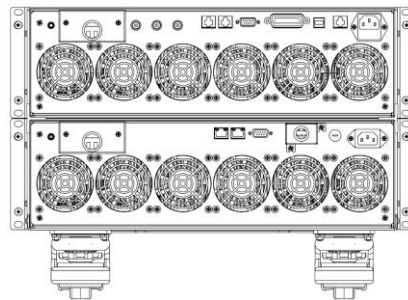

- The rear panel of IT8616(15U cabinet)/IT8617 (15U cabinet: one master and two slaves) is shown in the next figure.

Take the example of IT8617, before connecting the communication terminals, you need to take apart the rear panel which covers the communication terminals by using a screwdriver. The communication terminals of 15U cabinet are the same as those of the side plate structure. Before connecting the load input terminals and AC power input terminals, you also need to take apart the rear panel which covers them by using a screwdriver. The figure below shows the rear panel.

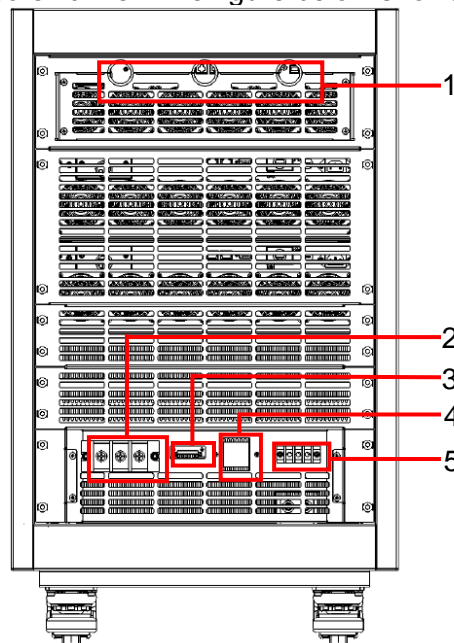

1. Communication interface threading hole
2. Load input terminals

3. Remote measurement terminals
 4. Power master switch
 5. AC power input terminals
- The rear panel of IT8617 15U cabinet (three masters) is shown in the next figure.

Before connecting the communication terminals, load input terminals and remote measurement terminals, you need to take apart the rear panel which covers the communication terminals by using a screwdriver. These terminals are the same as those of IT8615.

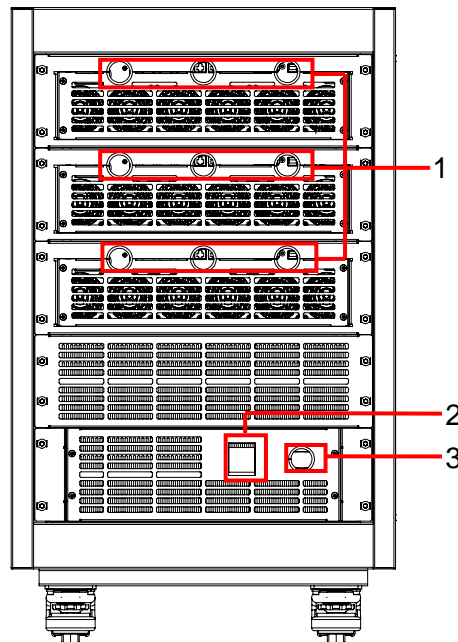

1. Communication interface and test line threading hole
 2. Power master switch
 3. AC power cord threading hole
- The rear panel of IT8624/IT8625/IT8626/IT8627/IT8628 is shown in the next figure. (Take the example of IT8625).

Before connecting the communication terminals, you need to take apart the rear panel which covers the communication terminals by using a screwdriver. IT8620 series electronic loads have two groups of system bus interfaces. One of them is used to connect the internal instruments which make up the cabinet, which is connected well when delivered; the other is used to connect between the cabinets to realize the parallel or three-phase function.

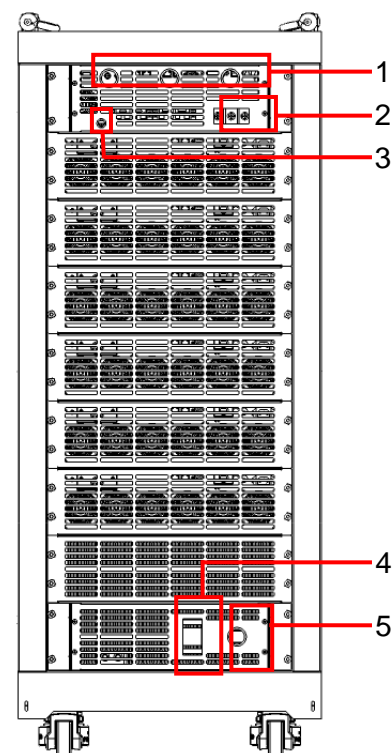

1. Communication interface threading hole
2. Load input terminal threading hole
3. Remote measurement terminal threading hole
4. Power master switch
5. AC power cord threading hole

Remove the protective plates from the host and connect them to the rear midplane of the host.

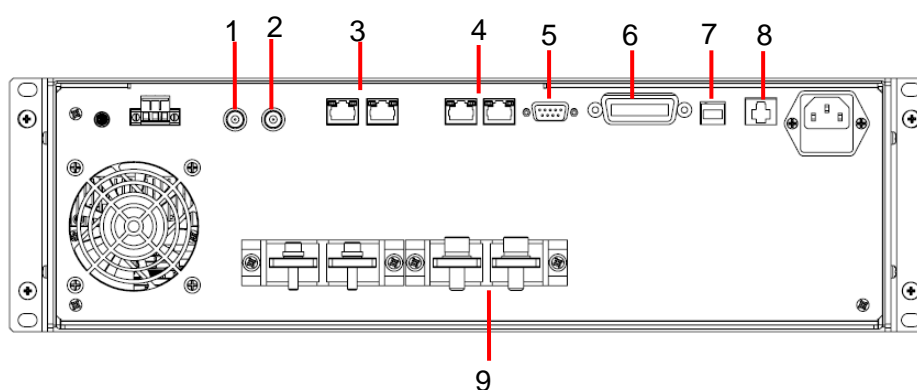

- | | |
|--|---|
| 1: Current monitor terminal | 5: RS232 interface |
| 2: Voltage monitor terminal | 6: GPIB interface(only for IT8600G) |
| 3: Ext_BUS, parallel or three-phase connection | 7: USB interface |
| 4: INT_BUS, master and slave connection | 8: LAN interface |
| | 9: Load input interface, connect to DUT |

2.7 Power-on Self-test

A successful self-test indicates that the purchased product meets delivery standards and is available for normal usage. Before operation, please confirm that you have fully understood the safety instructions.

Introduction of Switch

You can turn on the instrument by switch. Descriptions of the switch are as follows:



If the instrument is the cabinet type, the rear panel of the cabinet provides a master power switch. The relationships between the device status and switch status are listed in the following table.

Master switch status	Desperate switch status	Device status
ON	ON	ON
ON	OFF	OFF
OFF	ON	OFF
OFF	OFF	OFF

Power-On

The normal power-on process of the electronic load is as follows:

1. Properly connect the power cord and press **[Power]** to power on the instrument.

The LCD screen displays the electronic load version and time information.

2. After initialization, the LCD screen displays the following information.



 NOTE

In case of any error, self-test will stop. Contact ITECH sales agent or technical service engineer.

3. Press [**Menu**], and the LCD screen of the electronic load displays the system information.

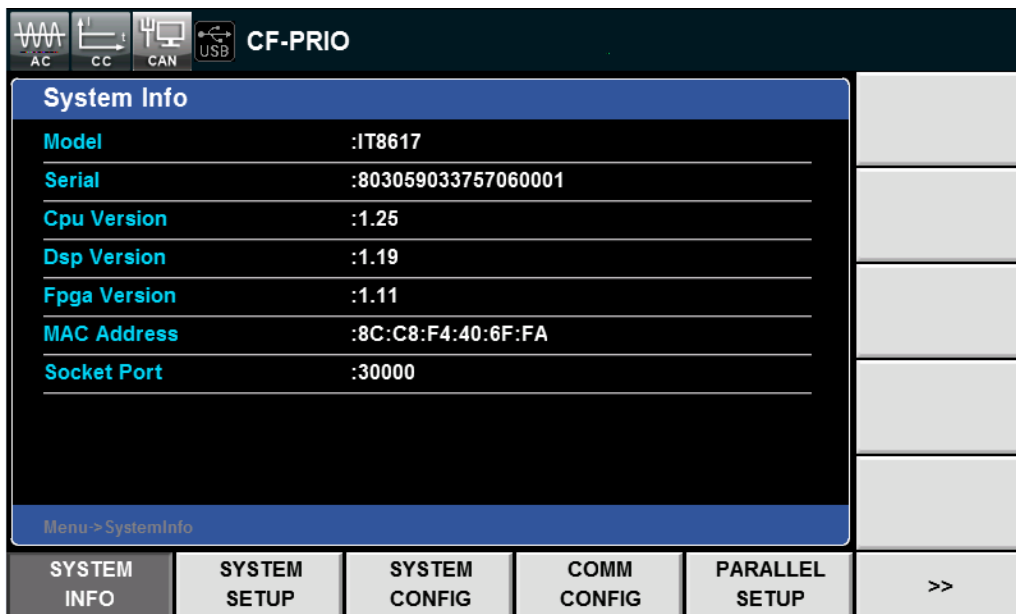

System Self-Test

The self-test function of the electronic load can be enabled to test the Lcd, Led, Dsp and Backup Ram. Specific steps are as follows:

1. Press [**Menu**] to enter.
2. Press [**>>**] in this interface, and the system menu is scrolling.
3. Select [**SELF TEST**] in this interface, and the system enters the self-test interface.



4. Press [**START**] and the system starts self-test, including Lcd, Led, Dsp and Backup Ram.
5. If **OK** appears behind the self-test item, the item has passed self-test. If **NG**

appears, the user should check self-test results, such as the clarity of LED display, etc.

Input Inspection

The minimum AC input voltage of IT8600 AC/DC electronic load is 50Vrms (The minimum AC input voltage of IT8615L is 15V). The minimum DC input voltage of IT8600 AC/DC electronic load is 10Vrms. When any load is applied on the AC/DC electronic load and the input voltage setting is more than the minimum value, the current and CF value should be adjusted according to the present load operation; otherwise, under voltage protection of the AC/DC electronic load will be enabled and no load can be applied.

1. Connect the basic measurement circuit according to the connection method specified in 1.4 Connecting Test Lines.
2. Set the output voltage and current at the power supply end.
3. Press **[Set]** to set the on-load current, resistance or power at present at the load end.

NOTE

For details of the current, resistance or power settings in various operating modes, refer to chapter 4 Load Functions.

4. Press **[Enter]** to confirm.
5. Press **[On]** to enable the load input. The current is absorbed at the beginning of on-load operation.

Replace the Fuse

During normal use of the instrument, you need to replace a blown fuse where necessary by following the procedures below. The fuse of IT8615/IT8615L and IT8616/IT8617 side plate structure can be replaced by yourself, but the fuse of other models needs to be replaced by professional.

1. First pull out the power cord, and then take out the fuse block from the power cord jack with a small screwdriver, as shown below:



2. Have a visual inspection of the fuse to see whether it is burnt out; if yes, replace it with another fuse of the same specification. Refer to the corresponding technical specifications for fuse rating.
3. After replacement, mount the fuse block to the original position, as illustrated below:

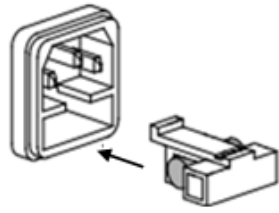

Chapter3 Basic Operations

This chapter describes operations of the keys on the front panel of the electronic load. The electronic load must be in the local mode when controlled by the front panel. The default mode is the local mode after the electronic load is turned on. In the local mode, the user can enable all functions of the load through the front panel.

3.1 Input On/Off Control

[On]/[Off] button on the front panel are used to control input switch. [On] button lighted indicates the load input is on and the [Off] button lighted indicates the load input is off. The initial state of electronic load is OFF.

3.2 Key Lock Function

Press [Lock] key to lock the front panel keys, LOCK label will display in LCD screen. In this condition, the other keys are invalid except Lock key. Press [Lock] key again to unlock.

3.3 Menu Configuration Function

System configuration such as the load mode and general settings are set in the load menu. Press "MENU" on the front panel to set the system menu. You can set the following menu items.

Menu	Menu Setting	
SYSTEM	SYSTEM INFO	
	Instrument information	system
	Model	Instrument model
	Serial	Instrument SN
	Cpu Version	The version of Cpu
	Dsp Version	The version of Dsp
	Fpga Version	The version of Fpga
	MAC address	Network hardware address
	Socket Port	Port number
	SYSTEM SETUP	
	System setup	
	Mode select	AC/DC mode selection
	CF/PF setting	CF/PF setting: CF/PF/BOTH
	CF/PF Priority	CF/PF setting priority: CF/PF
	Timing Mode	Timing mode enabling/disabling: Off/ On
	Short Function	Short-circuit function enabling/disabling (Disable/ Enable), only for the load with DC mode
	Harmonic Formula	Harmonic formula: THDF/ THDR
	Peak Hold Mode	Peak holding mode: Off/ On
	Power On Setting	Power-on status: SAV0/RST ● If Rst is selected, factory settings are recovered after each start-up

		<ul style="list-style-type: none"> If Sav0 is selected, the voltage and current are the values in the file FILE0 	
Ext prog		External port: Off/ On Only IT8615 and IT8615L are with the function	
Protect Auto Clear		Clear UV and FE protection state under AC load automatically: Off/ On	
Average Count(2^n)		Average times of sampling rate in measurement function. The setting range is 1 to 16	
Inter Loop		Set the internal loop state of load. CC: constant current CR: constant resistance	
SYSTEM CONFIG		System configuration	
Brightness		Set the screen brightness within the range of 1 to 9	
Beep		Set the keyboard sound: OFF/ ON	
COMM CONFIG		Communication configuration	
SCPI protocol		SCPI protocol: Default/ Extended <ul style="list-style-type: none"> Default: default command Extended: Extension command 	
Mode	USB	Select the USB communication interface	
	GPIB	GPIB Address	Select the GPIB communication interface within the range of 0 to 30 (Only for IT8600G series)
	LAN	IP Mode	IP Mode: MANU/ DHCP <ul style="list-style-type: none"> MANU: manual settings DHCP: automatic allocation
		Socket	Socket port within the range of 2000 to 65535
		IP Address	Set the IP address
		Subnet Mask	Set the subnet mask
		Gateway	Set the gateway
PARALLEL SETUP		Parallel setup (IT8615/IT8615L)	
Operating Mode		Operating Mode: Single/ Parallel <ul style="list-style-type: none"> Single: single mode Parallel: parallel mode 	
Master/Slave		Set up the Slave/ Master <ul style="list-style-type: none"> Master Slave Only valid when the operating mode is set to Parallel	
Single/Three Phase		Set the phase: Single/ A+B+C <ul style="list-style-type: none"> Single: single phase A+B+C: three phase Only valid when the operating mode is set to Parallel	
Total Slave Unit		Total Slave Unit Only valid when the operating mode is set to Parallel	
PARALLEL SETUP		Parallel setup (IT8620 Series)	
Operating Mode		Operating Mode: Single/ Parallel <ul style="list-style-type: none"> Single: single mode 	

		<ul style="list-style-type: none"> ● Parallel: parallel mode
Phase Class		Set the phase class: Single/ A+B+C <ul style="list-style-type: none"> ● Single: single phase ● A+B+C: three phase Only valid when the operating mode is set to Parallel
Phase/Position		Set the phase: <ul style="list-style-type: none"> ● Master-A(1) ● Slave-B(2) ● Slave-C(3) Only valid when the operating mode is set to Parallel
Total Unit		Total unit number Only valid when the operating mode is set to Parallel
SYSTEM INITIAL		System initialization
Meter		Initialize the measurement function
Scope		Initialize the waveform display function
Harmonic		Initialize the harmonic measurement function
Setup		Initialize the setup parameter
System		Initialize the system parameter
SELF TEST		System self-test
System Self_Test		self-test items: LCD/ LED/ DSP/ Backup Ram
PRODUCT INFO		Display the parallel unit product information Only IT8615/IT8615L/IT8616/IT8617 are with this menu item
RESTART DEVICE		Restart the device Only IT8620 series are with this menu item

3.4 Configuration Save/Recall

IT8600 electronic load can save all the present parameter settings into ten nonvolatile memories so that the operator can easily and rapidly recall such parameter settings. The storage files are FILE0 to FILE9.

The user can long-press M1 to M4 on the front panel to save the present parameters and short-press M1 to M4 to recall the saved parameters. The access to M1 to M4 is equivalent to that to FILE1 to FILE4.

Operating steps

To save the present parameter for direct recalling in the future, refer to the following steps.

Example: The constant current (CC) of the electronic load is 1A, CF is 2.0 and PF is 1.000. Save the present parameters into Register 3 and recall them.

- Save
1. Set the parameters and press **[Enter]** to confirm them.
 2. Press **[Save]** to save the data. Set "Save file to:". Set the FILE number to be saved at present as 3. Press **[Enter]** to confirm the file number.

3. Press **[Enter]** to save.

The user can long-press M3. When the system prompt “Save3 is performed” appears, the present parameter settings are saved in Register 3.

- Recall
1. Press **[Recall]**. When the system prompts “Recall file from:” appears, select the file number saved previously, such as 3. Press **[Enter]** to confirm the file number.
 2. Press **[Enter]**, and the system displays the recalled data.

The user can short-press M3 and the system prompt “Recall3 is performed” appears. Then the system will display the recalled data.

3.5 Screen Capture Function

The electronic load has the function of screen capture. When **[Print]** on the front panel is pressed, the electronic load will capture the present screen and save it into the external storage device.

3.6 Local/Remote Switching Function

The electronic load has two operating modes, i.e. local and remote mode, which can be switch according to the communication command. The default mode is the local mode.

Local mode: you can use keys on the electronic load to perform related operations.

Remote mode: the electronic load is connected to PC and related operations are performed through PC. In the remote mode, all the keys on the panel cannot be enabled except the “Local” key. You can press the “Local” key to enable the local mode.

3.7 Load Switching

IT8600 electronic load can simulate both AC load and DC load. The user can set the load mode currently simulated in the system menu. Detailed operations are as follows:

1. Press **[Menu]** to enter the system menu setting interface.
2. Press **[SYSTEM SETUP]** to enter the system setting interface.
3. Press the Up and Down key to move the cursor and select “Mode select”.
4. The corresponding options of the parameter are displayed on the right side. Press the corresponding soft key to select AC or DC.

AC: indicating that the load is the AC load when the present function is enabled.

DC: indicating that the load is the DC load when the present function is enabled.

5. Press **[Enter]** to confirm.

3.8 Operating Mode

When the AC load is simulated, you can press **[Set]** on the front panel, and then select the AC load operating mode by pressing the soft keys corresponding to

CC, CR and CP in the setting interface. When the DC load is simulated, you can press **[Set]** on the front panel, and then select the DC load operating mode by pressing the soft keys corresponding to CC, CR, CP and CV in the setting interface. After selecting the operating mode, you can easily set the voltage, current, resistance, power and other information.

All data are adjusted according to the current, power, CF and PF value in any mode. In the local mode, all data can be set in the front panel.

When the parameter is edited, the text or area edited or selected in the interface will flash to remind you of the value edited or set at present.

NOTE

The CV operating mode is only for IT8615 and IT8615L.

3.9 Data Recording Function

IT8600 electronic load can record all measurement data. The user can press **[Log]** and set the recording interval (in second). You can press Start to start data recording. The electronic load can record present measurement data at intervals and save such data into the peripheral memory disc. All data are saved in files ending in CSV. The file name is IT8615Meter.csv, and the file contents are shown below.

Date&time	Idc	Irms	Inax	Ipk+	Ipk-	Udc	Urms	Umax	P	S	Q	Pmax	R	Freq	CF	PF	Uthd
2000-01-13 07	0	0	0	0	0	0	0	0	0	0	0	0	0	0	0	0	0
2000-01-13 07	0	0	0	0	0	0	0	0	40695	0	0	0	0	26752	0	0	22039
2000-01-13 07	0	0	0	0	0	0	0	0	40695	0	0	0	0	26752	0	0	22039
2000-01-13 07	0	0	0	0	0	0	0	0	40695	0	0	0	0	26752	0	0	22039
2000-01-13 07	0	0	0	0	0	0	0	0	40695	0	0	0	0	26752	0	0	22039
2000-01-13 07	0	0	0	0	0	0	0	0	40695	0	0	0	0	26752	0	0	22039
2000-01-13 07	0	0	0	0	0	0	0	0	40695	0	0	0	0	26752	0	0	22039
2000-01-13 07	0	0	0	0	0	0	0	0	40695	0	0	0	0	26752	0	0	22039
2000-01-13 07	0	0	0	0	0	0	0	0	40695	0	0	0	0	26752	0	0	22039
2000-01-13 07	0	0	0	0	0	0	0	0	40695	0	0	0	0	26752	0	0	22039
2000-01-13 07	0	0	0	0	0	0	0	0	40695	0	0	0	0	26752	0	0	22039
2000-01-13 07	0	0	0	0	0	0	0	0	40695	0	0	0	0	26752	0	0	22039
2000-01-13 07	0	0	0	0	0	0	0	0	40695	0	0	0	0	26752	0	0	22039
2000-01-13 07	0	0	0	0	0	0	0	0	40695	0	0	0	0	26752	0	0	22039
2000-01-13 07	0	0	0	0	0	0	0	0	40695	0	0	0	0	26752	0	0	22039
2000-01-13 07	0	0	0	0	0	0	0	0	40695	0	0	0	0	26752	0	0	22039
2000-01-13 07	0	0	0	0	0	0	0	0	40695	0	0	0	0	26752	0	0	22039
2000-01-13 07	0	0	0	0	0	0	0	0	40695	0	0	0	0	26752	0	0	22039
2000-01-13 07	0	0	0	0	0	0	0	0	40695	0	0	0	0	26752	0	0	22039
2000-01-13 07	0	0	0	0	0	0	0	0	40695	0	0	0	0	26752	0	0	22039
2000-01-13 07	0	0	0	0	0	0	0	0	40695	0	0	0	0	26752	0	0	22039
2000-01-13 07	0	0	0	0	0	0	0	0	40695	0	0	0	0	26752	0	0	22039
2000-01-13 07	0	0	0	0	0	0	0	0	40695	0	0	0	0	26752	0	0	22039

3.10 Online Load Setting

The load has two modes for modification of online settings, so that the user can directly modify the current setting when the input is ON. Settings can be modified in two ways:

- Rotate the knob: rotate the knob towards the Decrease direction to decrease the current, resistance and power and the Increase direction to increase the current, resistance and power.
- Use the cursor and number keys: press the Up and Down key to select the parameter to be set, and directly press the numeric keypad to input the setting.

3.11 Timing Mode

The loading time of IT8600 electronic load can be set within the range from 1 s to 60000 s. When the timing mode is enabled and the time is set, the electronic load will calculate the time during loading. When the loading time reaches the set time, the input will be turned off automatically.

The user can enable the timing mode in the system setting menu, as shown below.

1. Press [**Menu**] to enter the system setting interface.
2. Select the soft key corresponding to [**SYSTEM SETUP**] to enter the system parameter setting interface.
3. Press the Up and Down key and select the setting of “Timing Mode”. Press the soft key corresponding to [**On**] on the right side to enable the timing mode.
4. Go back to the main interface. The interface will display the timing parameters. Rotate the knob or press the numeric keys to set the loading time.



3.12 Protection Function

The load includes the following protection functions: overvoltage protection (OVP), overcurrent protection (OCP), overpower protection (OPP), over-temperature protection (OTP), out-of-range frequency protection, undervoltage protection and loading failure protection. Any protection or warning will be alarmed or displayed. In case of OVP, OCP, OPP, OTP and warning, the input will be turned off and the buzzer will send the alarm. You can unlock the protection status and press [**Enter**] to reset the protection function. In case of loading failure, press the power switch key to restart the electronic load. If loading failure still occurs after restart, contact the technical service engineer of ITECH.

CAUTION

To protect the electronic load from damage, the input voltage must not exceed the maximum input voltage of the electronic load.

Setting of protection function

The OCP (Current Rms Protect), OCPP (Current Peak Protect) and OPP (Power Protect) functions of IT8600 AC/DC load can be set.

1. Press [**Set**].

- Press **[PROTECT SET]** in the interface to enter the “Protect Set” interface, where you can set the following protection.

Protection Type	Status	Upper Limit	Delay Time
OCP (Current Rms Protect)	On: to enable protection Off: to disable protection	Current for OCP protection	Overcurrent time: when the actual time exceeds the delay time, the protection will be enabled.
OCP (Current Peak Protect)	-	Peak current for protection	-
OPP (Power Protect)	On: to enable protection Off: to disable protection	Power for protection	Overcurrent time: when the actual time exceeds the delay time, the protection will be enabled.

Overvoltage protection (OVP)

If the voltage of the circuit exceeds the voltage protection value (refer to the Technical Specifications for the detailed value), the load will be OFF immediately, and the buzzer will sound, the OV and VF will be set in the status register, and OVP will be displayed on the load screen and kept until the load is reset. In case of overvoltage protection, the VF pin of No. 9 pin connector on the rear panel of the load will output high TTL level, and the output of the tested power supply can be controlled by the VF pin.

Clearing the overvoltage protection:

Check whether the voltage of the test object is within the rated voltage range of the load. If the voltage of the test object is beyond the rated voltage range, disconnect the test object, and press any key on the front panel. Then OVP on the load screen will disappear, and the load will exit the OVP status.

Overcurrent protection (OCP)

The electronic load has two kinds of overcurrent protection: hardware overcurrent protection and software overcurrent protection.

Hardware overcurrent protection: the maximum loading current will be limited by hardware to be about 110% of the current range. Once the hardware overcurrent protection is enabled, the OC position in the status register will be set. When the hardware overcurrent protection is unlocked, the OC position in the status register will be reset. The present ON/OFF status of the load cannot be changed in the case of hardware overcurrent protection.

Software overcurrent protection: the user can set the software overcurrent protection value of the load.

Clearing overcurrent protection:

Check whether the current of the test object is within the rated current range of the load or within the protection current setting range. If the current of the test object is beyond the rated current range or the protection current range, disconnect the test object, and press any key on the front panel (or send the

command “PROTection:CLEar”). Then OCP on the load screen will disappear, and the load will exit the OCP status.

Overpower protection (OPP)

The electronic load has two kinds of overpower protection: hardware overpower protection and software overpower protection.

Hardware overpower protection: the user can set the hardware overpower protection value, and the load power will be limited at the present power by the hardware. The present ON/OFF status of the load cannot be changed in hardware overpower protection.

Software overpower protection: the user can set the software overpower protection value of the load.

Clearing overpower protection:

Check whether the power of the test object is within the rated power range of the load or within the protection power setting range. If the power of the test object is beyond the rated power range or protection power setting range, disconnect the test object, and press any key on the front panel (or send the command “PROTection:CLEar”). Then OPP on the load screen will disappear, and the load will exit the OPP status.

Over-temperature protection (OTP)

When the temperature of the power component in the load exceeds 85°C, the temperature protection will be enabled. In this case, the load will be automatically OFF, and the LCD will display OTP. At the same time, the OT and PS position in the status register will be set and kept until the load is reset.

Clearing over-temperature protection:

When the load temperature decreases to the protection temperature, press any key on the front panel (or send the command “PROTection:CLEar”). Then OTP on the load screen will disappear, and the load will exit the OTP status.

Out-of-range frequency protection

When the measured frequency is beyond the frequency range (45HZ to 450HZ), “FREQ ERR” will be displayed.

Undervoltage protection

When the load is applied and current is sinking, the voltage will decrease instantly as a result of impedance of the test unit. When the voltage is lower than the required input voltage, loading will be stopped to protect the load and test unit, and the UV prompt will appear on the interface. The user should decrease the loading current or CF value to ensure normal operation.

Loading failure

Loading failure occurs in the following cases:

- The input voltage is 0 during loading;
- The voltage is reduced to 0 during loading;
- The load hardware is abnormal;
- The voltage and loading current fluctuates continuously.

3.13 Remote Measurement Function

In the loading mode, if high current is required or the wire is long, a great voltage drop will occur on the connecting wire between the test object and load terminal. To ensure the measurement accuracy, a remote measurement terminal is set on the rear panel of the electronic load to be used for measuring the output terminal voltage of the test object.

When the load is used for measuring battery discharge in actual applications, the voltage drop of the wire will lead to voltage inconsistency of both ends and inconsistency of the cutoff voltage of load and the actual voltage of battery, resulting in inaccurate measurement.

Take the example of IT8615 electronic load, the schematic diagram of remote measurement terminals is as follows. The actual terminals are subject to the real instrument.

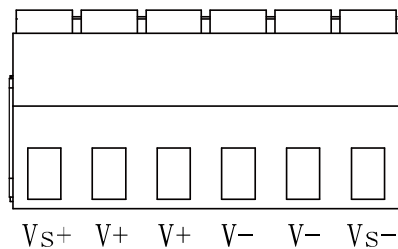

V_S+/V_S- : remote measurement terminal. When the remote measurement function is used, V_S+ and V_S- are connected to the test object.
 $V+/V-$: input terminal.

Use remote sense:

- Remote measurement function is always applied to connection of test lines for Model IT8615/IT8615L/ IT8616 (side plate structure)/ IT8617 (side plate structure and three masters in 15U cabinet). Refer to 1.4 Connecting Test Lines for the wiring.
- The operations for Model IT8616 (15U cabinet)/IT8617 (one master and two slaves in 15U cabinet)/IT8624/IT8625/IT8626/IT8627/IT8628 are as follows:
 1. Disconnect the wires/short clips between $V+$ and V_S+ , $V-$ and V_S- .
 2. Connect the V_S+ to the DUT's L terminal, and connect the V_S- to the DUT's N terminal.
 3. Connect the drive wires from the rear panel terminals to the tested equipment.



NOTE

In order to ensure the stability of the system, using armored twisted pair cable between the remote sense terminals and DUT.

The schematic diagram of remote sense measurement is shown as follow.

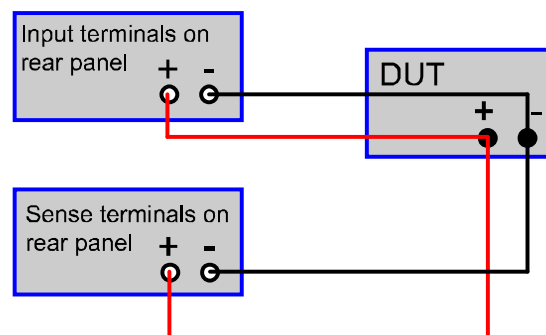

3.14 External On/Off Control

The input switch of IT8600 electronic load can be controlled by the external TTL level. When the external level is low, the load switch will be in the On position; otherwise, the load switch will be in the Off position. The input switch of the load can only be controlled by the external TTL level.

For IT8620 series, including IT8624, IT8625, IT8626, IT8627 and IT8628, the user must set the “Ext Prog” item into the “On” state in the menu before using this function.

1. Press **[Menu]** to enter the menu setting interface.
2. Press the soft key corresponding to **[SYSTEM SETUP]** to enter the system setting interface.
3. Press the Down key and select “Ext Prog”. Set the “Ext Prog” item into the “On” state.
4. Press **[Esc]** to go back.

3.15 External Analog Quantity Control (Only for IT8615 /IT8615L)

IT8600 electronic load has an analog input terminal. Under CC mode, loading current of the electronic load can be controlled by analog quantity terminal on rear panel. Connect 0-10V adjustable voltage at the Ext-prog terminal to analog input from 0- full range. (in AC mode: 0-10V corresponds to 0-60Apeak, in DC mode: 0-3.4V corresponds to 0-20A).

Attention: In DC mode, the current is limited by the set value of the instrument panel, so the Iset value should be greater than the set value of the analog quantity when controlling the analog quantity.

The user must set the “Ext Prog” item into the “On” state in the menu before using this function.

5. Press **[Menu]** to enter the menu setting interface.
6. Press the soft key corresponding to **[SYSTEM SETUP]** to enter the system setting interface.
7. Press the Down key and select “Ext Prog”. Set the “Ext Prog” item into the “On” state.
8. Press **[Esc]** to go back.

3.16 Voltage/Current Monitoring (I/V Monitor)

IT8600 electronic load has an output terminal for voltage and current monitoring. The user can connect this terminal to the oscilloscope of the BNC terminal to observe the current and UUT output voltage of the load. This function is effective when the voltage and current changes are monitored according to the waveform.

For the voltage/current monitoring output terminal, the 0-10V analog output signals represent the input voltage/current from 0 to the rating in the corresponding channel where the terminal is located.

3.17 Parallel Function

IT8600 programmable AC/DC load can be used in parallel connection of multiple units of the same models to test power supplies of high power. In

parallel application, AC and DC operations can be carried out in the CC/CR/CP mode.

- IT8615/IT8615L electronic load: Up to nine units of the same voltage and current rating can be connected in parallel.
- IT8616 electronic load: Up to four units of the same voltage and current rating can be connected in parallel.
- IT8617 electronic load: Up to three units of the same voltage and current rating can be connected in parallel.
- IT8620 series (IT8624/IT8625/IT8626/IT8627/IT8628): Up to three units of the same voltage and current rating can be connected in parallel.

Take the example of IT8615 electronic load, the schematic diagram of parallel connection is as follows. When you connect system bus, the Terminating Resistor is a must for the first load unit and the last load unit.

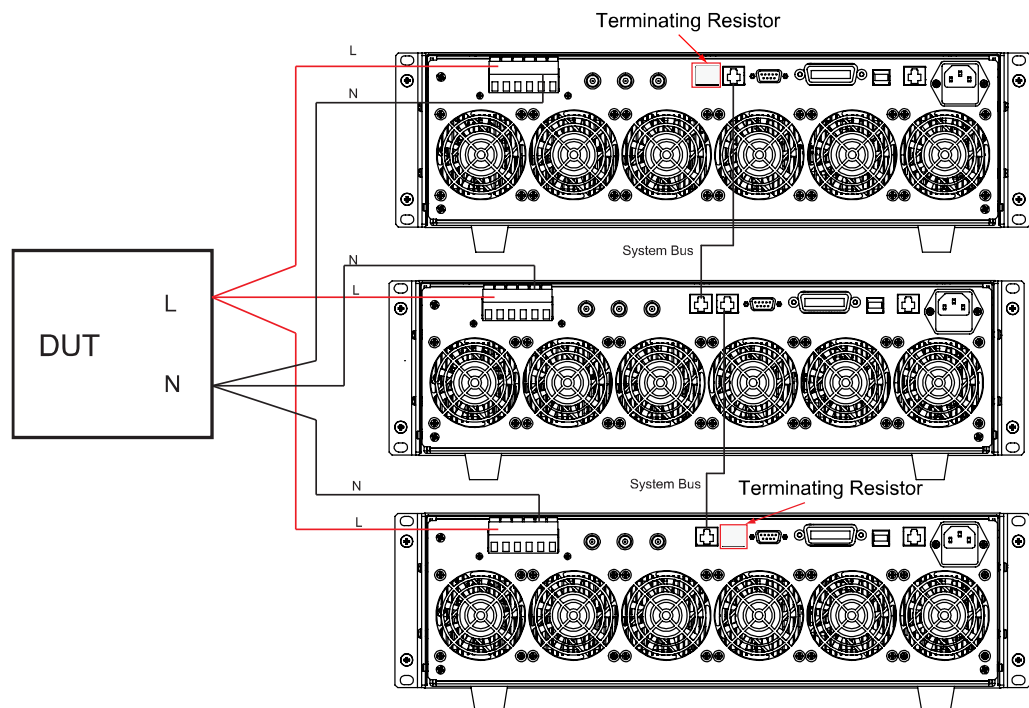

The IT862X series System Bus ports are different from the IT861X series. When connecting the parallel communication cables between IT862X cabinets, connect the EXT_BUS according to the following diagram.

When you connect system bus, the Terminating Resistor is a must for the first load unit and the last load unit.

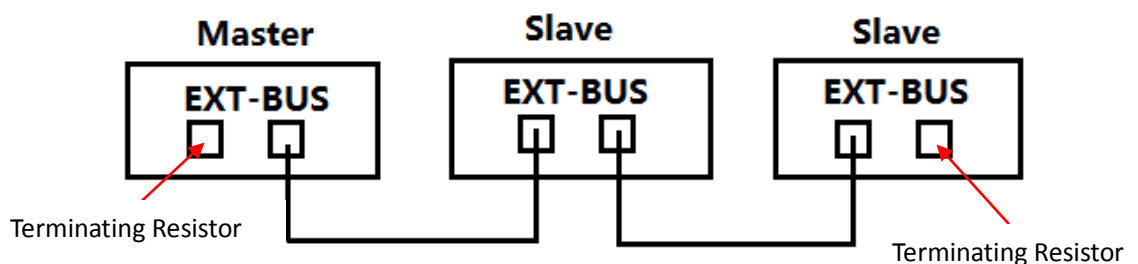

The Terminating Resistor is a PLUG with a 120 ohm resistor inside. The Termination Resistor does not distribute with the standard unit. If the user purchases multiple standard units and parallels them, the Termination Resistor need to be purchased separately.

Configure the internal relationship of instruments after connecting the system bus. In the parallel mode, the master and slaves are determined by the instrument setting. If the instrument is set to Master, the present AC load is the master unit, and if the instruments are set to Slave, the AC loads are slaves. The user should set the total number of slave or unit in master to determine the electronic load power in the present mode.

When the AC load is set in the parallel operation mode, slaves should be set with priority to correctly set the total number of parallel units during master unit setting.

The configuration interface of IT8620 series and IT8615/IT8615L are not the same. The specific setting steps are as follows.

- Take the parallel connection of two IT8615 electronic loads as an example. Select one electronic load as the slave.
 1. Press **[Menu]** to enter the system menu setting interface.
 2. Select **[PARALLEL SETUP]** to enter the parallel setting interface.
 3. Press the Up and Down key to select the “Operating Mode” > “Parallel”.
 4. Set “Master/Slave” as Slave, as shown below:



5. Press **[Enter]** to save the setting. Select one electronic load as the master.
 1. Press **[Menu]** to enter the system menu setting interface.
 2. Select **[PARALLEL SETUP]** to enter the parallel setting interface.
 3. Press the Up and Down key to select the “Operating Mode” > “Parallel”.
 4. Set “Master/Slave” as Master.
 5. Set “Total Slave Unit” as 1, as shown below:

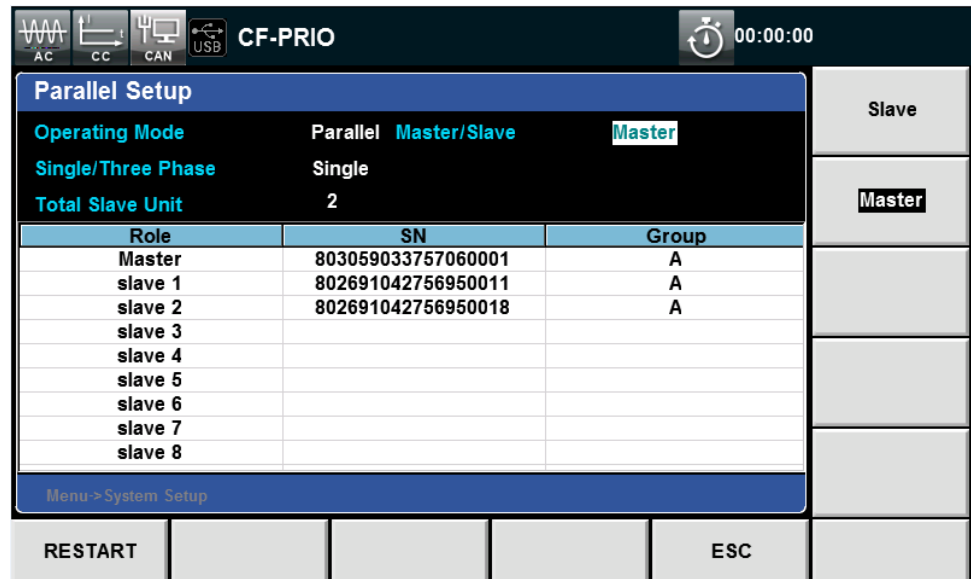

AC CC CAN USB CF-PRIO 00:00:00

Parallel Setup

Operating Mode Parallel Master/Slave **Master**

Single/Three Phase Single

Total Slave Unit 2

Role	SN	Group
Master	803059033757060001	A
slave 1	802691042756950011	A
slave 2	802691042756950018	A
slave 3		
slave 4		
slave 5		
slave 6		
slave 7		
slave 8		

Menu > System Setup

RESTART ESC

6. Press **[Enter]** to save the setting.

After saving the settings, the user must power off two electronic loads and power on again. The interfaces of master and slave are shown as below.

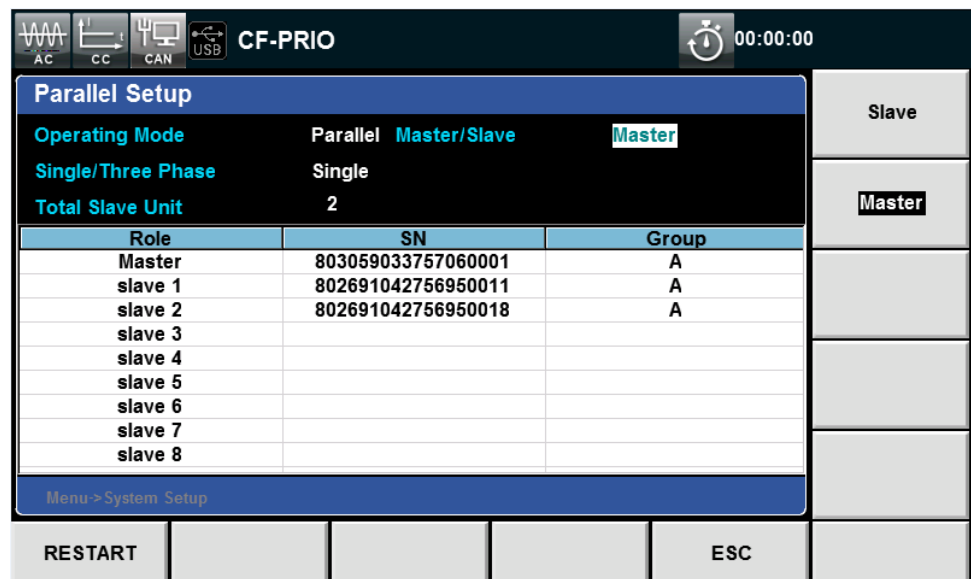

AC CC CAN USB CF-PRIO 00:00:00

Parallel Setup

Operating Mode Parallel Master/Slave **Master**

Single/Three Phase Single

Total Slave Unit 2

Role	SN	Group
Master	803059033757060001	A
slave 1	802691042756950011	A
slave 2	802691042756950018	A
slave 3		
slave 4		
slave 5		
slave 6		
slave 7		
slave 8		

Menu > System Setup

RESTART ESC



- Take the parallel connection of three IT8628 electronic loads as an example.

Select two electronic loads as the slave.

1. Press **[Menu]** to enter the system menu setting interface.
2. Select **[PARALLEL SETUP]** to enter the parallel setting interface.
3. Press the Up and Down key to select the “Operating Mode” > “Parallel”.
4. Set “Phase Class” as “Single”.
5. Set “Phase/Position” of each unit as “Slave-B(2)” and “Slave-C(3)”.

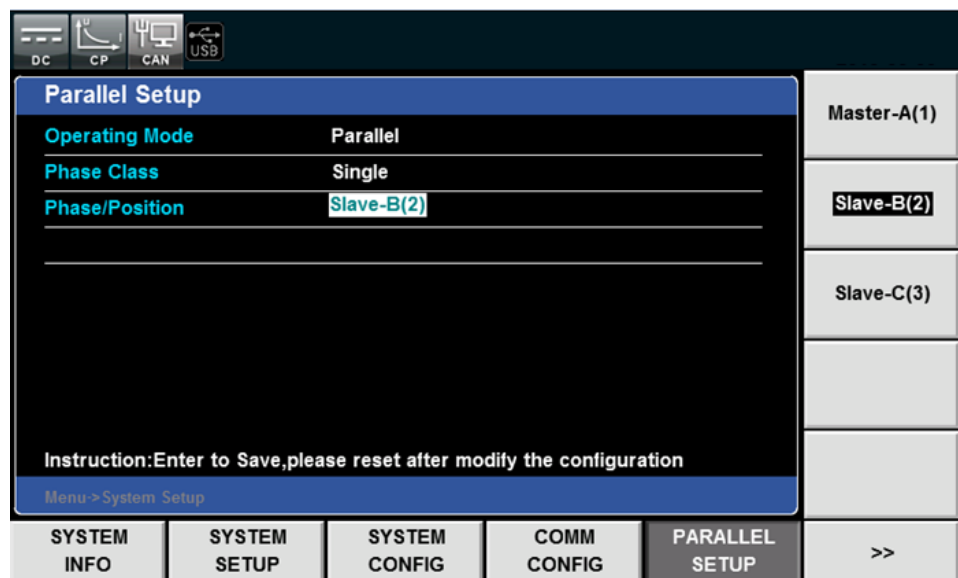

6. Press **[Enter]** to save the setting.

Select one electronic load as the master.

1. Press **[Menu]** to enter the system menu setting interface.
2. Select **[PARALLEL SETUP]** to enter the parallel setting interface.
3. Press the Up and Down key to select the “Operating Mode” > “Parallel”.
4. Set “Phase Class” as “Single”.

5. Set "Phase/Position" as "Master-A(1)".
6. Set "Total Unit" as 3.

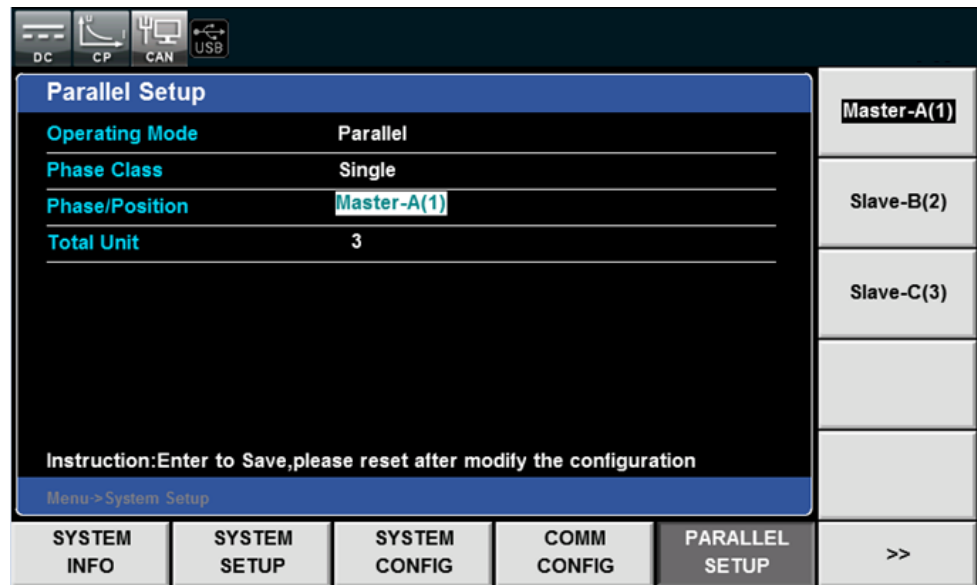

7. Press [Enter] to save the setting.

After saving the settings, the user must power off three electronic loads and power on again. The interfaces of master and slave are shown as below.

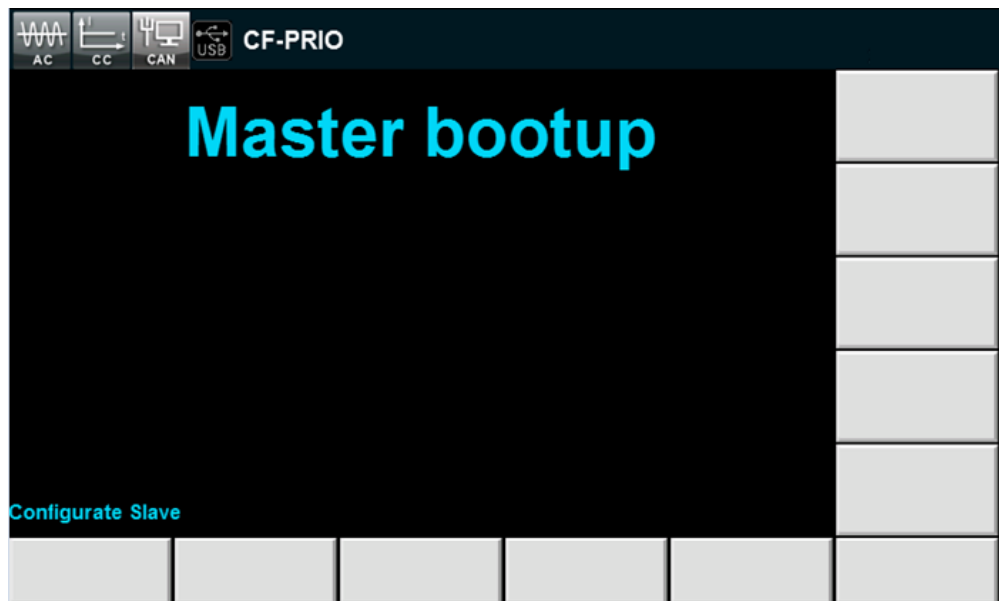



3.18 Three-phase Function

IT8600 can be used to test three-phase AC power supplies. The AC load can be operated in the CC/CR/CP mode. In three-phase applications, the user can select Y-type and Δ -type connection according to actual requirements. The flexible connection meets various test requirements.

Take the example of IT8615 electronic load, the schematic diagram of three-phase connection is as follows. When you connect system bus, the Terminating Resistor is a must for the first load unit and the last load unit.

- Y-type connection

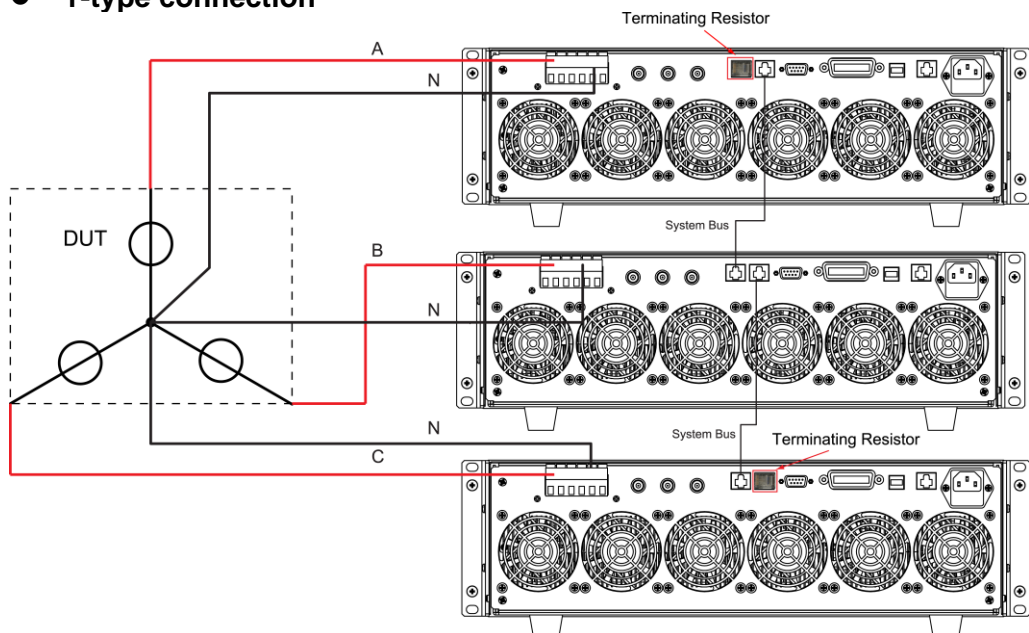

- **Δ-type connection**

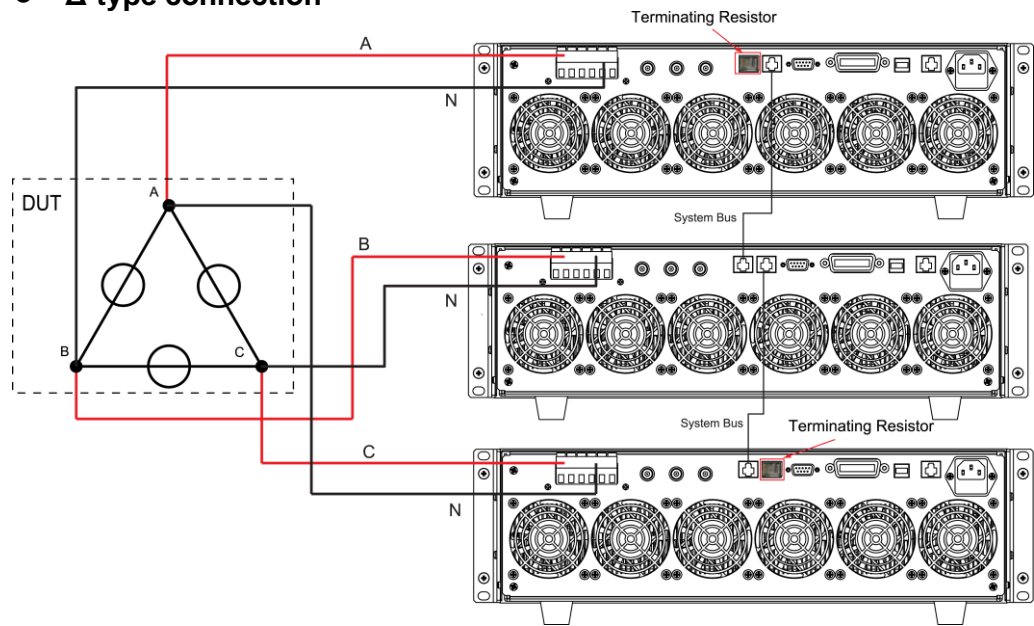

The IT862X series System Bus ports are different from the IT861X series. When connecting the 3 phase communication cables between IT862X cabinets, connect the EXT_BUS according to the following diagram.

When you connect system bus, the Terminating Resistor is a must for the first load unit and the last load unit.

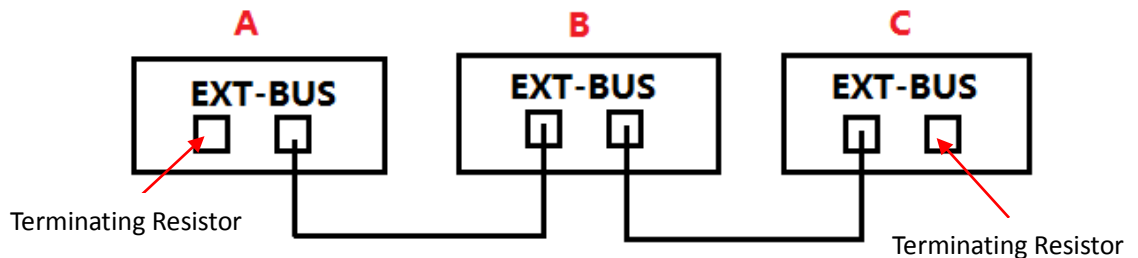

Configure the internal relationship of instruments after connecting the system bus.

The configuration interface of IT8620 series and IT8615/IT8615L are not the same. The specific setting steps are as follows.

- Take the example of IT8615 electronic load

During the three-phase setting, firstly, the user must set three electronic loads to be one master and two slaves. Then the user can configure the phase of three electronic loads in master.

Select two electronic loads as the slaves.

1. Press **[Menu]** to enter the system menu setting interface.
2. Select **[PARALLEL SETUP]** to enter the parallel setting interface.
3. Press the Up and Down key to select the "Operating Mode" > "Parallel".
4. Set "Master/Slave" as Slave, as shown below:



5. Press **[Enter]** to save the setting.

Select one electronic load as the master.

1. Press **[Menu]** to enter the system menu setting interface.
2. Select **[PARALLEL SETUP]** to enter the parallel setting interface.
3. Press the Up and Down key to select the “Operating Mode” > “Parallel”.
4. Press the Up and Down key to select the “Single/Three Phase” > “Single”.
5. Set “Master/Slave” as Master.
6. Set “Total Slave Unit” as 2, as shown below:

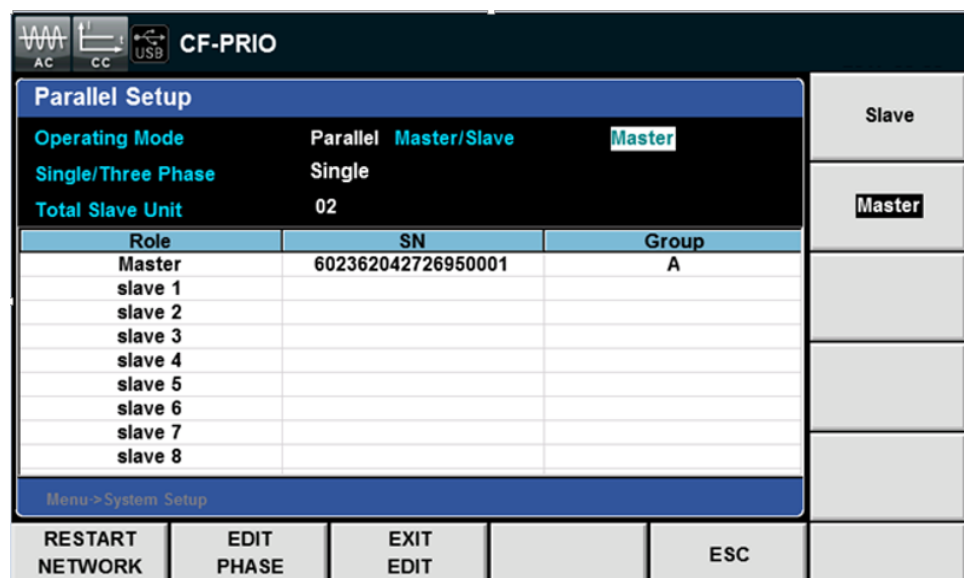

7. Press **[Enter]** to save the setting.

After saving the settings, the user must power off the three electronic loads and power on again.

Then the user can configure the Phase A/B/C of three electronic loads on

master.

1. Press **[Menu]** to enter the system menu setting interface.
2. Select **[PARALLEL SETUP]** to enter the parallel setting interface.
3. Press the Up and Down key to select the “Single/Three Phase” > “A+B+C”.
4. Press **[EDIT PHASE]**, configure the Phase A/B/C of three electronic loads, as shown below.

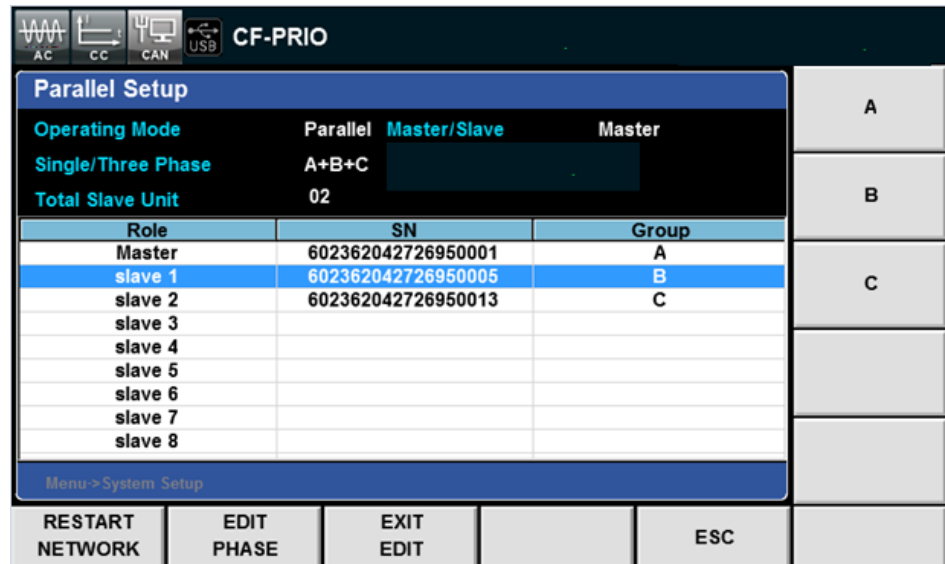

5. Press **[Enter]** to save the setting.

After saving the settings, the user must power off the master and power on again. The interface of master is shown as below.



- Take the example of IT8628 electronic load

Select two electronic loads as the slaves.

1. Press **[Menu]** to enter the system menu setting interface.
2. Select **[PARALLEL SETUP]** to enter the parallel setting interface.
3. Press the Up and Down key to select the “Operating Mode” > “Parallel”.

4. Set "Phase Class" as "A+B+C".
5. Set "Phase/Position" of each unit as "Slave-B(2)" and "Slave-C(3)".

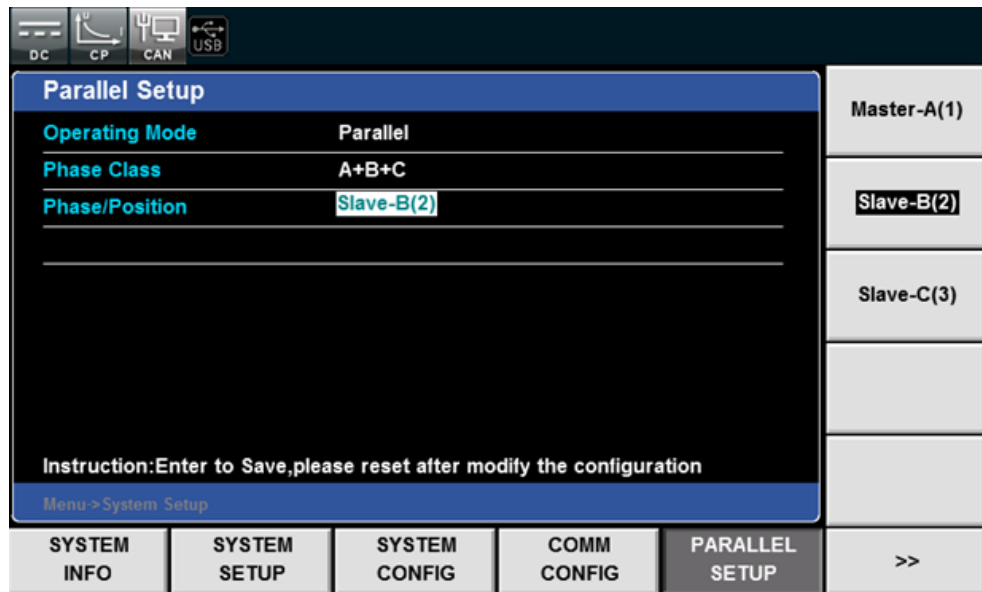

6. Press **[Enter]** to save the setting.

Select one electronic load as the master.

1. Press **[Menu]** to enter the system menu setting interface.
2. Select **[PARALLEL SETUP]** to enter the parallel setting interface.
3. Press the Up and Down key to select the "Operating Mode" > "Parallel".
4. Set "Phase Class" as "A+B+C".
5. Set "Phase/Position" as "Master-A(1)".
6. Set "Total Unit" as 3.

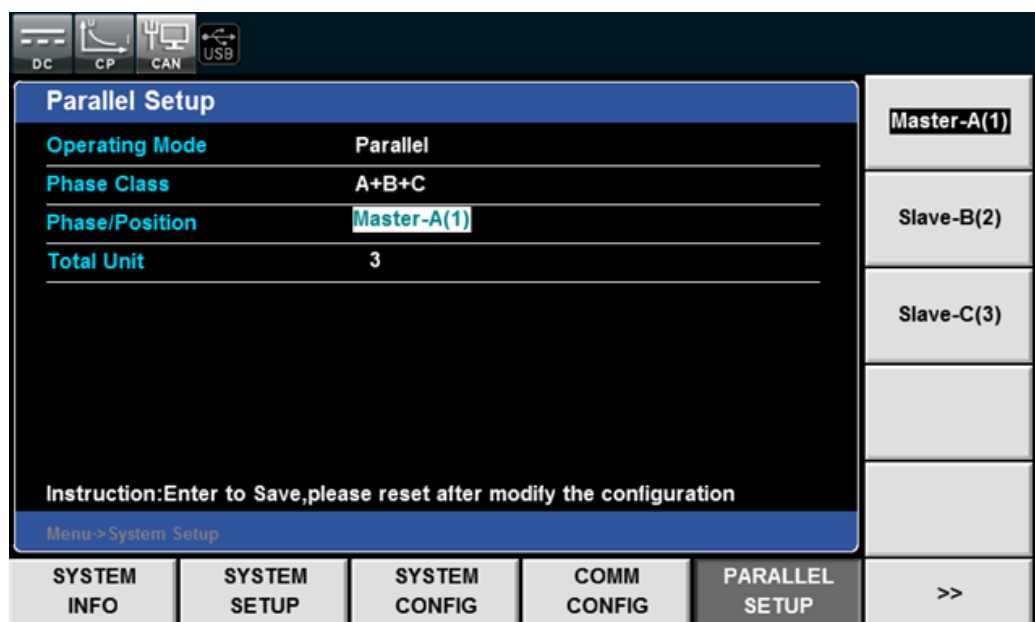

7. Press **[Enter]** to save the setting.

After saving the settings, the user must power off three units and power on again. The interface of master is shown as below.



3.19 Three-phase Parallel Function

IT8600 can be used in parallel connection of multiple units of the same models to test three-phase AC power supplies. The AC load can be operated in the CC/CR/CP mode. In three-phase parallel applications, the user can select Y-type and Δ -type connection according to actual requirements. The flexible connection meets various test requirements.

Connections of three-phase parallel power supplies include Y-type and Δ -type connection, as shown in the following figures. When you connect system bus, the Terminating Resistor is a must for the first load unit and the last load unit.

- Y-type connection

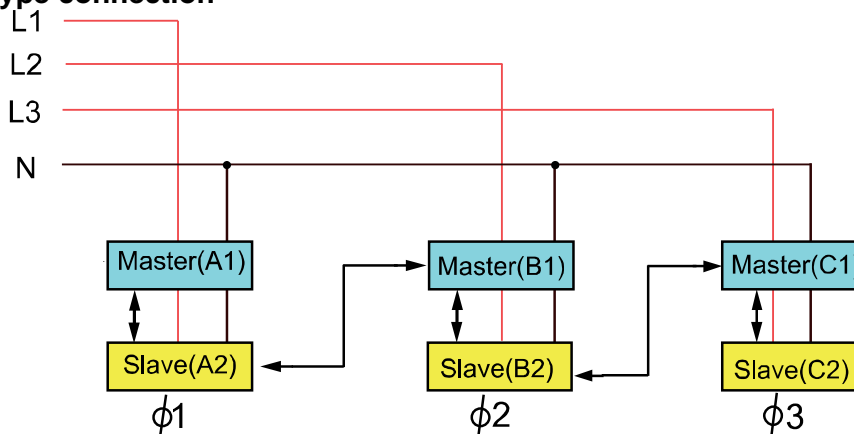

- Δ -type connection

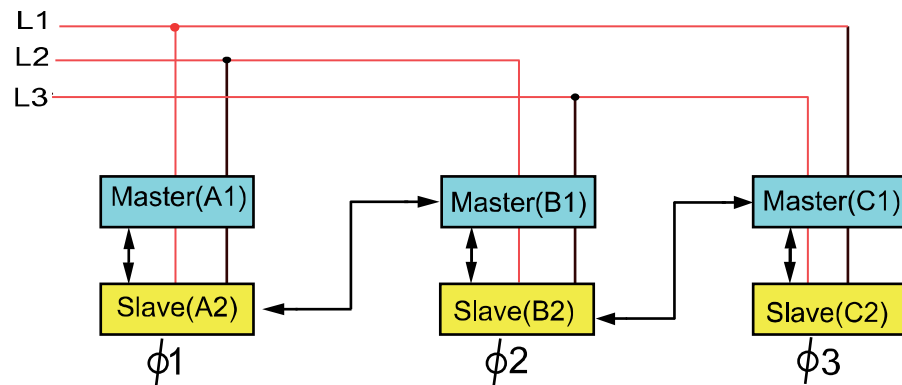

The system bus interface can be connected to multiple units via cross-over cables, as shown in the above connection of diagram of three-phase parallel power supplies.

During the three-phase parallel setting, the user can make six or nine electronic loads to be connected. Take the example of six, firstly, the user must set six electronic loads to be one master and five slaves. Then the user can configure the phase of six electronic loads in master. Specific setting steps are as follows.

Select five electronic loads as the slaves.

1. Press **[Menu]** to enter the system menu setting interface.
2. Select **[PARALLEL SETUP]** to enter the parallel setting interface.
3. Press the Up and Down key to select the “Operating Mode” > “Parallel”.
4. Set “Master/Slave” as Slave, as shown below:

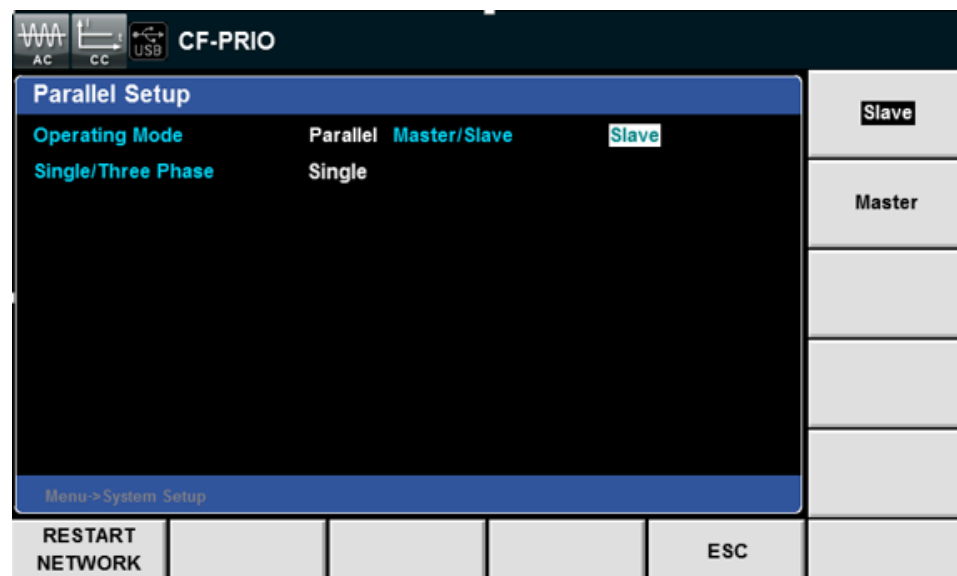

5. Press **[Enter]** to save the setting.

Select one electronic load as the master.

1. Press **[Menu]** to enter the system menu setting interface.
2. Select **[PARALLEL SETUP]** to enter the parallel setting interface.
3. Press the Up and Down key to select the “Operating Mode” > “Parallel”.
4. Press the Up and Down key to select the “Single/Three Phase” > “Single”.
5. Set “Master/Slave” as Master.

6. Set “Total Slave Unit” as 5, as shown below:

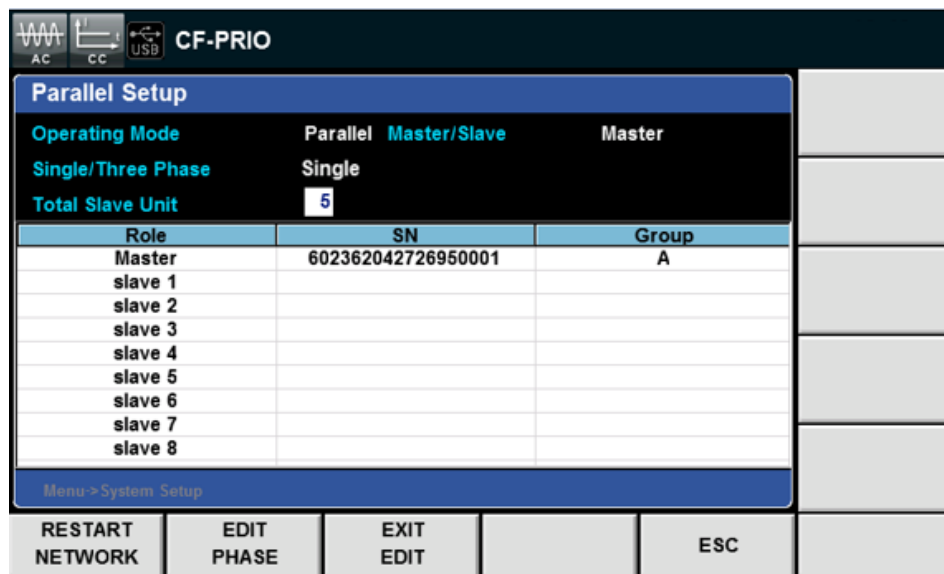

7. After saving the settings, the user must power off the six electronic loads and power on again.

Configure the Phase A/A/B/B/C/C of the six electronic loads on master.

1. Press **[Menu]** to enter the system menu setting interface.
2. Select **[PARALLEL SETUP]** to enter the parallel setting interface.
3. Press the Up and Down key to select the “Single/Three Phase” > “A+B+C”.
4. Press **[EDIT PHASE]**, configure the Phase A/A/B/B/C/C of the six electronic loads.
5. Press **[Enter]** to save the setting.
6. After saving the settings, the user must power off the master and power on again.

3.20 Three-phase setup

You can set different power or current in three-phase mode. Press **[Enter]** to save the parameter of three-phase, then press **[Set]** to enter into the configure interface, as shown as below.



Description of parameter setting:

Parameter	Description
Balance	<ul style="list-style-type: none"> ● NO: Unbalance mode. You can set different values of each phase. ● YES: Balance mode. You can set value of each phase consistently.
Set Sel	Select A/B/C/ABC phase. You can set ABC phase only in balance mode.
View Sel	Select the phase A/B/C to display.

Chapter4 Load Functions

This chapter describes the AC load simulation function and DC load simulation function in details. IT8600 electronic load supports the AC load function and DC load function. The user can set system parameters to select the AC load function or DC load function.

IT8600 electronic load has two working modes, i.e. AC and DC, and multiple operating modes, i.e. CC, CR, CP, CV (DC).

The CF and PF of current can be set in the CC and CP mode under the AC mode to truly simulate the actual current.

4.1 Load Function Introduction

IT8600 AC/DC electronic load supports the function of AC load and DC load. The user can set system parameters and select the AC load function or DC load function. Load functions are shown in the following figure.

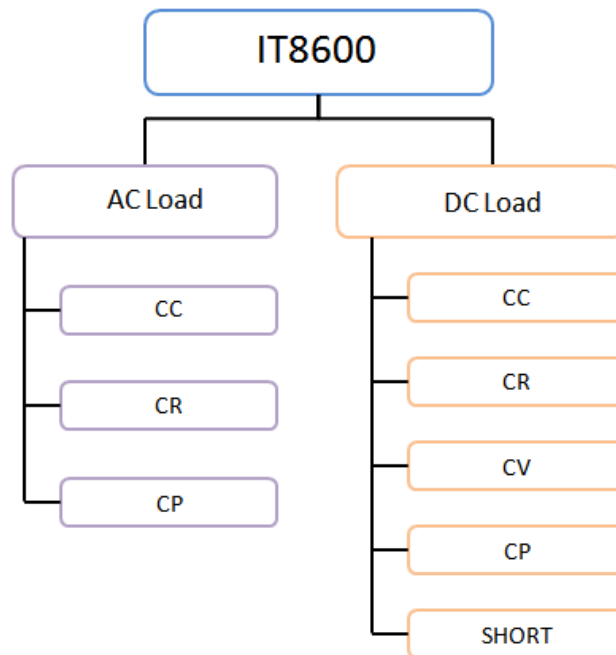

4.2 AC Load Function

The AC load function can be simulated by IT8600 electronic load according to the settings. The user can select the present load function in the system menu. When “Mode Select” is set as AC, the electronic load is in the AC load mode. The default mode of IT8600 electronic load is the AC load mode.

In the AC load mode, the load can work in the following steady-state operating modes:

- Constant current mode (CC);
- Constant resistance mode (CR);
- Constant power mode (CP).

4.2.1 CF and PF Setting

The operating modes of the AC load mode include the constant current mode,

constant resistance mode and constant power mode. In the constant current and constant power operating mode, the user can program the power factor (PF) or crest factor (CF). In the constant resistance operating mode, the PF is constantly 1.

The user can set the CF, PF and their priority by pressing “Menu” > “SYSTEM SETUP”.

- When the “CF/PF setting” item is set as CF, only CF can be programmed in the AC load mode.
- When the “CF/PF setting” item is set as PF, only PF can be programmed in the AC load mode.
- When the “CF/PF setting” item is set as “BOTH”, set the CF and PF priority and select the prevailing parameter.

Crest factor (CF): the crest factor is the ratio of the waveform crest value to the effective value. When CF is set as 1.414, a sinusoidal current waveform will be created under DSP.

Power factor (PF): the power factor is the ratio of the active power to apparent power.

When the CF/PF setting is “BOTH”, set the CF and PF priority. The setting range of CF and PF is affected by the priority. When priority is given to CF, the setting range of PF is affected by the present CF value. When priority is given to PF, the setting range of CF is affected by the PF setting.

The relationship of CF and PF is as below diagram. If setting CF and PF values are out of the available range, the load will still choose the allowable CF and PF that are close to the available range.

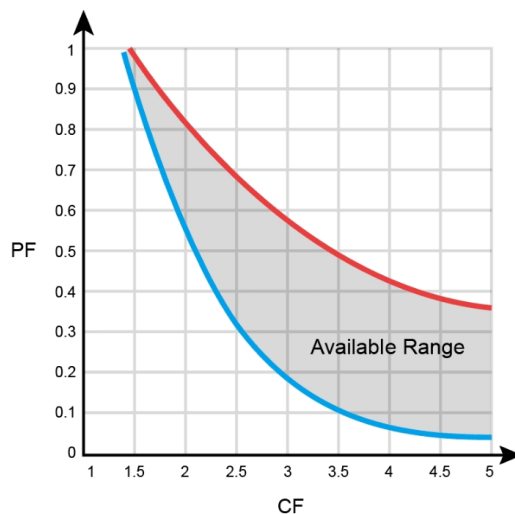

We provide the maximum and minimum values of PF when set CF priority. Refer to the table below.

Testing condition: CF/PF Setting: BOTH CF/PF Priority: CF

Maximum and Minimum values of PF in Different CF					
CF	PFmax	PFmin (50Vrms)	PFmin (100Vrms)	PFmin (200Vrms)	PFmin (300Vrms)
1.5	0.993	0.988	0.983	0.98	0.982
1.75	0.935	0.855	0.852	0.847	0.842
2	0.849	0.679	0.648	0.673	0.622
2.25	0.78	0.533	0.532	0.531	0.529
2.5	0.703	0.422	0.392	0.376	0.375
2.75	0.658	0.309	0.312	0.313	0.315
3	0.593	0.229	0.232	0.235	0.237
3.25	0.557	0.203	0.207	0.21	0.212
3.5	0.511	0.151	0.154	0.158	0.162
3.75	0.485	0.125	0.129	0.133	0.137
4	0.463	0.105	0.109	0.113	0.117
4.25	0.437	0.09	0.093	0.097	0.102
4.5	0.399	0.077	0.08	0.085	0.089
4.75	0.393	0.067	0.07	0.074	0.077
5	0.36	0.058	0.061	0.066	0.071

- Users set CF priority:

Example1: When the output voltage of UUT is 100Vrms, set CF=3 and PF=0.1. The load will follow the closest PF value which is 0.232(PF min).

Example2: When output voltage of UUT is 200Vrms, set CF=4 and PF=0.6. The load will follow the closest PF value which is 0.463(PF max).

- Users set PF priority:

Example1: When set PF priority, if users set PF=0.6 and CF=3, the available CF range is from 1.85 to 2.83. Then the load will follow the closest CF value which is about 2.83.

Example2: When set PF priority, if users set PF=0.4 and CF=2, the available CF range is from 2.30 to 4.25. Then the load will follow the closest CF value which is about 2.30.

4.2.2 Constant Current Mode (CC)

In CC mode, the load will sink a constant current according to the programmed value if the input voltage is higher than the minimum operating voltage. Press [Set] on the front panel and soft key CC to enter the CC mode setting interface.

The current waveform is synchronized with the sinusoidal waveform of the voltage on the right side of the coordinate axis. The PF value can be set within ± 1 . According to the definition of IT8600 electronic load, when the PF setting is positive, the current is ahead of voltage; otherwise, the current lags behind voltage.

In the CC mode, press the Up and Down key and select the parameter to be set, including the Iset, CF and PF value. The CF mode, PF mode and "Both" mode can be set for CF/PF.

In the case of loading, the current setting and voltage input should meet the input requirements; otherwise, the undervoltage protection of the electronic load will be enabled, and loading will fail. For details of undervoltage protection, refer to 3.12 Protection Function.

The voltage-current relation is shown below:

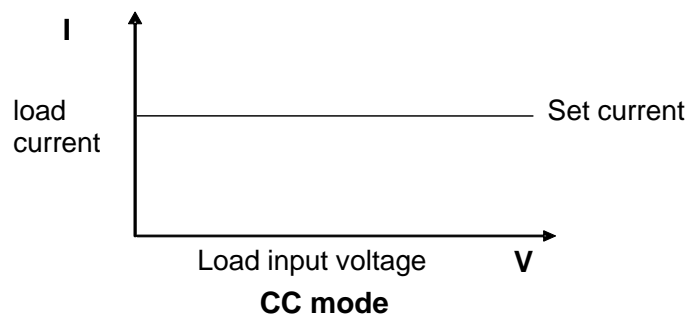

Fig. 3-1 Voltage-current Relation in CC Mode

BOTH Mode

- Mode setting

The initial default mode of IT8600 electronic load is the “BOTH” mode. This mode can be set as follows:

1. Press [**Menu**] to enter the system setting interface.
2. Press the soft key corresponding to [**SYSTEM SETUP**] to enter the system parameter setting interface.
3. Press the Up and Down key and select the “CF/PF Setting”. Press the soft key corresponding to [**BOTH**] on the right side, and set the present CF/PF parameter “BOTH” Mode.

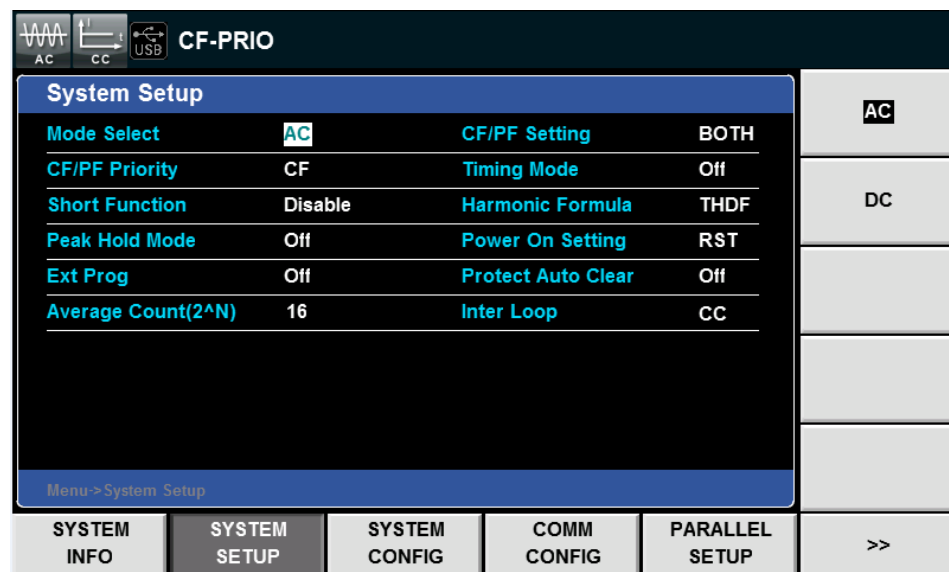

After selecting “BOTH”, set the CF and PF priority.

4. Press the Up and Down key and select the “CF/PF Priority”. Press the soft key corresponding to [**CF**] or [**PF**] on the right side, and set the CF and PF priority.
5. Press [**Esc**] to exit or [**Home**] to go back to the main interface of CC mode.

- CC parameter setting

The user can press the Up and Down key in the main interface of CC Mode to select the parameter to be set, including CF, PF and Iset. The user can also rotate the knob to set the current value or press numeric keys to input the set value. Follow the CF and PF relation during setting. For details, refer to 4.2.1 “CF and PF setting”.

1. Press **[Set]** to enter the parameter setting interface of CC Mode.
2. Press the Up and Down key to select the parameter to be set.
3. Directly set the present value through the knob or press numeric keys to input the value. In case of wrong input by numeric keys, press  to delete the present input.



- Iset=1.00A: constant current of CC Mode.
 - CF=1.414: crest factor.
 - PF=1.000: power factor.
4. Press **[Enter]** to confirm.
 5. Press **[On]** to enable load input. Loading will be started and the current will sink.

CF Mode

- Mode setting

The initial default mode of IT8600 electronic load is the “BOTH” mode. CF Mode can be set as follows:

1. Press **[Menu]** to enter the system setting interface.
2. Press the soft key corresponding to **[SYSTEM SETUP]** to enter the system parameter setting interface.
3. Press the Up and Down key and select the “CF/PF Setting”. Press the soft key corresponding to **[CF]** on the right side, and set the present CF/PF parameter as “CF” mode.
4. Press **[Esc]** to exit or **[Home]** to go back to the main interface of CC Mode. “CF-ONLY” will appear on the main interface.

- CC parameter setting

The user can press the Up and Down key in the main interface of CC Mode to select the parameter to be set, including CF and Iset. The user can also rotate the knob to set the current value or press numeric keys to input the set value. The CF range is 1.414 to 5.000.

1. Press **[Set]** to enter the parameter setting interface of CC Mode.

2. Press the Up and Down key to select the parameter to be set.
3. Directly set the present value through the knob or press numeric keys to input the value. In case of wrong input by numeric keys, press  to delete the present input.

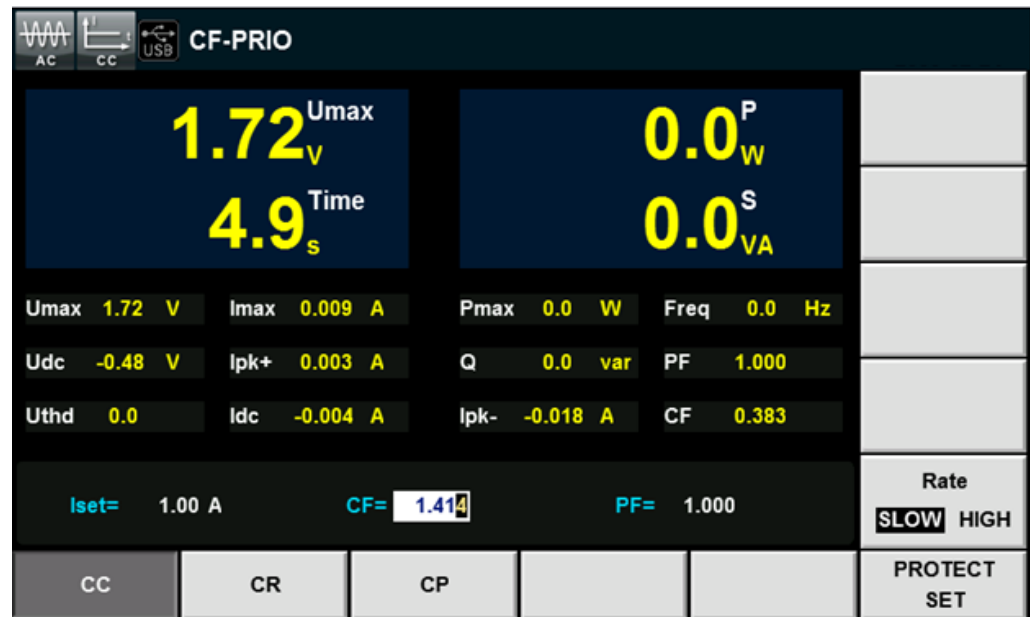

- Iset=1.00A: constant current of CC Mode.
 - CF=1.414: crest factor, 1.414 to 5.000.
 - PF=1.000: power factor. It cannot be edited.
4. Press **[Enter]** to confirm.
 5. Press **[On]** to enable load input. Loading will be started and the current will sink.

PF Mode

- Mode setting

The initial default mode of IT8600 electronic load is the “BOTH” mode. PF Mode can be set as follows:

1. Press **[Menu]** to enter the system setting interface.
2. Press the soft key corresponding to **[SYSTEM SETUP]** to enter the system parameter setting interface.
3. Press the Up and Down key and select the “CF/PF Setting”. Press the soft key corresponding to **[PF]** on the right side, and set the present CF/PF parameter as “PF” mode. The figure shows the “BOTH” setting interface.
4. Press **[Esc]** to exit or **[Home]** to go back to the main interface of CC Mode. “PF-ONLY” will appear on the main interface.

- CC parameter setting

The user can press the Up and Down key in the main interface of CC Mode to select the parameter to be set, including PF and Iset. The user can also rotate the knob to set the current value or press numeric keys to input the set value. The PF range is -1.000 to 1.000.

1. Press **[Set]** to enter the parameter setting interface of CC Mode.

2. Press the Up and Down key to select the parameter to be set.
3. Directly set the present value through the knob or press numeric keys to input the value. In case of wrong input by numeric keys, press  to delete the present input.

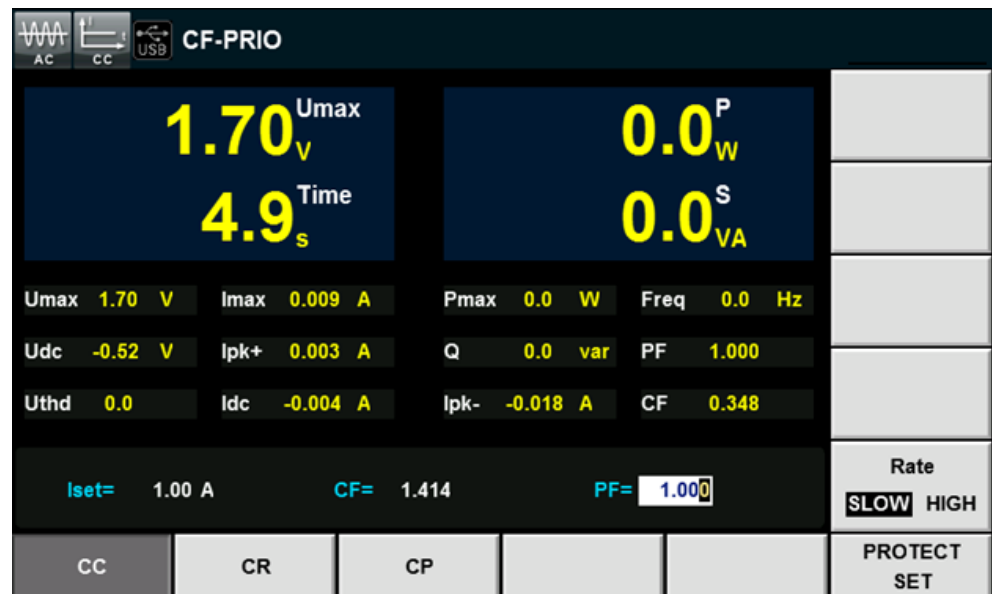

- I_{set}=1.00A: constant current of CC Mode.
 - CF=1.414: crest factor. It cannot be edited.
 - PF=1.000: power factor, -1.000 to 1.000.
4. Press **[Enter]** to confirm.
 5. Press **[On]** to enable load input. Loading will be started and the current will sink.

4.2.3 Constant Resistance Mode (CR)

In the constant resistance mode, the AC electronic load is equivalent to the constant resistance and will suck the current of linear ratio to the input voltage, the current waveform is the same as the input voltage waveform, and PF is constantly 1, as shown below.

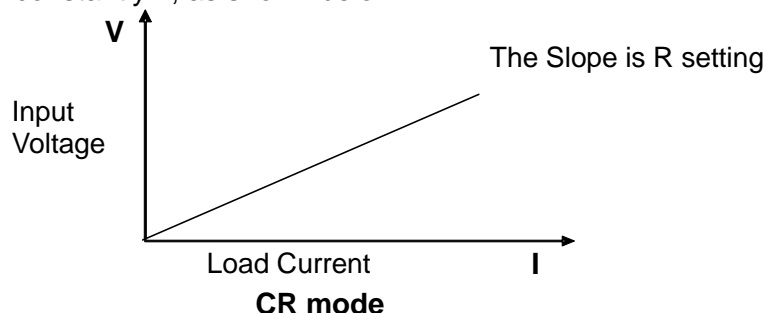

Fig. 3-2 Voltage-current Relation in CR Mode

In CR Mode, the resistance can be modified in two methods:

- Rotate the knob to set the constant resistance.
- Use numeric keys to input the resistance value and press **[Enter]** to confirm the set resistance.

Operating steps

1. Press **[Set]** and **[CR]** to enter the parameter setting interface of CR Mode.
Rset=2500Ω
The resistance, input voltage and load's sink current should meet the requirements of $R=U/I$.
2. Set the working resistance value and press **[Enter]** to confirm it.

4.2.4 Constant Power Mode (CP)

In the constant power mode, the constant power is required for the electronic load, and the current sinks according to the set power, as shown below. If the input voltage increases, the input current will decrease to keep the power $P (=V * I)$ at the set value.

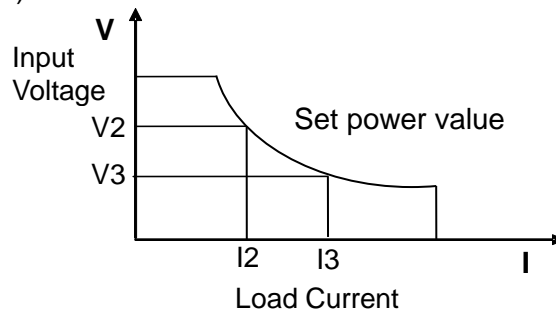

Fig. 3-3 Voltage-current Relation of CP Mode

The set current waveform is synchronized with the sinusoidal waveform of the voltage on the right side of the coordinate axis. PF can be set within ± 1 . Similar to CC Mode, the user can set the PF and CF value in CP Mode. The user can also select the CF Mode, PF Mode and BOTH Mode. The loading parameter CF, PF and Pset can be set in the main interface of CP Mode.

BOTH Mode

- Mode setting

The initial default mode of IT8600 electronic load is the "BOTH" mode. This mode can be set in the same method as in CC Mode. Refer to 4.2.2 "Constant Current Mode (CC)".

- CP parameter setting

The user can press the Up and Down key in the main interface of CP Mode to select the parameter to be set, including CF, PF and Pset. The user can also rotate the knob to set the current value or press numeric keys to input the set value. Follow the CF and PF relation during setting. For details, refer to 4.2.1 "CF and PF setting".

1. Press **[Set]** to enter the parameter setting interface of CC Mode.
2. Press the soft key corresponding to CP to enter the CP mode setting interface.
3. Press the Up and Down key to select the parameter to be set.
4. Directly set the present value through the knob or press numeric keys to input the value. In case of wrong input by numeric keys, press  to delete the present input.



- Pset=50.0W: constant power of CP Mode.
 - CF=1.414: crest factor.
 - PF=1.000: power factor.
5. Press **[Enter]** to confirm.
 6. Press **[On]** to enable load input. Loading will be started and the current will sink.

CF Mode

- Mode setting

The initial default mode of IT8600 electronic load is the “BOTH” mode. CF Mode can be set in the same method as in CC Mode. Refer to 4.2.2 “Constant Current Mode”.

- CP parameter setting

The user can press the Up and Down key in the main interface of CP Mode to select the parameter to be set, including CF and Pset. The user can also rotate the knob to set the current value or press numeric keys to input the set value. The CF range is 1.414 to 5.000.

1. Press **[Set]** to enter the parameter setting interface of CC Mode.
2. Press the soft key corresponding to CP to enter the CP mode setting interface.
3. Press the Up and Down key to select the parameter to be set.
4. Directly set the present value through the knob or press numeric keys to input the value. In case of wrong input by numeric keys, press  to delete the present input.



- Pset=50.0W: constant power of CP Mode.
 - CF=1.414: crest factor, 1.414 to 5.000.
 - PF=1.000: power factor. It cannot be edited.
5. Press **[Enter]** to confirm.
 6. Press **[On]** to enable load input. Loading will be started and the current will sink.

PF Mode

- Mode setting

The initial default mode of IT8600 electronic load is the “BOTH” mode. PF Mode can be set in the same method as in CC Mode. Refer to 4.2.2 “Constant Current Mode”.

- CP parameter setting

The user can press the Up and Down key in the main interface of CP Mode to select the parameter to be set, including PF and Pset. The user can also rotate the knob to set the current value or press numeric keys to input the set value. The PF range is -1.000 to 1.000.

1. Press **[Set]** to enter the parameter setting interface of CC Mode.
2. Press the soft key corresponding to CP to enter the CP mode setting interface.
3. Press the Up and Down key to select the parameter to be set.
4. Directly set the present value through the knob or press numeric keys to input the value. In case of wrong input by numeric keys, press  to delete the present input.



- $P_{set}=50.0W$: constant power of CP Mode.
 - $CF=1.414$: crest factor. It cannot be edited.
 - $PF=1.000$: power factor, -1.000 to 1.000.
5. Press **[Enter]** to confirm.
 6. Press **[On]** to enable load input. Loading will be started and the current will sink.

4.3 DC Load Function

IT8600 electronic load can simulate the DC electronic load function according to the setting. The user can select the present load function in the system menu. When "Mode Select" is set as "DC", the present load function of the electronic load is in the DC mode.

IT8600 electronic load can be operated in the following four modes:

- Constant current mode (CC)
- Constant voltage mode (CV) (Only for IT8615/IT8615L)
- Constant register mode (CR)
- Constant power mode (CP)

4.3.1 Constant Current Mode (CC)

In this mode, the electronic load will sink a constant current in accordance with the programmed value regardless of the input voltage. See figure 3-4.

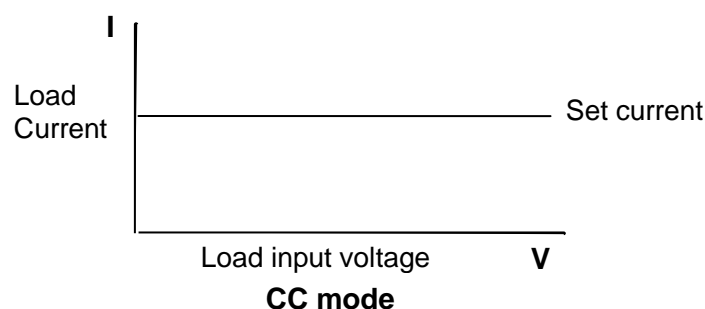

Figure 3-4 CC mode

4.3.2 Constant Resistance Mode (CR)

In this mode, the electronic load was equivalent to a constant resistance, as shown below, the electronic load will linearly change the current according to the input voltage. See figure 3-5.

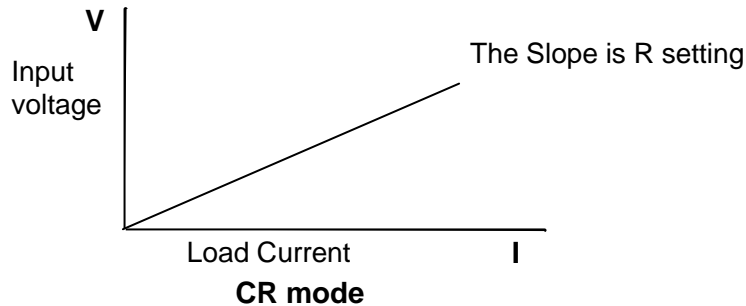

Figure 3-5 CR mode

4.3.3 Constant Voltage Mode (CV) (Only for IT8615/IT8615L)

In this mode, the electronic load will attempt to sink enough current to control the source voltage to the programmed value. See figure 3-6.

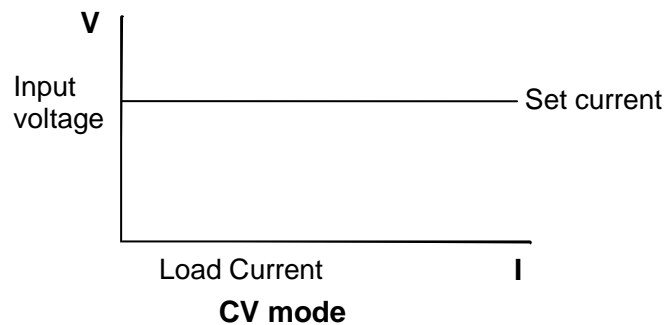

Figure 3-6 CV mode

4.3.4 Constant Power Mode (CP)

In CP mode, the load will consume a constant power. See Figure 3-7. If the input voltage rises, the input current will decline. The $P (=V * I)$ will remain on the set power.

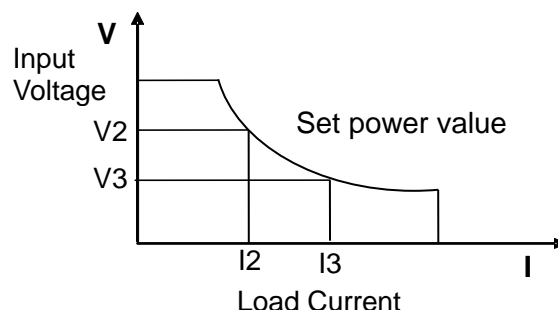

Figure 3-7 CP mode

4.3.5 Short Circuit Simulation Function

The electronic load can simulate a short circuit at the input end in the DC load

mode. You can press **[Short]** to switch over the short circuit status. Short circuit operations have no influence on the present setting. When the OFF status is enabled, the load will return to the original setting.

The actual current of the load in the short circuit status depends on the current working mode and current range. In CC, CP and CR Mode, the maximum short circuit current is 120% of the current range. In CV Mode, the short circuit means that the constant voltage of the load is 0V.

Enabling the short circuit function:

1. In the main interface of the DC load function, press **[SHORT]** to enter the short circuit simulation mode.
2. Press the soft key **[SHORT FUN]** on the right side. Press the set value once to switch DIS and ENA. DIS means the short circuit function is disabled, and ENA means the short circuit function is enabled. You can also perform setting in the system menu.
 - a) Press **[Menu]** to enter the system setting interface.
 - b) Press the soft key corresponding to **[SYSTEM SETUP]** to enter the system parameter setting interface.
 - c) Press the Up and Down key and select "Short Function". Press the soft key corresponding to **[On]** on the right side to enable the short circuit simulation function.
3. Press **[START]** and **[STOP]** to start and stop short circuit simulation.

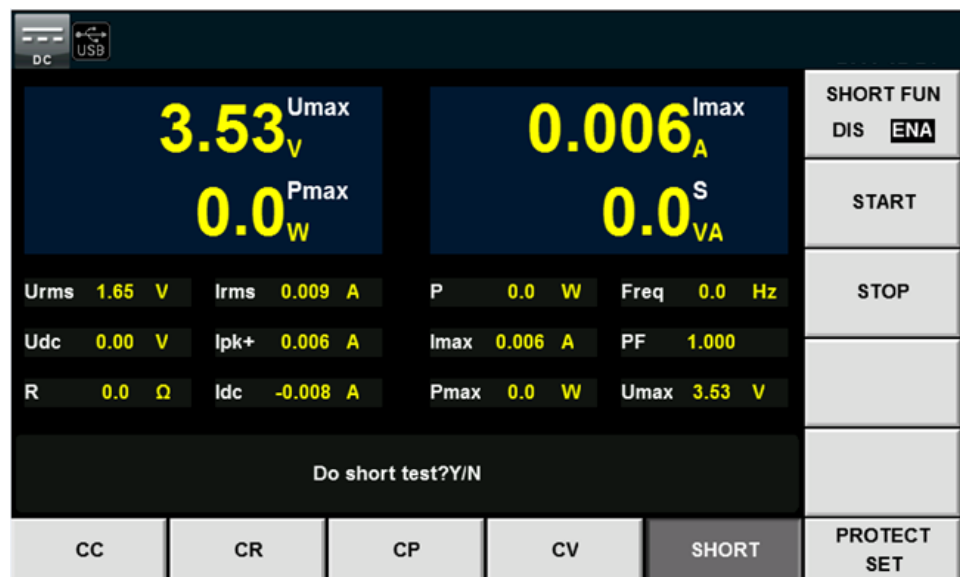

Chapter5 Measurement Functions

This chapter describes the characteristics and operations of the basic metering function of IT8600 electronic load.

IT8600 electronic load has rich functions of basic metering of electric energy and can accurately measure the parameters such as V_{rms} , V_{pk} , V_{dc} , I_{rms} , I_{pk} , I_{dc} , W , VA , VAR , CF , PF and $Freq$.

5.1 Interface Introduction



Soft Key of Menu	Description
Peak Hold	Peak Holding Mode On: to enable the peak holding mode. Measurement data are updated if peak data are sampled. Off: to disable the peak holding mode.
CONFIG	Configuration of basic metering.

5.2 Parameter Measurement

The measured value displayed in large letters on the upper part of the interface can be modified according to the user requirements. Press **[CONFIG]** to enter the metering parameter configuration interface. Press the soft key corresponding to the metering parameter.



Description of the metering parameters:

Parameter	Description	Parameter	Description
Idc	Average current	Irms	Current effective value [VA]
Imax	Maximum current	Ipk+	Positive current peak value [A]
Ipk-	Negative current peak value [A]	Udc	Average voltage [V]
Urms	Voltage effective value [VA]	Umax	Maximum voltage
P	Active power [W]	S	Apparent power [VA]
Q	Reactive power [var]	Pmax	Maximum power
R	Resistance	Freq	Frequency
CF	Crest factor	PF	Power factor
Uthd	Voltage total harmonic distortion	Time	When Timing mode is enabled, the timer starts to count time after the load state is ON. When Timing Mode is Off, Time has been 0.

5.2.1 AC Mode

In AC Mode, you can apply load and measure the current input parameter of the power supply based on CC, CR and CP Mode.

CC Mode

Press **[Set]** to enter the default CC Mode. Set the current value and start loading in CC Mode. The metering interface and parameters are shown in the following figure.

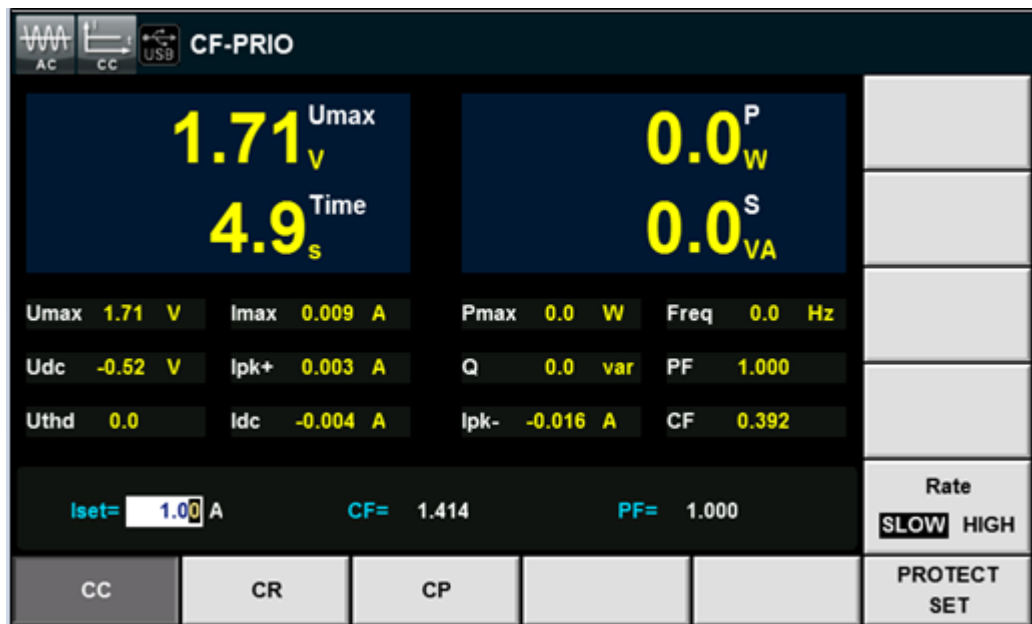

CR Mode

Press **[Set]** and **[CR]** to enter CR Mode. Set the resistance value and start loading in CR Mode. The metering interface and parameters are shown in the following figure.

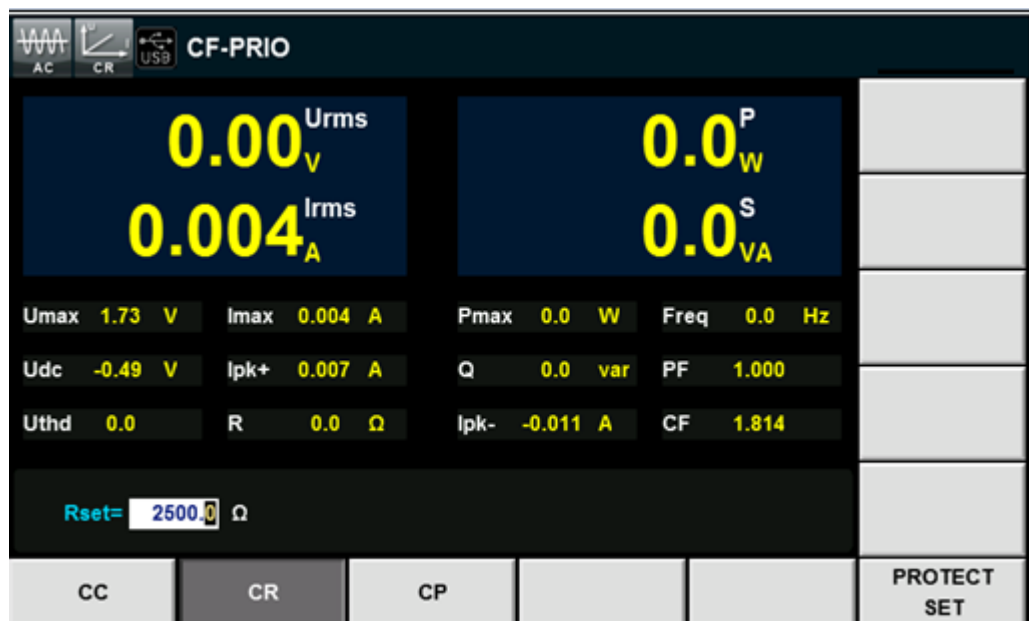

CP Mode

Press **[Set]** and **[CP]** to enter CP Mode. Set the resistance value and start loading in CP Mode. The metering interface and parameters are shown in the following figure.



5.2.2 DC Mode

In DC Mode, you can apply load and measure the current input parameter of the power supply in CC, CV, CR and CP Mode.

CC Mode

Press **[Set]** to enter the default CC Mode. Set the current value and start loading in CC Mode. The metering interface and parameters are shown in the following figure.



CR Mode

Press **[Set]** to enter the default CR Mode. Set the resistance and start loading in CR Mode. The metering interface and parameters are shown in the following figure.



CP Mode

Press **[Set]** to enter the default CP Mode. Set the resistance and start loading in CP Mode. The metering interface and parameters are shown in the following figure.



CV Mode (Only for IT8615/IT8615L)

Press **[Set]** to enter the default CV Mode. Set the resistance and start loading in CV Mode. The metering interface and parameters are shown in the following figure.



Chapter6 Waveform Display Function

IT8600 electronic load has the oscilloscope function. This chapter describes the oscilloscope function and operations of the electronic load.

6.1 Interface Introduction

IT8600 electronic load has the function of displaying the waveform based on sampling data. The user can select to display or hide the voltage and current waveform of the input unit. Only the necessary waveform is displayed, which can facilitate observation. The waveform display interface includes the vertical axis and horizontal axis.

Introduction to soft keys of interface

Press **[Scope]** and the following waveform display interface will appear.

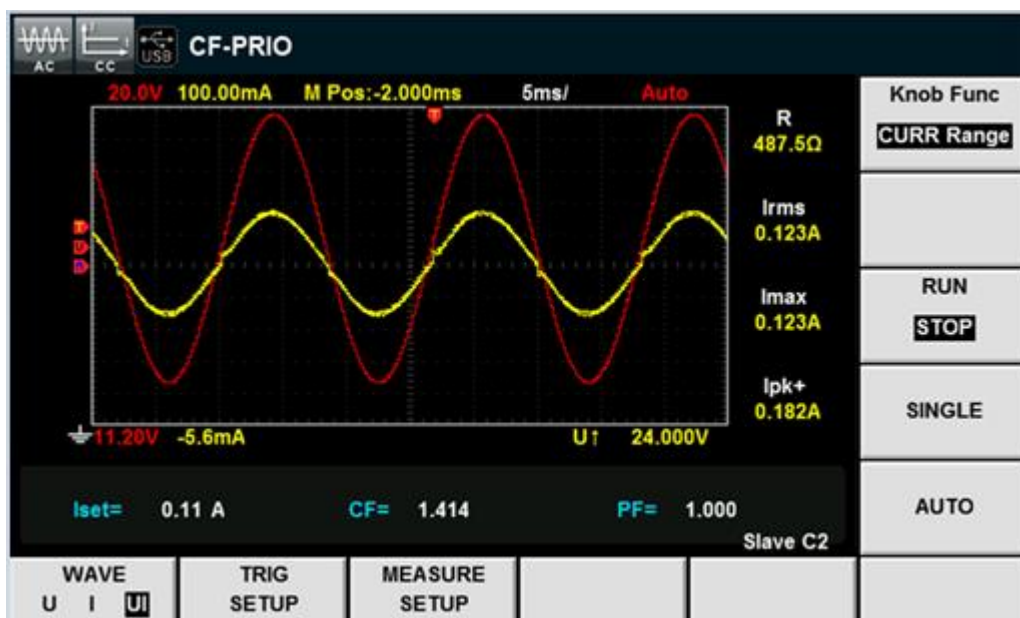

Description of keys on the waveform display interface:

Parameter Name	Description
Knob Func	Knob selection: the following variables can be adjusted by rotating the knob: <ul style="list-style-type: none"> ● Volt Range ● CURR Range ● Volt Base ● Curr Base ● Trig Level ● Trig Delay ● Time/div
RUN/STOP	Run/stop: press the corresponding soft key to run or stop the waveform status.

Parameter Name	Description
SINGLE	Single measurement key: when single measurement is enabled in the Stop status, the stop status is enabled again after one measurement based on the current data updating rate. When single measurement is enabled in the Run status, the instrument immediately restarts one measurement and then enters the Stop status.
WAVE(U/A/UA)	Used for selecting the waveform to be displayed on the screen: voltage, current and voltage/current.
AUTO	Automatic adjustment key: when the corresponding soft key is pressed, the input signal of the power meter will be calibrated automatically to display the best effects of input signals.
TRIG SETUP	Trigger setting.
MEASURE SETUP	Measurement setting

Introduction to waveform display interface

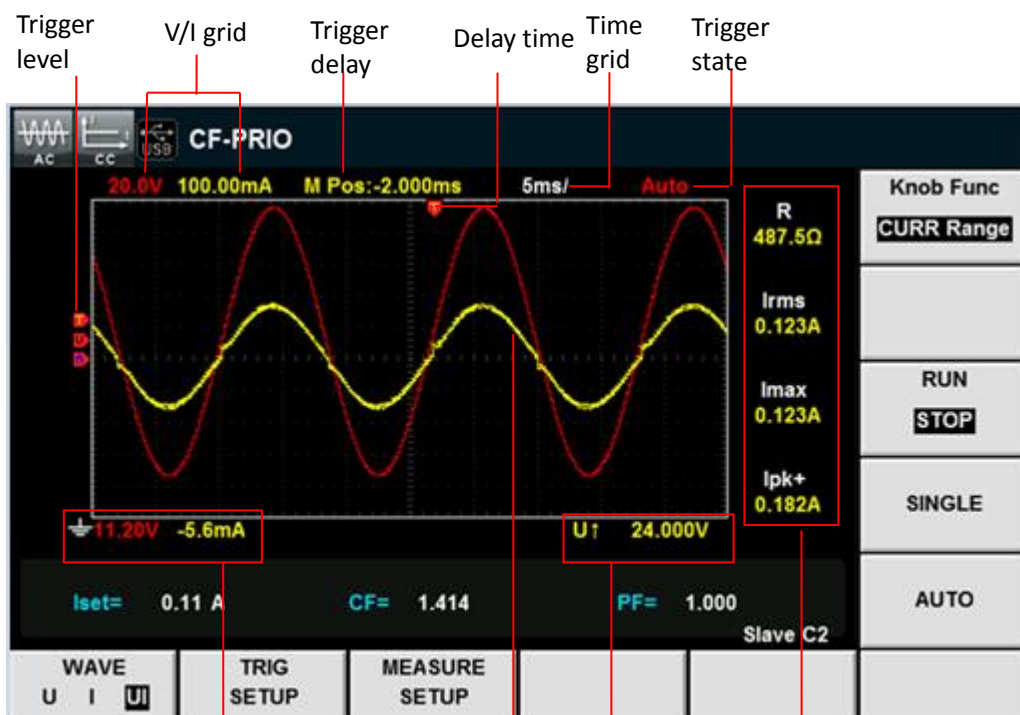

The voltage/current difference between ground level and point of center vertical

wave Trigger level

Measuring parameters

Description of the trigger state:

Trigger State	Description
Auto	The selected trigger mode is "Auto". After triggering, the trigger state "Auto" appears.
Auto?	The selected trigger mode is "Auto". The trigger state is "Auto?" if triggering is not performed.

Trigger State	Description
Trig	The selected trigger mode is “Normal”. After triggering, the trigger state “Trig” appears.
Trig?	The selected trigger mode is “Normal”. The trigger state is “Trig?” if triggering is not performed.
Stop	Press the soft key [Stop] in the waveform display interface. The trigger state “Stop” appears.

Vertical calibration

The voltage range and current range are subject to vertical calibration (voltage/scale and current/scale). Press the soft key **[Knob Func]** and select Volt Range or CURR Range. Rotate the knob to set the voltage or current range of each interval.

Horizontal calibration

If the soft key **[Knob Func]** is pressed and “Time/div” is selected, you can rotate the knob to adjust the horizontal scale (scanning speed). When the horizontal (time/scale) setting is changed by rotating the knob, you can observe the change of time/scale on the screen. During data collection, the sampling speed can be changed by adjusting the horizontal calibration knob. After collection is stopped, the collected data can be amplified by adjusting the horizontal calibration knob.

Trigger delay

If the soft key **[Knob Func]** is pressed and “Trig Delay” is selected, you can rotate the knob to adjust the trigger delay. In this case, if the knob is rotated, the trigger point will move horizontally and the delay time will be displayed on the screen. To change the delay time, move the trigger point  horizontally and set the distance between the trigger point and the horizontal center. The trigger point moves along the top end of the display grid.

Trigger waveform

When the specified trigger conditions are satisfied, the trigger waveform will be displayed. The triggering time is the trigger point, generally on the right of the screen. When the trigger point is reached, the screen will display the waveform from left to right over time. The user should set the following parameters before using the trigger function.

- Trigger mode

The trigger mode refers to the condition to update the contents on the screen. It is divided into the Auto mode and Normal mode. In the Auto mode, the displayed waveform will be updated when triggering occurs in the suspension time; otherwise, the displayed waveform will be updated automatically.

In the Normal mode, the displayed waveform will be updated in the case of triggering and not updated in the case of no triggering.

- Trigger source

The trigger source is used for generating trigger conditions. The user can select the trigger source in the input signal of the input unit.

- Trigger slope

The slope refers to the change of the signal from low level to high level (rising edge) or from high level to low level (falling edge). The slope used as a trigger condition is referred to as the trigger slope.

- Trigger level

The trigger level refers to the level which the trigger slope passes through. If the signal of the trigger source passes through the set trigger level according to the specified trigger slope, triggering occurs. When the soft key **[Knob Func]** is pressed and “Trig Level” is selected, you can rotate the knob to adjust the trigger level. In this case, the trigger level can be changed by rotating the knob and you can observe trigger level changes on the screen.

6.2 Adjustment of Measurement Parameters

You can rotate the knob to adjust the vertical calibration, horizontal calibration, trigger delay and trigger level on the waveform display interface. Detailed steps are as follows.

Operating steps

1. Press **[Scope]** to enter the waveform display interface.
2. In the waveform display interface, press the soft key **[Knob Func]** to select the parameter to be adjusted.
3. Rotate the knob to adjust the parameter. Corresponding value changes will be displayed in the interface.

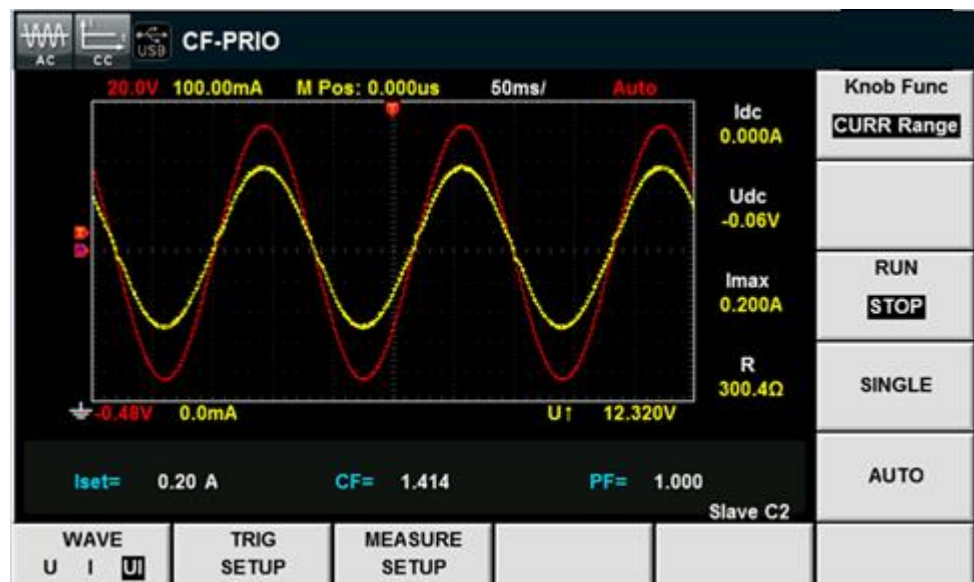

6.3 Setting of Trigger Configuration

To enable the trigger function, you should select the trigger source, trigger mode, trigger slope, etc. Detailed steps are as follows.

Operating steps

1. Press [**Scope**] to enter the waveform display interface.
2. In the waveform display interface, press the soft key corresponding to **[TIRG SETUP]** to enter the trigger setting interface, as shown below.

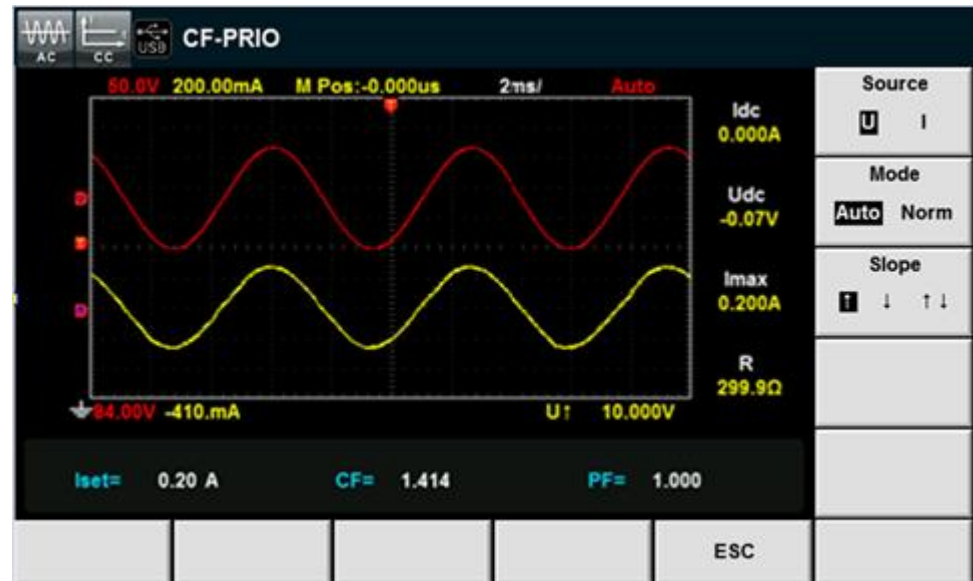

3. Press the soft key corresponding to the parameter on the right side and select the required trigger configuration. Refer to the Trigger Waveform for details.
 - ◆ Source (trigger source): select the voltage or current as the trigger source.
 - ◆ Mode (trigger mode): select the Auto or Normal mode.
 - ◆ Slope (trigger slope): select the rising edge, falling edge or rising/falling.

Chapter7 Harmonic Measurement Function

This chapter describes the characteristics and operations of the voltage harmonic measurement function of IT8600 electronic load.

7.1 Overview

The bandwidth of IT8600 electronic load is 100kHz. The voltage harmonic measurement of high speed and wide dynamic scope can be realized. In the harmonic mode, the active power, reactive power, phase and voltage harmonic distortion factor (UTHD) of voltage harmonics can be tested. In addition, IT8600 can be used for measuring multiple harmonics. At most 50 harmonics of fundamental frequency can be measured.

IT8600 electronic load can display harmonic parameters in the list or bar chart form to make the analysis of test result clear.

Introduction to soft keys of interface

Select [**Harmonic**] and the following initial interface of harmonic measurement will appear.

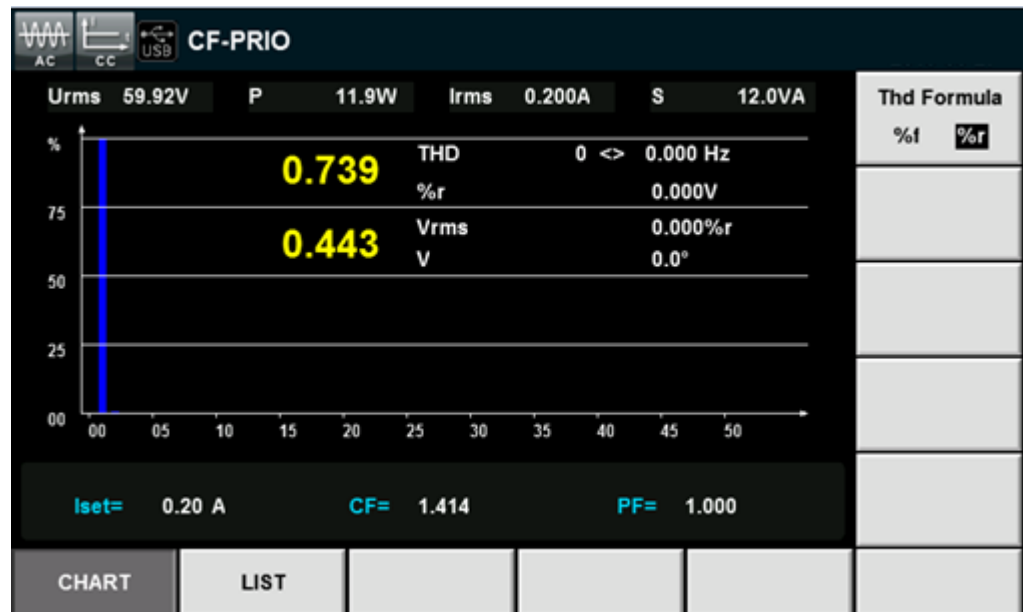

Description of the harmonic measurement interface:

Parameter Name	Parameter Description
Thd Formula	Distortion factor calculation formula. % r: displaying harmonics in the form of percentage to the overall voltage amplitude of all harmonics. % f: displaying harmonics in the form of percentage to the fundamental voltage.
CHART	Bar chart form.
LIST	List form.

Introduction to harmonic information

- Harmonic bar chart screen

When “CHART” is selected in the harmonic measurement screen, the bar chart of harmonic measurement results will be displayed. The bar chart is used to show the percentage of each harmonic measurement. Harmonics can be displayed in full sequence, odd sequence and even sequence by options. The bar chart shown below is harmonics in full sequence.

Percentage of harmonic

Parameter of harmonic

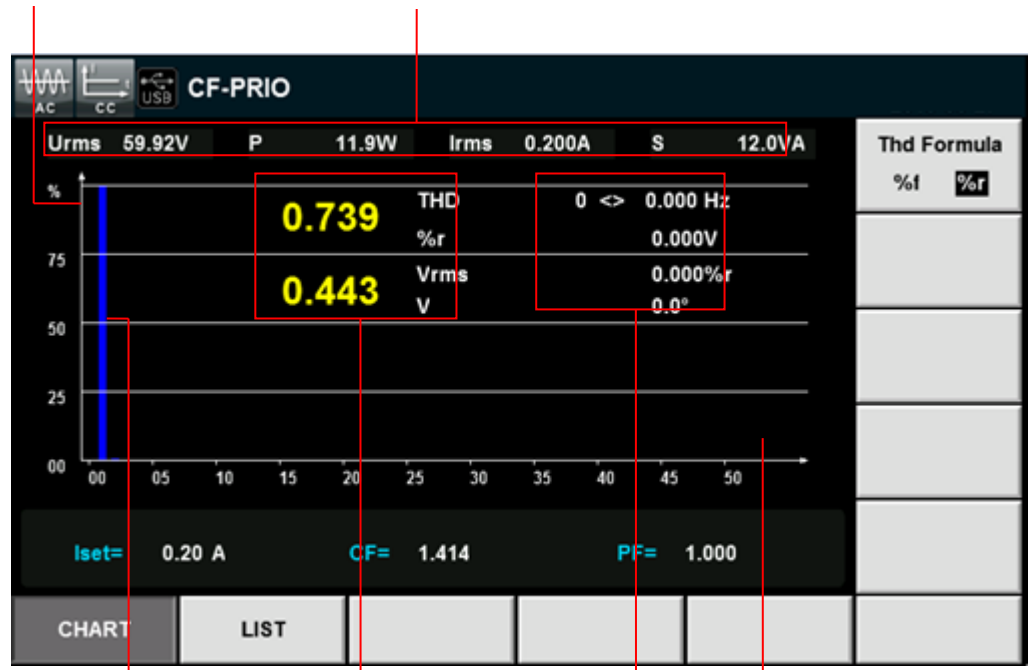

Histogram

THD value

Parameter of X-axis: harmonic each harmonic numbers

Technical terms of explanation:

THD value: the total harmonic parameters include the total harmonic distortion factor (THD) and total harmonic content.

Parameters of single harmonic measurement include the frequency, harmonic content, harmonic distortion factor and phase of each harmonic. The user can rotate the knob to select each harmonic to be displayed. The selected harmonic will be displayed in red in the bar chart.

- Harmonic list

When “LIST” is selected in the harmonic measurement mode, the list of harmonic measurement results will be displayed, including the voltage, phase and voltage harmonic distortion factor (UTHD) of each harmonic.

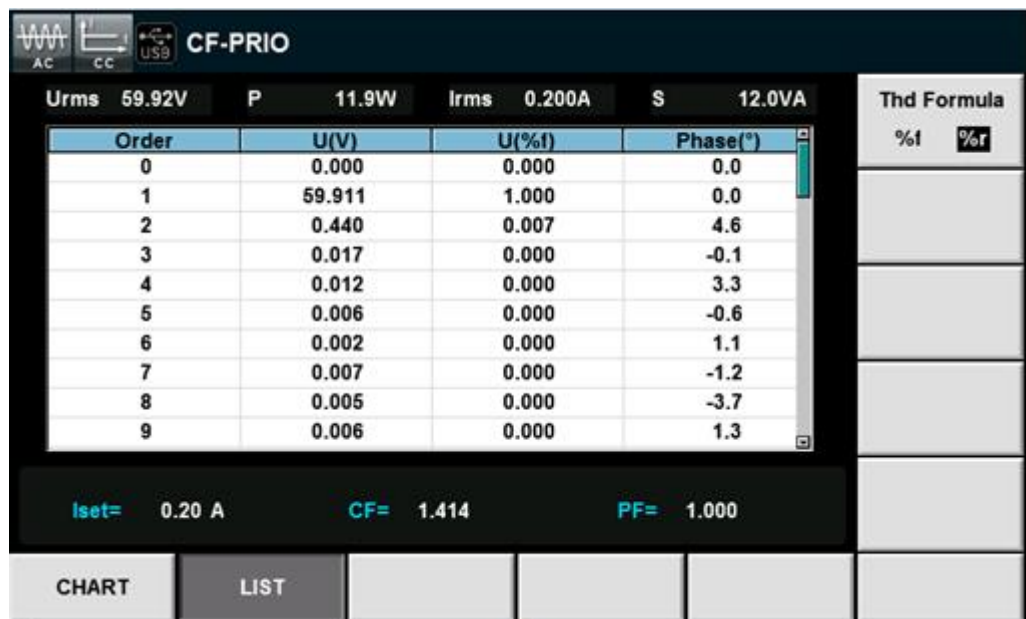

Harmonic content: this list includes all harmonic parameters of each harmonic, including voltage, harmonic distortion factor of voltage and phase. Measurement parameters are defined as follows:

Abbreviation	Description	Abbreviation	Description
U (V)	Voltage	φ_{UI} (°)	Phase difference of k^{th} order harmonic voltage and harmonic current
U (%f)	Harmonic distortion factor of voltage	UThd	-
Phase (°)	Phase	-	-

Harmonic number list: the signal data of 0-50 harmonic(s) will be shown in the LIST. You can press the Up and Down key to display the hidden rows, i.e. hidden data of each harmonic. In this case, when the row scrolling bar is operated, the current page is displayed in the high-brightness green bar.

7.2 Setting of Harmonic Measurement Configuration

Distortion factor calculation formula:

The following two formulas can be selected for calculation of the distortion factor.

- %r: using all harmonic measurement data from the minimum harmonic order (0^{th}) to the maximum harmonic order (within the upper limit of analysis orders) as the denominator.
- %f: using the data of fundamental wave (1-order) components as the denominator.

The distortion factor calculation formulas and methods of different measurement functions are as follows:

Measurement function	Calculation formula and method	
	%r	%f
Harmonic distortion factor of voltage	$\frac{U(k)}{U(Total)}$	$\frac{U(k)}{U(1)}$
Harmonic distortion factor of active power	$\frac{P(k)}{P(Total)}$	$\frac{P(k)}{P(1)}$
Total harmonic distortion rate of voltage	$\frac{\sqrt{\sum_{k=2}^{\max} U(k)^2}}{U(Total)}$	$\frac{\sqrt{\sum_{k=2}^{\max} U(k)^2}}{U(1)}$
Total harmonic distortion rate of active power	$\frac{\sum_{k=2}^{\max} P(k)}{P(Total)}$	$\frac{\sum_{k=2}^{\max} P(k)}{P(1)}$

NOTE

Total harmonics are calculated as follows: $U(Total) = \sqrt{\sum_{k=0}^{\max} U(k)^2}$, $I(Total) = \sqrt{\sum_{k=0}^{\max} I(k)^2}$,

$P(Total) = \sum_{k=0}^{\max} P(k)$. k indicates the harmonic order, and max indicates the upper limit of

analysis orders. max is determined by the frequency of PLL source automatically, 50 orders at most.

Chapter8 Routine Maintenance

This chapter describes the general maintenance items and methods for IT8600 AC/DC load.

8.1 Error Information Reference

IT8600 AC/DC load can provide detailed error and prompt information to help the user easily locate problems and implement measurement during measurement and operation.

This section introduces all error information, causes and troubleshooting of IT8600 AC/DC load, and lists all prompt information.

Prompt information list

Prompt Information
Voltage range has reach the lowest limit
Current range has reach the lowest limit
Voltage base has reached the highest limit
Current base has reached the highest limit
Voltage trig level has reached the highest limit
Current trig level has reached the highest limit
Trig delay has reached the lowest limit
Time base has reach the lowest limit
Voltage range has reached the highest limit
Current range has reached the highest limit
Voltage base has reach the lowest limit
Current base has reached the lowest limit
Voltage trig level has reached the lowest limit
Current trig level has reached the lowest limit
Trig delay has reached the highest limit
Time base has reached the highest limit
Time set ok
Local has been locked
Remote state
Key has been locked
Protect clear
not used in current state!
Save4 is performed
Save3 is performed
Save2 is performed
Save1 is performed
Recall4 is performed
Recall3 is performed
Recall2 is performed
Recall1 is performed
Save screen ok
Log stop
Log start

Error information list

Error Information	Error Interpretation	Cause
Time set fail!	The time setting fails.	Invalid time setting.
Dsp is abnormal	DSP is abnormal.	Low power voltage or other causes.
Save screen fail	Screen copying fails.	The USB file system is not applicable to the instrument.
usb is not detected	No USB is detected.	USB is not readable or the USB interface is damaged.
Save error	Saving fails.	The setting is invalid or EEPROM is damaged.
Recall error	Recalling fails.	No information can be recalled.

8.2 Routine Maintenance

This section introduces the basic maintenance involved in routine operation of the instrument, such as cleaning, self-repair, etc.

Cleaning

Wipe the machine with dry or slightly wet cloth. Do not wipe the inside of the machine without permission. Cut off the power supply before cleaning.

Initialization

Factory settings of the system will be restored by implementing this operation:

1. Select **[Menu]** to enter the system menu interface.
2. Press **[>>]** to display the system menu in the scrolling form.
3. Press the soft key corresponding to **[SYSTEM INITIAL]** to enter the system initialization interface, as shown below.



4. Press the Up and Down key and select the menu item (blue background) to

be initialized. “✓” behind the menu item indicates that this item will be initialized, while “✗” indicates that this item will not be initialized.

5. Press the soft key corresponding to the symbol on the right side of the interface and select whether to initialize this menu item, or press the soft key **[All/✓]** (all menu items will be initialized) or **[All/✗]** (all menu items will not be initialized) at the bottom.
6. Press the soft key **[START]** and the system will be initialized. Press **[ESC]** to exit.

8.3 Contact ITECH Engineer

This section introduces the procedures for troubleshooting.

Preparations before contact

In case of instrument failure, make the following preparations before returning the instrument to ITECH for repair or contacting the engineer.

1. Complete all inspections specified in “Self-check of Instrument Fault” and check whether the fault still occurs.
2. If the fault still occurs, carefully read the warranty service and restriction requirements in the foreword of the manual and confirm that your instrument meets the warranty service requirements.
3. To send the instrument back to the manufacturer for repair, see the requirements in “Return for Repair”.

Self-check of Instrument Fault

In case of instrument failure, please perform the following self-checks. If the instrument can be recovered by simple check, the cost and time can be saved. Before contacting the engineer of ITECH, please check the following items.

- Check whether the instrument is powered on.
- Check whether the instrument is started up normally.
- Check whether the fuse is in good condition.
- Check whether other connectors are in good condition, including cables, plugs, etc.
- Check whether the system configuration is correct in operation.
- Check whether the self-test is successfully and whether all specifications and performance meet the specified requirements.
- Check whether the instrument displays error information.
- Use other instruments instead of this instrument for confirmation.

SN collection

ITECH will improve the product performance, availability and reliability from time to time. The service personnel of ITECH will record the changes of each instrument, and all the relevant information will be identified according to the SN. The SN will be used as the tracking ID of the instrument returned for repair.

To contact the engineer, the valid SN will be an effective guarantee for effective service and complete information. You can obtain the instrument SN in the following methods:

1. Press [**Menu**] to enter the system setting interface of the electronic load.
2. The system will enter into “**SYSTEM INFO**” by default.. If the system is displayed in other menus, press [**SYSTEM INFO**] to enter the “**SYSTEM INFO**” interface and view the product model, SN, software version, etc.

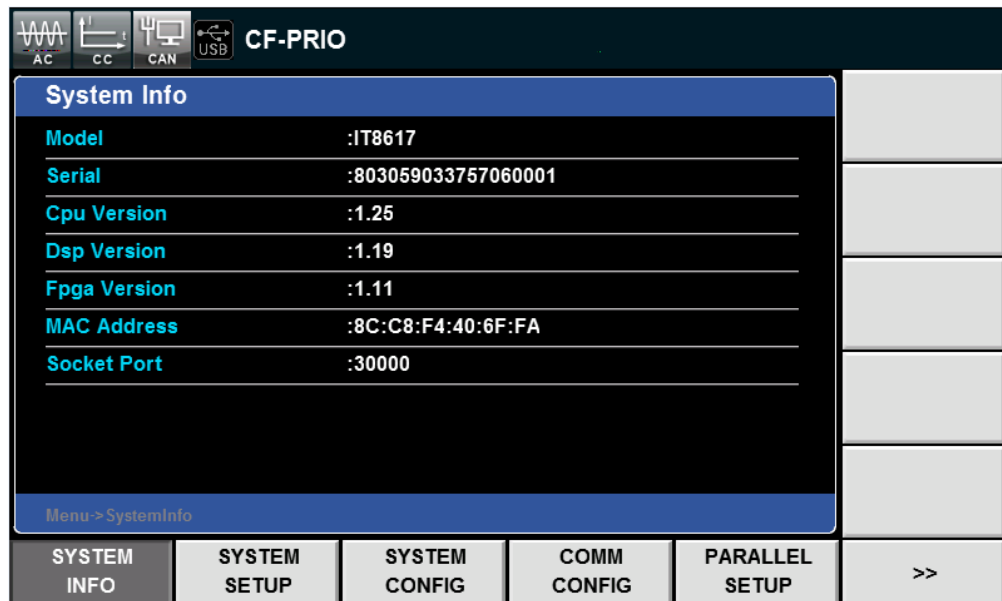

In this interface above, “Serial” is the instrument SN.

3. Record the SN.

Calibration interval

The calibration frequency recommended by ITECH for IT8600 AC/DC load is once a year.

8.4 Return for Repair

Before returning the instrument for repair, please read the following requirements.

Packaging

Refer to the following steps to package the instrument to be returned for repair. Pack the instrument to be repaired into the package used in delivery, including relevant accessories.

Provide the detailed problem description, such as copy of error information and any related problem information.

CAUTION

- The instrument may be damaged if the unspecified package is used for delivery. Use the special package for delivery, and pack the instrument according to the packaging standards of delivery.
- Do not use the styrene particle material of any shape as the package material, as the instrument cannot be well fixed in the package or prevented from shaking. In addition, the instrument may be damaged by static electricity

generated by styrene particles or penetration of styrene particles into holes of the rear panel.

Read the requirements of transportation costs of warranty services in the foreword before delivery.

Chapter9 Communication Interfaces

Three standard interfaces are equipped for IT8600: GPIB, USB and LAN. Users can choose any of the USB, GPIB and LAN to achieve the communication with PC.

9.1 USB Interface

Use cables with both USB ends to connect with IT8600 and PC. All electronic load functions are programmable over the USB.

The USB488 interface capabilities are described below:

- The interface is 488.2 USB488 interface.
- The interface accepts REN_CONTROL, GO_TO_LOCAL, and LOCAL_LOCKOUT requests.
- The interface accepts MsgID = TRIGGER USBTMC command message and forwards TRIGGER requests to the function layer.

The USB488 device functions are described below:

- The device understands all mandatory SCPI commands.
- The device is SR1 capable.
- The device is RL1 capable.
- The device is DT1 capable.

9.2 GPIB Interface(Only for IT8600G series)

First connect GPIB interface to GPIB card of PC with IEEE488 BUS. They must be sufficient contact and tighten the screws. Press **[Menu]** key to enter system menu, press **[COMM CONFIG]** to find Communication interface. Select GPIB, and then set the GPIB address. The address can be set from 0 to 30. Press **[Enter]** to confirm. The electronic load operates from a GPIB address set from the front panel. The GPIB address is stored in non-volatile memory.

9.3 LAN Interface

Press **[Menu]** on the front panel to access the menu. Select **[COMM CONFIG]** to enter communication configuration page. Select LAN by pressing up/down keys and then configure Gateway, IP, Mask and Socket Port in the LAN options. Use a cross network cable through LAN interface to connect PC.

Chapter10 Technical Specifications

10.1 Main Technical Specifications

Parameter		IT8615	V1.4
AC Section			
Input parameter	Input voltage	50-420Vrms , 600V peak	
	Current	0-20Arms ,60Apeak	
	Power	0-1800VA	
	Frequency	45-450Hz	
CC mode *1	Range	0.1-20Arms	
	Resolution	2mA	
	Accuracy	±(0.1%+0.2%FS)	
CR mode *2	Range	2Ω~2.5KΩ	
	Resolution	16bit	
	Accuracy	0.2% +0.01S	
CP mode	Range	1800W	
	Resolution	0.4W	
	Accuracy	0.5%+0.5%FS	
Crest Factor(CF) (in CP and CC mode)	Range	1.414-5.0	
	Resolution	0.005	
	Accuracy	(0.5% / Irms) + 1% FS	
Power Factor (PF)	Range	0-1 lead or lag	
	Resolution	0.001	
DC Section			
Input parameter	Input voltage	10V-600V	
	Input current	0.1A-20A	
	Input power	0-1800VA	
Operating Mode	CC, CV, CR and CP		
Short Circuit Simulation	The maximum power or current in CC mode		
Meter			
Current	Range	0-60A	

Parameter		IT8615	V1.4
*1	Resolution	1mA	
	Accuracy	0.1%+0.2%FS+0.1%*CF ² *KHZ	
Voltage *1	Range	0-600V	
	Resolution	10mV	
	Accuracy	0.1%+0.1%FS	
Meter (continue)			
Other Parameters	S(VA), Q(VAR), P(W), Ip+, Ip-, Freq, THDv, CF, PF, R, FFT		
Other			
Vmonitor	±600V/±10V(Isolation)		
Imonitor	±60A/±10V(Isolation)		
Protection	OCP: 21Arms,OVP: 430Vrms,OPP: 1900W,OTP: 85°C		
Interface	USB, LAN		
Dimension(WxHxD)	482.5 mm x 133mm x 600.6mm		
Weight	30KG		
AC Input	Voltage	100-240V AC	
	Frequency	47-63 Hz	
	Fuse	3.15A	
	Power	150VA	

*1. Typical parameter values in case of the 45-100HZ.

*2. The scope of read-back resistance is($1/(1/R+(1/R)*0.2\%+0.01)$, $1/(1/R-(1/R)*0.2\%-0.01)$
 Test condition: The voltage/current input is no less than 10% FS

*3. Operating temperature: 0-40°C , temperature coefficient: 100ppm/°C

Parameter		IT8615L	V1.1
AC Section			
Input parameter	Input voltage	15~260Vrms , 360V peak	
	Current	0~20Arms ,60Apeak	
	Power	0~1800VA	
	Frequency	45~450Hz	
CC mode *1	Range	0.1~20Arms	
	Resolution	2mA	
	Accuracy	±(0.1%+0.2%FS)	
CR mode	Range	2Ω~2.5KΩ	

Parameter		IT8615L	V1.1
*2	Resolution	16bit	
	Accuracy	0.2% +0.01S	
CP mode	Range	1800W	
	Resolution	0.4W	
	Accuracy	0.5%+0.5%FS	
Crest Factor(CF) (in CP and CC mode)	Range	1.414~5.0	
	Resolution	0.005	
	Accuracy	(0.5% / Irms) + 1% FS	
Power Factor (PF)	Range	0-1 lead or lag	
	Resolution	0.001	
DC Section			
Input parameter	Input voltage	10~ 360	
	Input current	0.1~20A	
	Input power	0~1800 VA	
Operating Mode	CC, CV, CR and CP		
Short Circuit Simulation	The maximum power or current in CC mode		
Meter			
Current *1	Range	0~60A	
	Resolution	1mA	
	Accuracy	0.1%+0.2%FS+0.1%*CF^2*KHZ	
Voltage *1	Range	0~360V	
	Resolution	10mV	
	Accuracy	0.1%+0.1%FS	
Meter (continue)			
Other Parameters	S(VA),Q(VAR),P(W),Ip+,Ip-,Freq,THDv,CF,PF,R,FFT		
Other			
V monitor	±360v/±10V(Isolation)		
I monitor	±60A/±10V(Isolation)		
Protection	OCP:21Arms,OVP:286Vrms,OPP:1900W,OTP:85°C		
Interface	USB, LAN		

Parameter		IT8615L	V1.1
Dimension(WxHxD)	482.5 mm x 133mm x 600.6mm		
Weight	30KG		
AC Input	Voltage	100~240V AC	
	Frequency	47~63 Hz	
	Fuse	3.15A	
	Power	150VA	

*1. Typical parameter values in case of the 45-100HZ.

*2. The scope of read-back resistance is $(1 / (1/R+(1/R)*0.2\%+0.01), 1/(1/R-(1/R)*0.2\%-0.01))$.

Test condition: The voltage/current input is no less than 10% FS

The above specifications may be subject to change without prior notice.

Parameter		IT8616	V1.3
AC Section			
Input parameter	Input voltage	50~420Vrms , 600V peak	
	Current	0~40Arms , 120Apeak	
	Power	0-3600W	
	Frequency	45~450Hz	
CC mode *1	Range	0.2~40Arms	
	Resolution	2mA	
	Accuracy	$\pm(0.1\%+0.2\%FS)$	
CR mode *2	Range	1.5Ω~1.25KΩ	
	Resolution	16bit	
	Accuracy	0.2% +0.02S	
CP mode	Range	3600W	
	Resolution	0.4W	
	Accuracy	0.5%+0.5%FS	
Crest Factor(CF) (in CP and CC mode)	Range	1.414~5.0	
	Resolution	0.005	
	Accuracy	$(1\% / I_{rms}) + 1\% FS$	
Power Factor (PF)	Range	0~1 lead or lag	
	Resolution	0.001	
DC Section			

Parameter		IT8616	V1.3
Input parameter	Input voltage	10- 600V	
	Input current	0.2~40A	
	Input power	0-3600W	
Operating Mode	CC, CR, CP		
Short Circuit Simulation	The maximum power or current in CC mode		
Meter			
Current	Range	0-120A	
	Resolution	1mA	
	Accuracy	0.2%+0.2%FS+0.2%*CF^2*KHZ	
voltage	Range	0-600V	
	Resolution	10mV	
	Accuracy	0.1%+0.1%FS	
Meter (continue)			
Other Parameters	S(VA),Q(VAR),P(W),Ip+,Ip-,Freq,THDv,CF,PF,R,FFT		
Other			
V monitor	±600v/±10V(Isolation)		
I monitor	±120A/±10V(Isolation)		
Protection	OCP:42Arms,OVP:430Vrms,OPP:3700W,OTP:85°C		
Interface	USB, LAN		
Dimension	side plate structure: 483.00mm(W) *348.99mm (H)*641.08mm (D) cabinet: 50.0000 (W)*801.40 (H)*839.10mm (D)		
Weight	side plate structure: 75KG cabinet: 140KG		
AC Input	Voltage	100-240V AC	
	Frequency	47-63 Hz	
	Power	300VA	

*1. Typical parameter values in case of the 45-100HZ.

*2. The scope of read-back resistance is ($1/(1/R+(1/R)*0.2\%+0.01)$), $1/(1/R-(1/R)*0.2\%-0.01)$
Test condition: The voltage/current input is no less than 10% FS

*3. Operating temperature: 0-40°C , temperature coefficient: 100ppm/°C

Parameter		IT8617 (AC/DC Load)	V1.3
AC Section			
Parameter	Input voltage	50~420Vrms, 600V peak	
	Input current	0~60Arms, 180A peak	

	Input power	0-5400W
	Frequency	45~450Hz
CC mode *1	Range	0.3~60Arms
	Resolution	2mA
	Accuracy	±(0.1%+0.2%FS)
CR mode *2	Range	1Ω~833Ω
	Resolution	16bit
	Accuracy	0.2% +0.02S
CP mode	Range	5400W
	Resolution	0.4W
	Accuracy	0.5%+0.5%FS
Crest Factor(CF) (CP,CC mode)	Range	1.414~5.0
	Resolution	0.005
	Accuracy	(1.5% / Irms) + 1% FS
Power Factor (PF)	Range	0~1 lead or lag
	Resolution	0.001
DC Section		
Rating value	Input voltage	10~600V
	Input current	0.3~60A
	Input power	0-5400W
Working mode	CC,CP,CR	
Short circuit simulation	The max. power point or max. current in CC mode	
Meter		
Current	Range	0-180A
	Resolution	1mA
	Accuracy	0.2%+0.2%FS+0.2%*CF^2*KHZ
Voltage	Range	0-600V
	Resolution	10mV
	Accuracy	0.1%+0.1%FS
Meter(Continue)		
Other parameter	S(VA),Q(VAR),P(W),Ip+,Ip-,Freq,THDv,CF,PF,R,FFT	
Other		
Voltage Monitor	±600v/±10V(Isolated)	
Current Monitor	±180A/±10V(Isolated)	
Protection	OCP:63Arms,OVP:430Vrms,OPP:5500 W,OTP:85°C	
Interface	USB, LAN	
Dimension	side plate structure: 483.00mm (W)*482.34mm(H)*641.08mm(D) cabinet: 550.0000mm (W)*801.40(H)*807.5mm(D)	
Weight	side plate structure: 110KG cabinet: 165KG	
AC Input	Voltage	100-240V AC
	Frequency	47-63Hz
	Power	450VA
Parameter of each phase	IT8617 (AC/DC Load) V1.2	
	Three-Phase Mode	
	Delta or Star connection type are supported of IT8617.The connection depends on user's testing requirement.	
AC Section		
Parameter	Input voltage	50~420Vrms, 600V peak
	Input current	0~20Arms, 60A peak
	Input power	0-1800VA
	Frequency	45~450Hz

CC mode	Range	0.1~20Arms
	Resolution	2mA
	Accuracy	$\pm(0.1\%+0.2\%FS)$
CR mode *2	Range	3 Ω ~2.5K Ω
	Resolution	16bit
	Accuracy	0.2% +0.01S
CP mode	Range	1800W
	Resolution	0.4W
	Accuracy	0.5%+0.5%FS
Crest Factor(CF) (CP,CC mode)	Range	1.414~5.0
	Resolution	0.005
	Accuracy	$(0.5\%* / I_{rms}) + 1\% FS$
Power Factor (PF)	Range	0~1 lead or lag
	Resolution	0.001

*1, Typical condition: 45-100Hz

*2, Resistance accuracy range: $1/(1/R+(1/R)*0.2\%+0.01)$, $1/(1/R-(1/R)*0.2\%-0.01)$
 Test condition: voltage>10%FS, current>10%FS

*3 Operating Temperature:0-40°C.Temperature coefficient:100ppm/°C

Parameter		IT8624 V1.3
AC Section		
Parameter	Input voltage	50~420Vrms , 600V peak
	Input current	0~80Arms ,240Apeak
	Input power	0-7.2kW
	Frequency	45~450Hz
CC mode *1	Range	0.4~80Arms
	Resolution	20mA
	Accuracy	$\pm(0.2\%+0.2\%FS)$
CR mode *2	Range	0.75 Ω ~625 Ω
	Resolution	16bit
	Accuracy	0.2% +0.02S
CP mode	Range	7.2kW
	Resolution	1W
	Accuracy	0.5%+0.5%FS
Crest Factor(CF) (CP,CC mode)	Range	1.414~5.0
	Resolution	0.005
	Accuracy	$(2\% / I_{rms}) + 1\% FS$
Power Factor (PF)	Range	0~1 lead or lag
	Resolution	0.001

DC Section		
Rating value	Input voltage	10-600V
	Input current	0.4~80A
	Input power	0-7.2kW
Operating Mode	CC, CR, CP	
Short Circuit Simulation	The max. power point or max. current in CC mode	
Meter		
Current	Range	0-240A
	Resolution	5mA
	Accuracy	0.1%+0.2%FS+0.1%*CF ² *KHZ
Voltage	Range	0-600V
	Resolution	10mV
	Accuracy	0.1%+0.1%FS
Meter (continue)		
Other Parameters	S(VA),Q(VAR),P(W),Ip+,Ip-,Freq,THDv,CF,PF,R,FFT	
Other		
Voltage Monitor	±600v/±10V(Isolation)	
Current Monitor	±240A/±10V(Isolation)	
Protection	OCP:≈84Arms,OVP:≈430Vrms,OPP:≈7.5kW,OTP:85°C	
Interface	USB, LAN	
Dimension	600.00mm(W) * 1475.01mm(H) *841.1mm(D)	
Weight	255KG	
AC Input	Voltage	100-240V AC
	Frequency	47-63 Hz
	Working current	<7A(110V), <3.5A(220V)

*1, Typical parameter values in case of the 45-100HZ

*2, The scope of read-back resistance is $(1/(1/R+(1/R)*0.2\%+0.01), 1/(1/R-(1/R)*0.2\%-0.01))$
 Test condition: The voltage/current input is no less than 10% FS.

Parameter	IT8625 V1.3
AC Section	

Parameter	Input voltage	50~420Vrms , 600V peak
	Input current	0~100Arms ,300Apeak
	Input power	0-9kW
	Frequency	45~450Hz
CC mode *1	Range	0.5~100Arms
	Resolution	20mA
	Accuracy	$\pm(0.5\%+0.5\%FS)$
CR mode *2	Range	0.6 Ω ~500 Ω
	Resolution	16bit
	Accuracy	0.2% +0.02S
CP mode	Range	9kW
	Resolution	3W
	Accuracy	0.5%+0.5%FS
Crest Factor(CF) (CP,CC mode)	Range	1.414~5.0
	Resolution	0.005
	Accuracy	$(2.5\% / I_{rms}) + 1\% FS$
Power Factor (PF)	Range	0~1 lead or lag
	Resolution	0.001
DC Section		
Rating value	Input voltage	10-600V
	Input current	0.5~100A
	Input power	0-9kW
Operating Mode	CC, CR, CP	
Short Circuit Simulation	The max. power point or max. current in CC mode	
Meter		
Current	Range	0-300A
	Resolution	0.1A
	Accuracy	$0.1\%+0.2\%FS+0.1\%*CF^2*KHZ$
Voltage	Range	0-600V
	Resolution	10mV
	Accuracy	0.1%+0.1%FS

Meter (continue)		
Other Parameters	S(VA),Q(VAR),P(W),Ip+,Ip-,Freq,THDv,CF,PF,R,FFT	
Other		
Voltage Monitor	±600v/±10V(Isolation)	
Current Monitor	±300A/±10V(Isolation)	
Protection	OCP:≈110Arms,OVP:≈430Vrms,OPP:≈9.5kW,OTP:85°C	
Interface	USB, LAN	
Dimension	600.00mm(W) * 1475.01mm(H) *841.1mm(D)	
Weight	290KG	
AC Input	Voltage	100-240V AC
	Frequency	47-63 Hz
	Working current	<7.6A(110V), <3.8A(220V)

*1, Typical parameter values in case of the **45-100HZ**

*2, The scope of read-back resistance is $(1/(1/R+(1/R)*0.2\%+0.01),1/(1/R-(1/R)*0.2\%-0.01))$
 Test condition: The voltage/current input is no less than 10% FS.

Parameter	IT8626 V1.3	
AC Section		
Parameter	Input voltage	50~420Vrms , 600V peak
	Input current	0~120Arms ,360Apeak
	Input power	0-10.8kW
	Frequency	45~450Hz
CC mode *1	Range	0.1~120Arms
	Resolution	20mA
	Accuracy	±(0.5%+0.5%FS)
CR mode *2	Range	0.5Ω~416.6Ω
	Resolution	16bit
	Accuracy	0.2% +0.02S
CP mode	Range	10.8kW
	Resolution	3W
	Accuracy	0.5%+0.5%FS
Crest Factor(CF)	Range	1.414~5.0

(CP,CC mode)	Resolution	0.005
	Accuracy	(3% / Irms) + 1% FS
Power Factor (PF)	Range	0~1 lead or lag
	Resolution	0.001
DC Section		
Rating value	Input voltage	10-600V
	Input current	0.1~120A
	Input power	0-10.8kW
Operating Mode	CC, CR, CP	
Short Circuit Simulation	The max. power point or max. current in CC mode	
Meter		
Current	Range	0-360A
	Resolution	0.1A
	Accuracy	0.1%+0.2%FS+0.1%*CF ² *KHZ
Voltage	Range	0-600V
	Resolution	10mV
	Accuracy	0.1%+0.1%FS
Meter (continue)		
Other Parameters	S(VA),Q(VAR),P(W),Ip+,Ip-,Freq,THDv,CF,PF,R,FFT	
Other		
Voltage Monitor	±600v/±10V(Isolation)	
Current Monitor	±360A/±10V(Isolation)	
Protection	OCP:≈125Arms,OVP:≈430Vrms,OPP:≈11kW,OTP:85°C	
Interface	USB, LAN	
Dimension	600.00mm(W) * 1475.01mm(H) *841.1mm(D)	
Weight	315KG	
AC Input	Voltage	100-240V AC
	Frequency	47-63 Hz
	Working current	<9A(110V), <4.5A(220V)

*1, Typical parameter values in case of the 45-100HZ

*2, The scope of read-back resistance is (1/(1/R+(1/R)*0.2%+0.01),1/(1/R-(1/R)*0.2%-0.01)

Test condition: The voltage/current input is no less than 10% FS.

Parameter		IT8627 V1.2
AC Section		
Parameter	Input voltage	50~420Vrms , 600V peak
	Input current	0~140Arms ,420Apeak
	Input power	0-12.6kW
	Frequency	45~450Hz
CC mode *1	Range	0.7~140Arms
	Resolution	20mA
	Accuracy	$\pm(0.5\%+0.5\%FS)$
CR mode *2	Range	0.5 Ω ~350 Ω
	Resolution	16bit
	Accuracy	0.2% +0.02S
CP mode	Range	12.6kW
	Resolution	3W
	Accuracy	0.5%+0.5%FS
Crest Factor(CF) (CP,CC mode)	Range	1.414~5.0
	Resolution	0.005
	Accuracy	$(3.5\% / I_{rms}) + 1\% FS$
Power Factor (PF)	Range	0~1 lead or lag
	Resolution	0.001
DC Section		
Rating value	Input voltage	10-600V
	Input current	0.7~140A
	Input power	0-12.6kW
Operating Mode	CC, CR, CP	
Short Circuit Simulation	The max. power point or max. current in CC mode	
Meter		
Current	Range	0-420A
	Resolution	0.1A
	Accuracy	$0.1\%+0.2\%FS+0.1\%*CF^2*KHZ$
Voltage	Range	0-600V

	Resolution	10mV
	Accuracy	0.1%+0.1%FS
Meter (continue)		
Other Parameters	S(VA),Q(VAR),P(W),Ip+,Ip-,Freq,THDv,CF,PF,R,FFT	
Other		
Voltage Monitor	±600v/±10V(Isolation)	
Current Monitor	±420A/±10V(Isolation)	
Protection	OCP:≈150rms,OVP:≈430Vrms,OPP:≈12.6kW,OTP:85°C	
Interface	USB, LAN	
Dimension	600.00mm(W) * 1919.40(H) *841.1mm(D)	
Weight	380KG	
AC Input	Voltage	100-240V AC
	Frequency	47-63 Hz
	Working current	<10.4A(110V), <5.2A(220V)

*1, Typical parameter values in case of the 45-100HZ

*2, The scope of read-back resistance is($1/(1/R+(1/R)*0.2\%+0.01)$, $1/(1/R-(1/R)*0.2\%-0.01)$
 Test condition: The voltage/current input is no less than 10% FS.

Parameter		IT8628 V1.3
AC Section		
Parameter	Input voltage	50~420Vrms , 600V peak
	Input current	0~160Arms ,480Apeak
	Input power	0-14.4kW
	Frequency	45~450Hz
CC mode *1	Range	0.8~160Arms
	Resolution	20mA
	Accuracy	±(0.5%+0.5%FS)
CR mode *2	Range	0.375Ω~312.5Ω
	Resolution	16bit
	Accuracy	0.2% +0.02S
CP mode	Range	14.4kW
	Resolution	3W
	Accuracy	0.5%+0.5%FS

Crest Factor(CF) (CP,CC mode)	Range	1.414~5.0
	Resolution	0.005
	Accuracy	(4% / Irms) + 1% FS
Power Factor (PF)	Range	0~1 lead or lag
	Resolution	0.001
DC Section		
Rating value	Input voltage	10-600V
	Input current	0.8~160A
	Input power	0-14.4kW
Operating Mode	CC, CR, CP	
Short Circuit Simulation	The max. power point or max. current in CC mode	
Meter		
Current	Range	0-480A
	Resolution	0.1A
	Accuracy	0.1%+0.2%FS+0.1%*CF ² *KHZ
Voltage	Range	0-600V
	Resolution	10mV
	Accuracy	0.1%+0.1%FS
Meter (continue)		
Other Parameters	S(VA),Q(VAR),P(W),Ip+,Ip-,Freq,THDv,CF,PF,R,FFT	
Other		
Voltage Monitor	±600v/±10V(Isolation)	
Current Monitor	±480A/±10V(Isolation)	
Protection	OCP:≈185rms,OVP:≈430Vrms,OPP:≈14.6kW,OTP:85°C	
Interface	USB, LAN	
Dimension	600.00mm(W) * 1919.40(H) *841.1mm(D)	
Weight	420KG	
AC Input	Voltage	100-240V AC
	Frequency	47-63 Hz
	Working current	<12A(110V), <6A(220V)

*1, Typical parameter values in case of the 45-100HZ

*2, The scope of read-back resistance is($1/(1/R+(1/R)*0.2\%+0.01)$, $1/(1/R-(1/R)*0.2\%-0.01)$)

Test condition: The voltage/current input is no less than 10% FS.

10.2 Supplemental characteristics

- Recommended calibration frequency
Once a year
- Cooling style
Fans

Appendix

Specifications of Red and Black Test Lines

ITECH provides you with optional red and black test lines, which individual sales and you can select for test. For specifications of ITECH test lines and maximum current values, refer to the table below.

Model	Specification	Length	Description
IT-E30110-AB	10A	1m	A pair of red and black test cables with an alligator clip at one end and a banana plug at the other end
IT-E30110-BB	10A	1m	A pair of red and black test cables with banana plugs at both ends
IT-E30110-BY	10A	1m	A pair of red and black test cables with a banana plug at one end and a Y-terminal at the other end
IT-E30312-YY	30A	1.2m	A pair of red and black test cables with Y-terminals at both ends
IT-E30320-YY	30A	2m	A pair of red and black test cables with Y-terminals at both ends
IT-E30615-OO	60A	1.5m	A pair of red and black test cables with round terminals at both ends
IT-E31220-OO	120A	2m	A pair of red and black test cables with round terminals at both ends
IT-E32410-OO	240A	1m	A pair of red and black test cables with round terminals at both ends
IT-E32420-OO	240A	2m	A pair of red and black test cables with round terminals at both ends
IT-E33620-OO	360A	2m	A pair of red and black test cables with round terminals at both ends

For maximum current of AWG copper wire, refer to table below.

AWG	10	12	14	16	18	20	22	24	26	28
The Maximum current value(A)	40	25	20	13	10	7	5	3.5	2.5	1.7

Note: AWG (American Wire Gauge), it means X wire (marked on the wire). The table above lists current capacity of single wire at working temperature of 30°C. For reference only.

Contact US

Thank you for purchasing ITECH products. If you have any doubt about this product, please contact us as follows.

1. Visit ITECH website www.itechate.com.
2. Select the most convenient contact for further consultation.