

# Internal Resistance Tester

## IT5101 User Manual

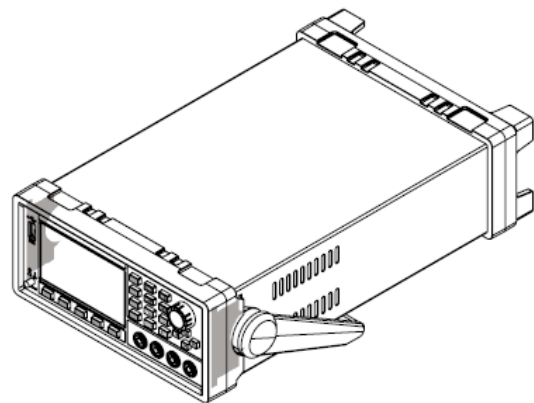

---

Model: IT5101/IT5101E/IT5101H

Version: V2.2

## Notices

© Itech Electronic, Co., Ltd. 2021  
No part of this manual may be reproduced in any form or by any means (including electronic storage and retrieval or translation into a foreign language) without prior permission and written consent from Itech Electronic, Co., Ltd. as governed by international copyright laws.

### Manual Part Number

IT5101-402530

### Revision

2nd Edition: Jun. 25, 2021  
Itech Electronic, Co., Ltd.

### Trademarks

Pentium is U.S. registered trademarks of Intel Corporation.

Microsoft, Visual Studio, Windows and MS Windows are registered trademarks of Microsoft Corporation in the United States and/or other countries and regions.

## Warranty

The materials contained in this document are provided “as is”, and is subject to change, without prior notice, in future editions. Further, to the maximum extent permitted by applicable laws, ITECH disclaims all warrants, either express or implied, with regard to this manual and any information contained herein, including but not limited to the implied warranties of merchantability and fitness for a particular purpose. ITECH shall not be held liable for errors or for incidental or indirect damages in connection with the furnishing, use or application of this document or of any information contained herein. Should ITECH and the user enter into a separate written agreement with warranty terms covering the materials in this document that conflict with these terms, the warranty terms in the separate agreement shall prevail.

### Technology Licenses

The hardware and/or software described herein are furnished under a license and may be used or copied only in accordance with the terms of such license.

### Restricted Rights Legend

Restricted permissions of the U.S. government. Permissions for software and technical data which are authorized to the U.S. Government only include those for custom provision to end users. ITECH provides this customary commercial license in software and technical data pursuant to FAR 12.211 (Technical Data) and 12.212 (Computer Software) and, for the Department of Defense, DFARS 252.227-7015 (Technical Data – Commercial Items) and DFARS 227.7202-3 (Rights in Commercial Computer Software or Computer Software Documentation).

## Safety Notices

### CAUTION

A CAUTION sign denotes a hazard. It calls attention to an operating procedure or practice that, if not correctly performed or adhered to, could result in damage to the product or loss of important data. Do not proceed beyond a CAUTION sign until the indicated conditions are fully understood and met.

---

### WARNING

A WARNING sign denotes a hazard. It calls attention to an operating procedure or practice that, if not correctly performed or adhered to, could result in personal injury or death. Do not proceed beyond a WARNING sign until the indicated conditions are fully understood and met.

---



### NOTE

A NOTE sign denotes important hint. It calls attention to tips or supplementary information that is essential for users to refer to.

## Quality Certification and Assurance

We certify that IT5101 internal resistance tester meets all the published specifications at time of shipment from the factory.

## Warranty

ITECH warrants that the product will be free from defects in material and workmanship under normal use for a period of one (1) year from the date of delivery (except those described in the Limitation of Warranty below).

For warranty service or repair, the product must be returned to a service center designated by ITECH.















- The product returned to ITECH for warranty service must be shipped PREPAID. And ITECH will pay for return of the product to customer.
- If the product is returned to ITECH for warranty service from overseas, all the freights, duties and other taxes shall be on the account of customer.

## Limitation of Warranty

This Warranty will be rendered invalid if the product is:

- Damaged resulting from customer-wired circuits or customer-supplied parts or accessories;
- Modified or repaired by customer without authorization;
- Damaged resulting from customer-wired circuits or use in an environment not designated by us;
- The product model or serial number is altered, deleted, removed or made illegible by customer;
- Damaged as a result of accidents, including but not limited to lightning, moisture, fire, improper use or negligence.

## Safety Symbols

	Direct current		ON (power)
	Alternating current		OFF (power)
	Both direct and alternating current		Power-on state
	Chassis (earth ground) symbol.		Power-off state
	Earth (ground) terminal		Reference terminal
	Caution		Positive terminal
	Warning (refer to this manual for specific Warning or Caution information)		Negative terminal
	A chassis terminal	-	-

## Safety Precautions

The following safety precautions must be observed during all phases of operation of this instrument. Failure to comply with these precautions or specific warnings elsewhere in this manual will constitute a default under safety standards of design, manufacture and intended use of the instrument. ITECH assumes no liability for the customer's failure to comply with these precautions.

### WARNING

- **Do not use the instrument if it is damaged. Before operation, check the casing to see whether it cracks. Do not operate the instrument in the presence of inflammable gasses, vapors or dusts.**
- **The internal resistance tester is provided with a three-core power line during delivery and should be connected to three-core junction box. Before operation, be sure that the internal resistance tester is well grounded. Make sure to use the power cord supplied by ITECH.**
- **Check all marks on the instrument before connecting the instrument to power supply.**
- **Use electric wires of appropriate load. All loading wires should be capable of bearing maximum short-circuit of electronic load without overheating. If there are multiple loads, each pair of the load power cord must be carry out the full rated short-circuit output current of the power securely.**
- **Ensure the voltage fluctuation of mains supply is less than 10% of the working voltage range in order to reduce risks of fire and electric shock.**
- **Do not install alternative parts on the instrument or perform any unauthorized modification.**
- **Do not use the instrument if the detachable cover is removed or loosen.**
- **To prevent the possibility of accidental injuries, be sure to use the power adapter supplied by the manufacturer only.**
- **We do not accept responsibility for any direct or indirect financial damage or loss of profit that might occur when using the instrument.**
- **This instrument is used for industrial purposes. Do not apply this product to IT power supply system.**
- **Never use the instrument with a life-support system or any other equipment subject to safety requirements.**

### CAUTION

- **Failure to use the instrument as directed by the manufacturer may render its protective features void.**
- **Always clean the casing with a dry cloth. Do not clean the internals.**
- **Make sure the vent hole is always unblocked.**

## Environmental Conditions

The instrument is designed for indoor use and an area with low condensation. The table below shows the general environmental requirements for the instrument.



Environmental Conditions	Requirements
Operating temperature	0°C to 40°C

Operating humidity	20%-80% (non-condensation)
Storage temperature	-20°C to 70 °C
Altitude	Operating up to 2,000 meters
Installation category	II
Pollution degree	Pollution degree 2

**Note**

To make accurate measurements, allow the instrument to warm up for 30 min.

## Regulatory Markings

	<p>The CE mark indicates that the product complies with all the relevant European legal directives. The specific year (if any) affixed refers to the year when the design was approved.</p>
	<p>The instrument complies with the WEEE Directive (2002/96/EC) marking requirement. This affix product label indicates that you must not discard the electrical/electronic product in domestic household waste.</p>
	<p>This symbol indicates the time period during which no hazardous or toxic substances are expected to leak or deteriorate during normal use. The expected useful life of the product is 10 years. The product can be used safely during the 10-year Environment Friendly Use Period (EFUP). Upon expiration of the EFUP, the product must be immediately recycled.</p>

## Waste Electrical and Electronic Equipment (WEEE) Directive



2002/96/EC Waste Electrical and Electronic Equipment (WEEE) Directive

This product complies with the WEEE Directive (2002/96/EC) marking requirement. This affix product label indicates that you must not discard the electrical/electronic product in domestic household waste.

Product Category

With reference to the equipment classifications described in the Annex 1 of the WEEE Directive, this instrument is classified as a "Monitoring and Control Instrument".

To return this unwanted instrument, contact your nearest ITECH office.

## Compliance Information

Complies with the essential requirements of the following applicable European Directives, and carries the CE marking accordingly:

- Electromagnetic Compatibility (EMC) Directive 2014/30/EU
- Low-Voltage Directive (Safety) 2014/35/EU

Conforms with the following product standards:

### EMC Standard

IEC 61326-1:2012/ EN 61326-1:2013 <sup>123</sup>

#### Reference Standards

CISPR 11:2009+A1:2010/ EN 55011:2009+A1:2010 (Group 1, Class A)

IEC 61000-4-2:2008/ EN 61000-4-2:2009

IEC 61000-4-3:2006+A1:2007+A2:2010/ EN 61000-4-3:2006+A1:2008+A2:2010

IEC 61000-4-4:2004+A1:2010/ EN 61000-4-4:2004+A1:2010

IEC 61000-4-5:2005/ EN 61000-4-5:2006

IEC 61000-4-6:2008/ EN 61000-4-6:2009

IEC 61000-4-11:2004/ EN 61000-4-11:2004

1. The product is intended for use in non-residential/non-domestic environments. Use of the product in residential/domestic environments may cause electromagnetic interference.
2. Connection of the instrument to a test object may produce radiations beyond the specified limit.
3. Use high-performance shielded interface cable to ensure conformity with the EMC standards listed above.

### Safety Standard

IEC 61010-1:2010/ EN 61010-1:2010

# CONTENT

Quality Certification and Assurance .....	3
Warranty.....	3
Limitation of Warranty .....	3
Safety Symbols .....	3
Safety Precautions.....	4
Environmental Conditions .....	4
Regulatory Markings .....	5
Waste Electrical and Electronic Equipment (WEEE) Directive .....	5
Compliance Information.....	6
<b>Chapter1      Inspection and Installation .....</b>	<b>1</b>
1.1 Verifying the Shipment.....	1
1.2 Optional Accessories .....	1
1.3 Instrument Size Introduction.....	5
1.4 Dimension .....	5
1.5 Adjusting the Handle .....	6
1.6 Removing the Handle .....	7
1.7 Rack Mounting .....	7
1.8 Connecting the Power Cord.....	7
1.9 Connecting Test Lines ( Optional) .....	8
<b>Chapter2      Quick Start.....</b>	<b>10</b>
2.1 Brief Introduction .....	10
2.2 Features.....	10
2.3 Front Panel Introduction .....	11
2.4 Introduction to keyboard.....	11
2.5 Screen Indicator Lamps Description .....	12
2.6 Rear Panel Introduction.....	12
2.7 Power-on Selftest .....	13
<b>Chapter3      Function and Features .....</b>	<b>15</b>
3.1 Range Setting.....	15
3.2 Sampling Rate Setting .....	16
3.3 System Menu.....	16
3.4 Reset System .....	18
3.5 Frequency Filter Setting .....	19
3.6 Alarm Mode Setting .....	20
3.7 Compare Function.....	20
3.8 Calculate Function .....	22
3.9 Average Function Setting .....	23
3.10 Trigger Function Setting .....	24
3.11 Statistics On/Off Setting .....	25
3.12 Save/Recall Function .....	25
3.13 Screen Capture Function .....	26
3.14 Statistics Function .....	26
3.14.1 View Statistic Results .....	27
3.14.2 Display List.....	27
3.14.3 Display Normal Distribution Plot.....	28
3.14.4 Save/Recall Measurement Data .....	28
3.15 Zero-Adjust Function .....	29
3.16 External Control(EXT I/O) .....	31
3.17 ERR Output.....	34
3.18 Setting EOM Signal .....	35
3.19 Timing Chart .....	36
<b>Chapter4      Routine Maintenance .....</b>	<b>38</b>

---

4.1 Self-test.....	38
4.2 Routine Maintenance.....	38
4.3 Contact ITECH Engineer.....	38
4.4 Return for Repair.....	40
<b>Chapter5 Remote Control .....</b>	<b>41</b>
5.1 USB Interface.....	41
5.2 GPIB Interface.....	41
5.3 LAN Interface.....	41
<b>Chapter6 Specification .....</b>	<b>42</b>
6.1 Main technical parameters.....	42
6.2 Supplemental characteristics .....	44



# Chapter1 Inspection and Installation

## 1.1 Verifying the Shipment

Unpack the box and check the contents before operating the instrument. If wrong items have been delivered, if items are missing, or if there is a defect with the appearance of the items, contact the dealer from which you purchased the instrument immediately. The package contents include:

Checklist of Package Contents:

Item	Qty.	Model	Remarks
Internal Resistance Tester	x1	IT5101/IT5101E/ T5101H	-
Power Cord	x1	IT-E171/IT-E172/ IT-E173/IT-E174	User may select an appropriate power cord that matches the specifications of power socket used in the area. See the Section <b>Connecting the Power Cord</b> for details.
USB cable	x1	-	This accessory is selected when the USB interface is used for starting up remote operation.
Ex-factory Test Report	x1	-	It is the test report of the instrument before delivery.



### NOTE

Upon verification of the shipment, keep the package and relevant contents thereof in a safe place. When returning the instrument for warranty service or repair, the specified packing requirements shall be met.

## 1.2 Optional Accessories

IT5101 series internal resistance tester is supplied with the following optional accessories (sold separately):

### Rack Mount Kit

This accessory is used to mount the instrument to special rack. ITECH provides two models of rack mount kits: IT-E151 and IT-E151A. For detailed installation process, refer to **1.7 Rack Mounting**.

### Test Lines

ITECH provides alone-sold test lines for professional measure. Test lines in sold and related introduction are shown below. All lengths in the figure are in mm.

- IT-E601 IT-E601 Pin type lead (Under DC600V)

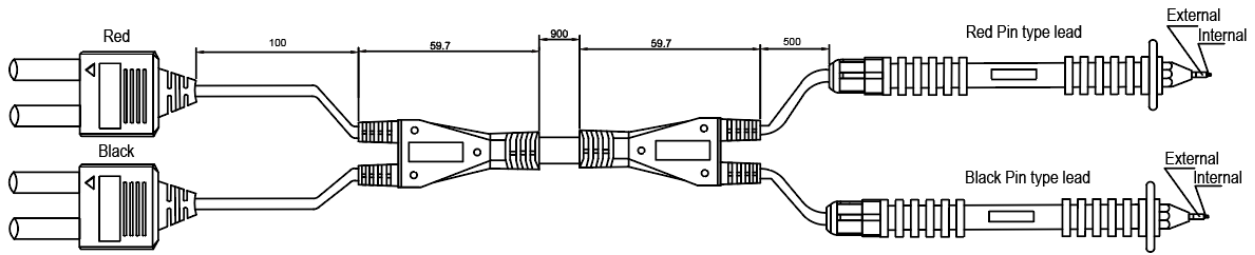

Either for plane contacts or relay terminals that are not easy to clamp or small objects like connectors, you just need to touch the test lines against the DUT for four-terminal measurement. The meter pen can be directly unscrewed for changing. For detailed length specification, see the figure above.

The central probe of the meter pen is Sense and the outer cylinder probe is Source terminal. The schematic diagram is as shown below.

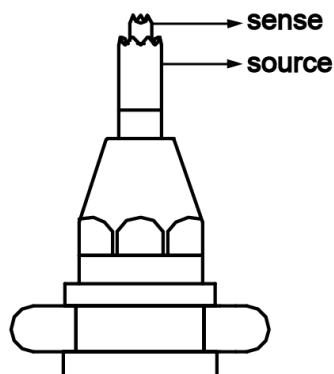

- IT-E602 Large clip type lead for small component test (Under DC600V)

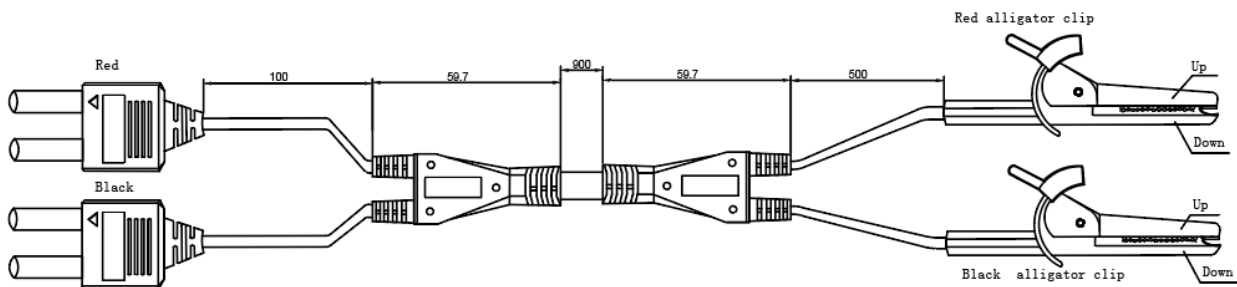

It can be used to clamp thick cylinder parts of DUT and is easy for operation. To take four-terminal measurement, directly clamp the DUT terminals. For detailed length specification, see the figure above.

The upper-jaw probe of alligator clip is Source terminal and the lower-jaw probe is Sense terminal. The schematic diagram is as shown below.

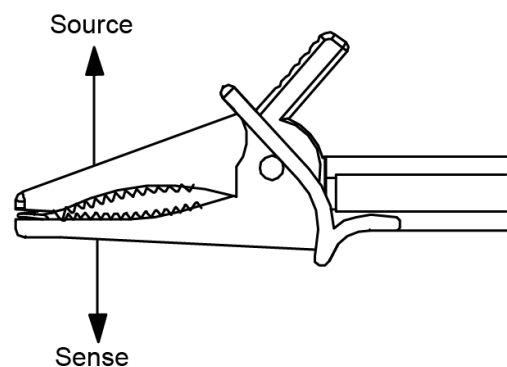

- IT-E603 Pin type lead for high-voltage battery test (Under DC600V)

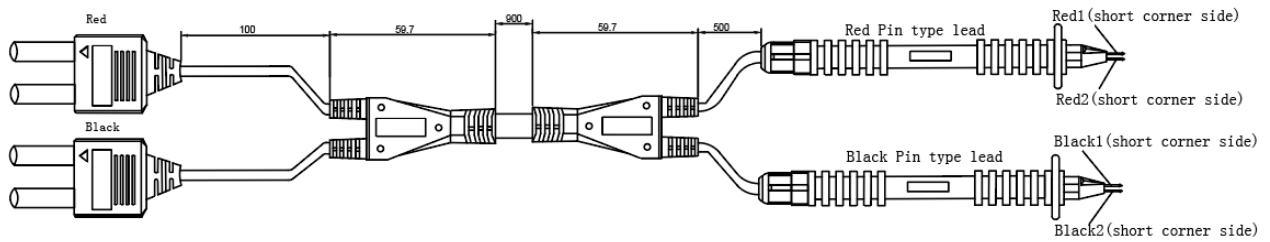

The test lines are needle-type test lines with high dielectric strength designed for DC300V (CATI) four-terminal structure, especially for high-voltage battery packs or batteries with high docking ground potential. Two parallel pins are designed at top for measurement through stable touch. The meter pins are changeable. For detailed length specifications, see the figure above.

In the two meter pens, the one at the short corner side is Sense terminal and the other is Source terminal. The schematic diagram is as shown below.

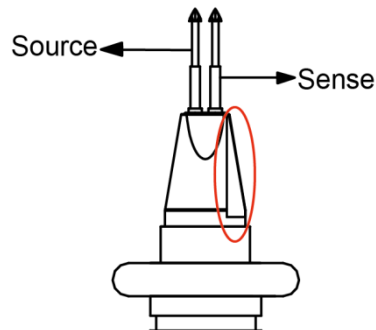

- IT-E604 4-terminal testing lead (Under DC600V)

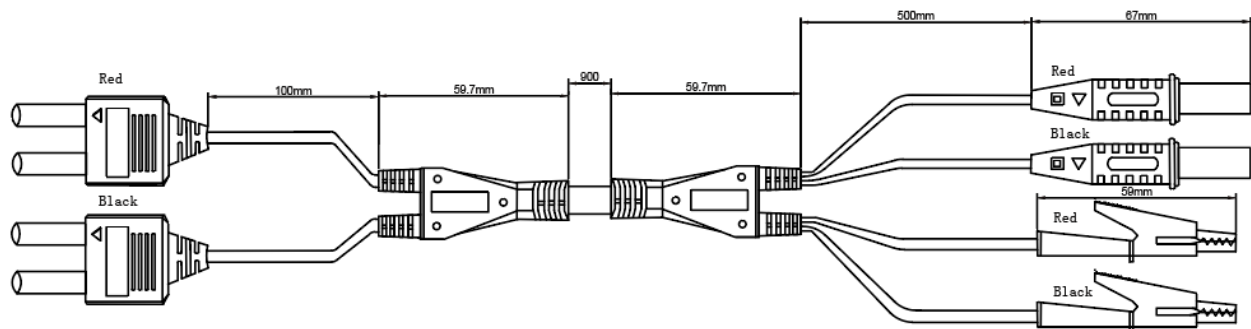

The four-terminal test lines can connect and test DUT intuitively and conveniently.

The alligator clip is Source terminal and rubber plug is Sense terminal (Another matching a pair of alligator clip and a pair of pin type lead). The schematic diagram is as shown below.

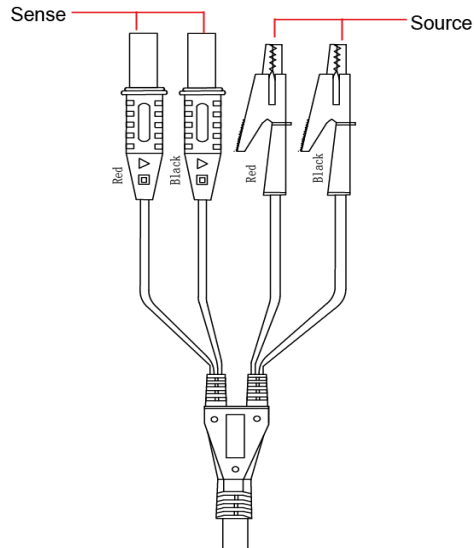

## Zero adjustment board

For zeroing, you need ITECH IT-E605 zeroing plate. The front and back sides of the zeroing plate are as shown below.

Front side:

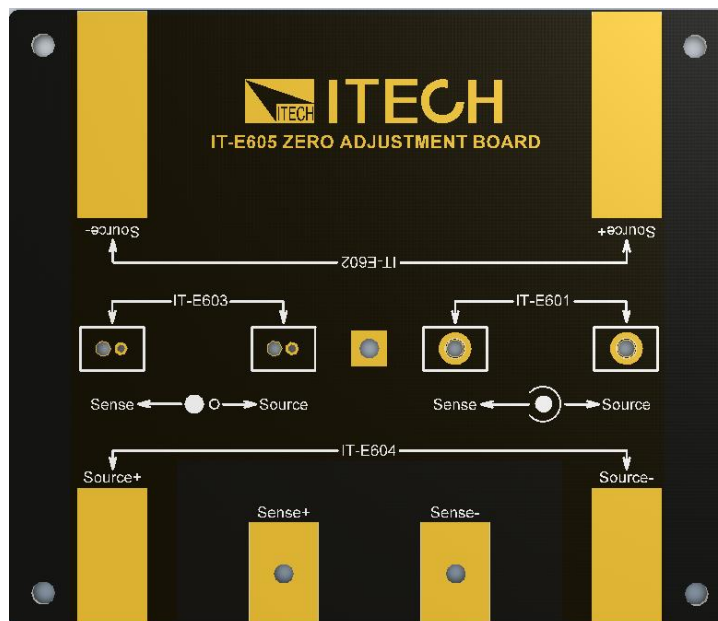

- IT-E601: wiring area for zeroing by IT-E601 testing lines.  
 Or, the user can directly insert the crown-head meter pen to the corresponding wiring holes in IT-E601. The outer circle corresponds to Source terminal and the inner core corresponds to Sense terminal. There is no positive and negative difference.
- IT-E602: wiring area for zeroing by IT-E602 testing lines.  
 Directly clamp wiring end of IT-E602 area with the alligator clip, where the Source and Sense terminals correspond to the gold-plated areas at front and back. Pay attention to positive and negative identifications.
- IT-E603: wiring area for zeroing by IT-E603 testing lines.  
 Directly insert two probes to corresponding holes of Source and Sense terminals. There is no positive and negative difference.

- IT-E604: wiring area for zeroing by IT-E604 testing lines.  
Connect the four terminals of the test line to wiring areas respectively based on identifications on the gold-plated area. Pay attention to positive and negative identifications.

Back side:

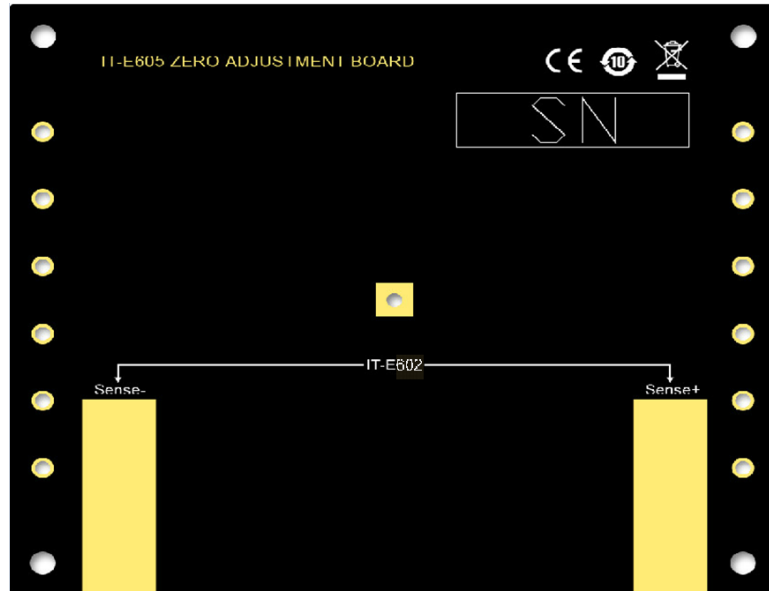

IT-E602: wiring area for zeroing by IT-E601 testing lines. The test line has alligator clips. Directly clamp the clips to connect Source and Sense terminals.

## 1.3 Instrument Size Introduction

The instrument should be installed at well-ventilated and rational-sized space. Please select appropriate space for installation based on the internal resistance tester size.

## 1.4 Dimension

The detail size of the internal resistance tester is shown as below.

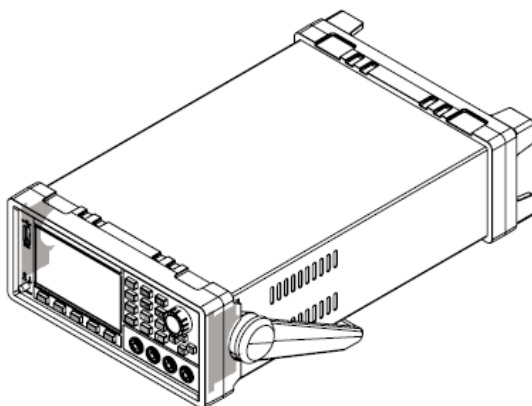

Dimension:  
width: 226mm  
Height: 105.18mm  
Depth: 383.92mm

Dimension

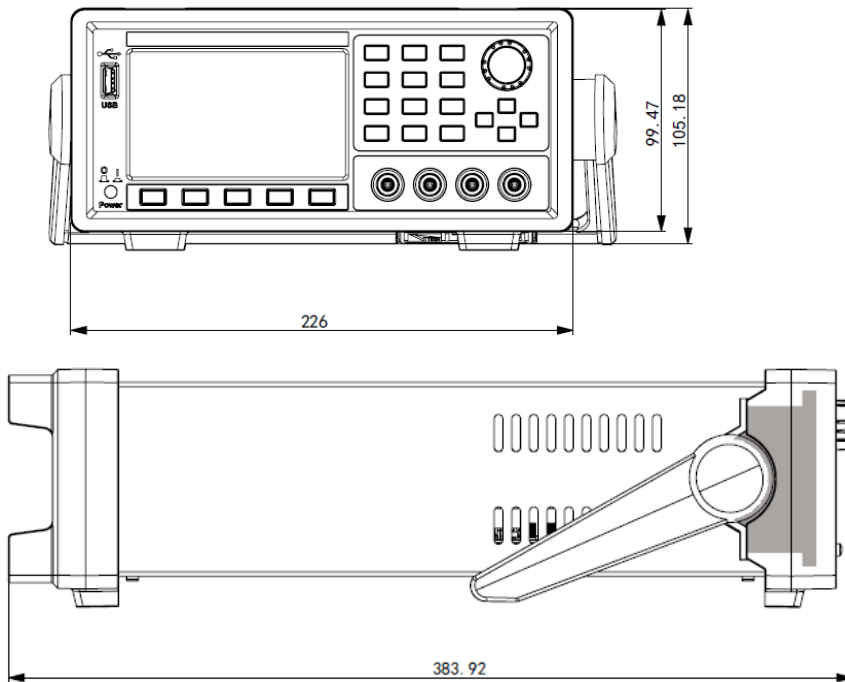

## 1.5 Adjusting the Handle

The instrument is equipped with a handle for user to easily carry and place it.

The handle can be adjusted in three manners as shown in the figure below. To adjust the handle, first pull out the handle gently toward the left and right sides of the instrument, and then rotate it slowly to its alignment keys.

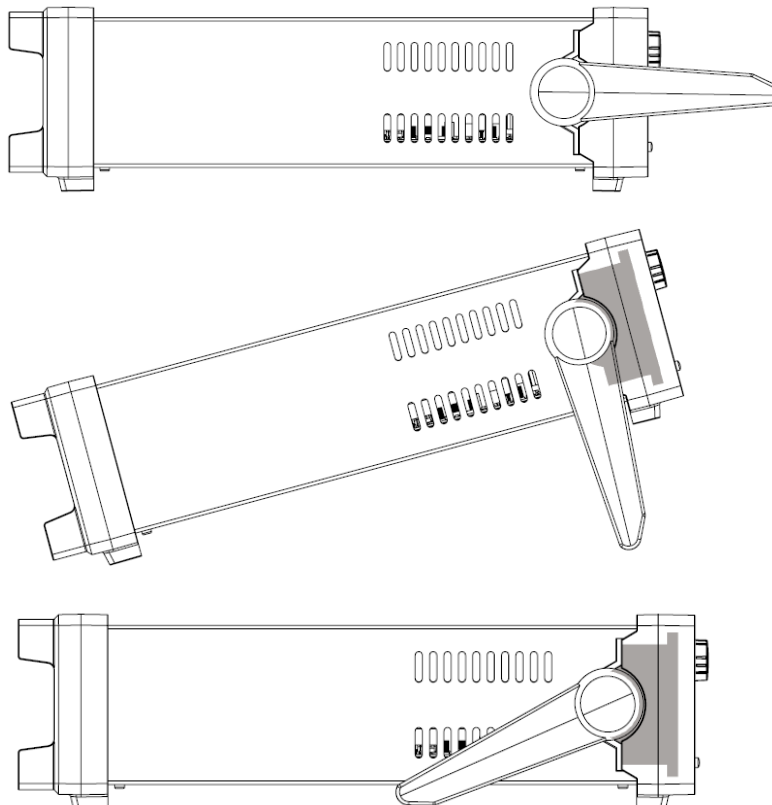

## 1.6 Removing the Handle

To mount the instrument on a rack, first remove the handle from the instrument.

The handle can be removed following the procedures below:

1. Rotate the handle to the position as shown in the following figure.

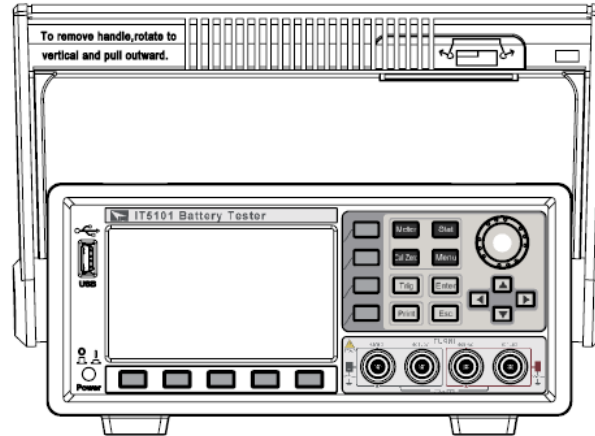

### NOTE

The handle can be easily removed from the alignment hole and key between the handle and the instrument.

2. Pull out the handle toward the left and right sides of the instrument from the alignment hole.



### NOTE

When mounting or removing the handle, do not squeeze it too hard and mind your hand.

## 1.7 Rack Mounting

IT5101 can be mounted on a standard 19" rack. ITECH provides user with IT-E151/IT-E151A rack, as an optional mount kit. The detailed operation please refer to the User Manual of your mount kit.

## 1.8 Connecting the Power Cord

Before connecting the power cord, please ensure the power switch of the instrument is turned OFF. Only use the power cord supplied as a standard accessory. The range of working voltage is AC100V~AC240V.

A summary of connection procedures is given below.

Select from the following Schedule of Power Cord Specifications an appropriate power cord that matches the voltage for the area in which you use the instrument. If the power cord included in the instrument you purchased does not match the voltage, contact the dealer or manufacturer for change.

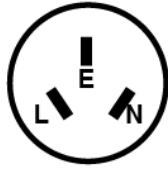

China  
IT-E171



United States &  
Canada & Japan  
IT-E172

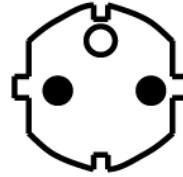

Europe  
IT-E173



England  
IT-E174

## 1.9 Connecting Test Lines ( Optional)

### WARNING

- To avoid burning out, be sure to confirm that power voltage matches with supply voltage.
- To avoid electrical shock, before testing, please make sure the rating values of the testing lines, and do not measure the voltage that higher than the rating value.
- To avoid battery short circuit, be sure to check that the test line end is not connected when connecting or disassembling the test line. When the test line end is connected with battery, short circuit may cause severe accident.

The test lines are not standard accessories of the instrument and are for individual sales. Please select them based on actual usage. This instrument has a socket terminal for resistance measurement that is independent from four terminals for details, refer to test line introduction in “1.1 Verifying the Shipment”.

1. Before connecting the test lines, be sure that the instrument Power is in Off position.
2. Please check that the top of four-terminal test line is not connected.
3. Connect the 4-terminal test line to the input terminal.

Connect the red test line to the red terminal, and the black test line to the black terminal. Match the red sense ▼ symbol at the front panel to the ▲ symbol of red test line, and the black sense ▼ symbol to the ▲ symbol of black test line.

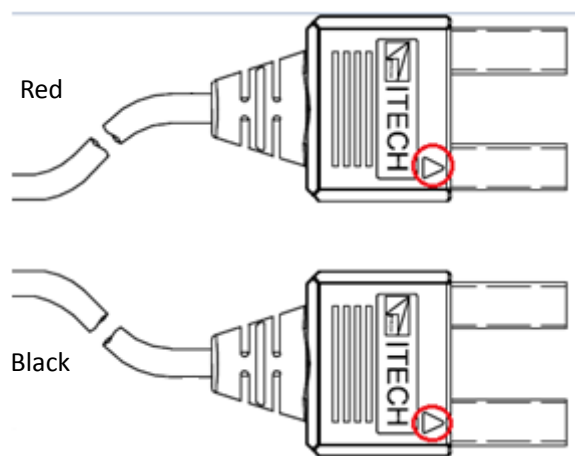



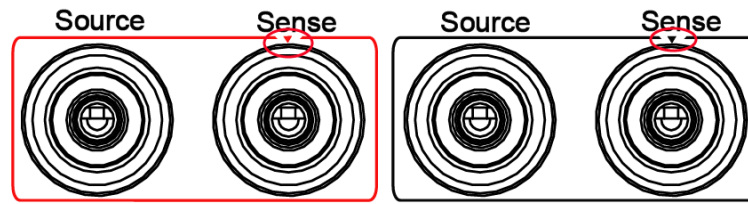

4. Connect the other side to the DUT terminal based on current test line type.

## Chapter2 Quick Start

This chapter introduces power-on check steps of IT5101 to ensure normal start-up and usage under initialization status. This part also introduces the front panel, the rear panel, and key functions of internal resistance tester, make sure that you can quickly know the appearance, instruction and the key function before you operate the instrument. Help you make better use of this series of internal resistance tester.

### 2.1 Brief Introduction

IT5101 series is a series of battery internal resistance testers with high precision, high resolution and high speed. IT5101 adopts AC 4-terminal sensing, that means the tester can test internal resistance and voltage simultaneously with high precision. Resistance resolution is down to  $0.1 \mu\Omega$ , voltage resolution is  $10 \mu\text{V}$ . Combined with external USB disk, IT5101 series can be widely applied in cellphone lithium batteries, electric vehicle batteries and other batteries inspection and sorting.

### 2.2 Features

IT5101 Series internal resistance tester is featured with:

- Support resistance & voltage simultaneously test and display
- Measure accuracy of battery internal resistance: 0.4%;
- Measurement accuracy of battery voltage: 0.01%;
- Maximum voltage measurement resolution:  $10\mu\text{V}$
- Maximum resistance measurement resolution of IT5101/IT5101H model:  $0.1\mu\Omega$
- Maximum resistance measurement resolution of IT5101E model:  $10\mu\Omega$
- Supports VISA / USBTMC/ SCPI protocol
- Automatically judge whether test results exceed set specifications based on the maximum/minimum limitation of test parameters
- Built-in USB, LAN interfaces
- Select multi-measurement speed based on requirements
- Statistics calculation and data USB storage function
- Software monitoring via computer
- Software-based calibration
- 4.3 inch LCD screen

\* XXX(G) is the model with built-in GPIB, the function is the same as standard model, please check with ITECH for availability

Model	Voltage Range	Resistance Range
IT5101 (G)	-300V~+300V	$3\text{m}\Omega\sim 3000\Omega$
IT5101H (G)	-1000V~+1000V	$3\text{m}\Omega\sim 3000\Omega$
IT5101E (G)	-300V~+300V	$300\text{m}\Omega\sim 3\Omega$

## 2.3 Front Panel Introduction

Schematic Diagram of Front Panel of IT5101 series internal resistance tester is as follow.

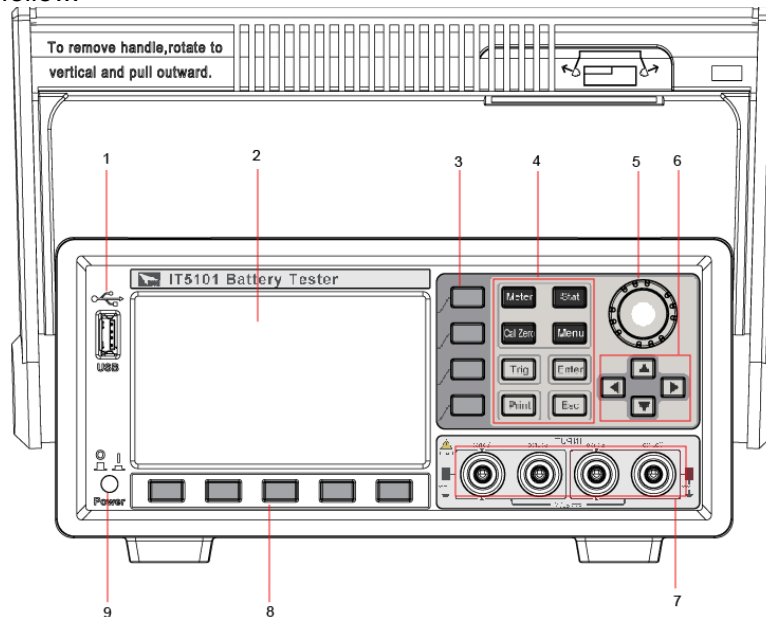



- 1 USB Interface
- 2 Display
- 3 Menu Keys
- 4 Function Keys
- 5 Setting knob

- 6 Arrow keys
- 7 Source terminals & Sense terminals
- 8 Menu Keys
- 9 Power Key

## 2.4 Introduction to keyboard







The functions of keys on the front panel of the IT5101 series internal resistance tester are shown in the following table.

Key tag	Name and function
<b>Meter</b>	Basic Measurement key When this key is pressed, the measurement value of voltage and resistance will be displayed, and also displayed the config menu of measurement.
<b>Stat</b>	Statistics key. When this key is pressed, the statistic parameters (average, standard deviation) of measurement data will be displayed.
<b>Cal Zero</b>	Zero key. When this key is pressed, zeroing information will be displayed.
<b>Menu</b>	Menu key, used for setting relevant measurement parameters.
<b>Trig</b>	Used for manual trigger.
<b>Enter</b>	Enter key, used for confirming and saving the settings.
<b>Print</b>	Used for saving screen images
<b>Esc</b>	Cancel/Return key

Key tag	Name and function
	Up/Down key and Left/Right key
	Soft keys for corresponding screen menu operations
	Rotary knob: used for setting the value indicated by the cursor, selecting the voltage and resistance range, adjusting the waveform, etc.

## 2.5 Screen Indicator Lamps Description

IT5101 series internal resistance tester screen indicator lamps description as follows:

Flag	Function Description
	Mx+B statistic function ON
	Insert USB peripheral device
	Key lock. Press this key to disable all the keys except Esc; press Esc key again for 5s to unlock all other keys.
	Compare function ON.
	Average function ON.
	Statistic function ON.
	Used for turning on remote control

## 2.6 Rear Panel Introduction

Schematic diagram of rear panel of IT5101 series internal resistance tester is as follow.

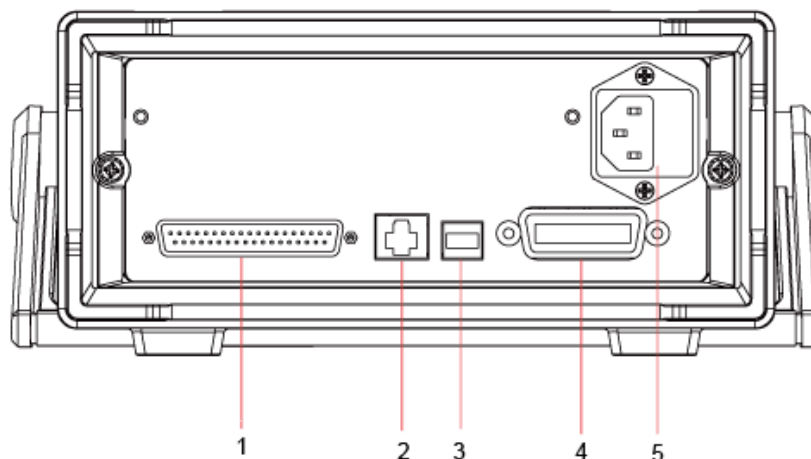

1 System I/O Interface  
2 LAN Interface  
3 USB Interface

4 GPIB Interface (Only for IT5100G series)  
5 AC Power Input

## 2.7 Power-on Selftest

A successful selftest indicates that the purchased power product meets delivery standards and is available for normal usage.

Before operation, please confirm that you have fully understood the safety instructions.

### WARNING

- To avoid burning out, be sure to confirm that power voltage matches with supply voltage.
- The IT5101 supports 110V/220VAC input and no need to switch.
- Maximum voltage measurement range refer to specification; maximum voltage between positive and negative and ground can not exceed voltage range; otherwise, the equipment will be burnt!
- Be sure to connect the main power socket to the power outlet of protective grounding. Do not use terminal board without protective grounding. Before operation, be sure that the internal resistance tester is well grounded.

### Power Switch Introduction

User can press the power switch of IT5101 series internal resistance tester directly to turn on or turn off the instrument.

The status of Power switch is as follows.

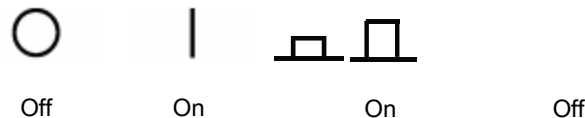

### Selftest steps

The normal power-on process of the IT5101 series internal resistance tester are as follows:

1. Properly connect the power cord and press **[Power]** to power on the instrument.
2. The internal resistance tester will take self-test and the instrument will complete inter-CPU communication test and reading and writing test of memory.
3. After initialization, the LCD screen displays the following information.

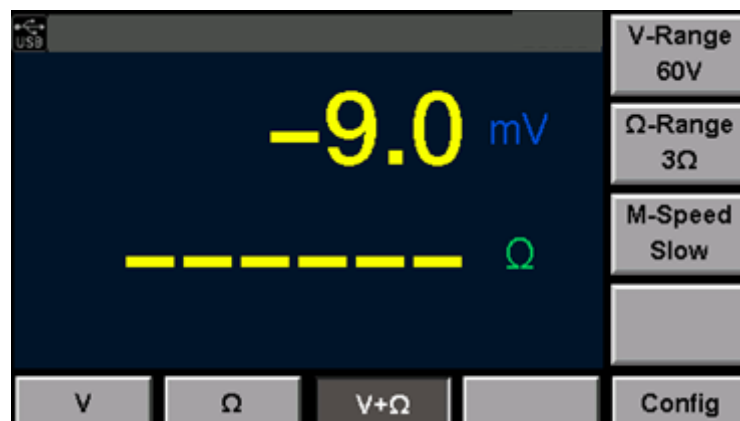

## Exception handling

If the internal resistance tester cannot start normally, please check as below steps.

1. Check whether the power cord is correctly connected and confirm whether the internal resistance tester is powered.

Correct wiring of power cord = > 2

Incorrect wiring of power cord = > Re-connect the power cord and check whether the exception is removed.

2. Check whether the power in On. Power key is under “I” On status.

Yes = > 3

No = > Please check the Power key to start power and check whether the exception is removed.

3. Check whether the fuse of internal resistance tester is burned out.

If yes, change fuse. Detailed steps:

- i. First pull out the power cord, and then take out the fuse block from the power cord jack with a small screwdriver, as shown below:

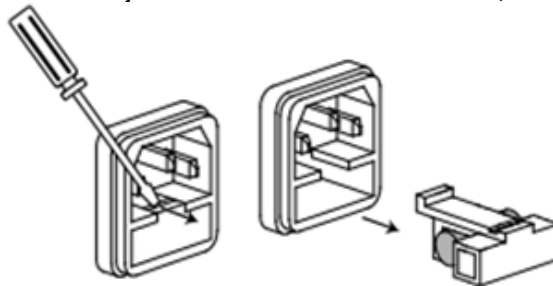

- ii. Have a visual inspection of the fuse to see whether it is burnt out; if yes, replace it with another fuse of the same specification.
- iii. After replacement, mount the fuse block to the original position, as illustrated below:

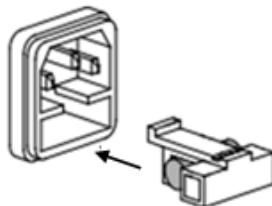

## Chapter3 Function and Features

This chapter describes in detail the use of the front-panel keys and shows how they are used to accomplish internal resistance tester operation.

### 3.1 Range Setting

IT5101 Series internal resistance tester provides several ranges for measuring voltage and internal resistance. If voltage/internal resistance scope of DUT is known, appropriate selection of range will improve measurement accuracy.

- Voltage ranges of IT5101 Model: 6V, 60V and 300V; resistance ranges: 3m $\Omega$ , 30m $\Omega$ , 300m $\Omega$ , 3 $\Omega$ , 30 $\Omega$ , 300 $\Omega$  and 3,000 $\Omega$ . If voltage/internal resistance scope is unknown, select Auto and the instrument will select appropriate range automatically.
- Voltage ranges of IT5101E Model: 6V, 60V and 300V; resistance ranges: 300m $\Omega$  and 3 $\Omega$ . If voltage/internal resistance scope is unknown, select Auto and the instrument will select appropriate range automatically.
- Voltage ranges of IT5101H Model: 10V, 100V and 1000V; resistance ranges: 3M $\omega$ , 30m $\Omega$ , 300m $\Omega$ , 3 $\Omega$ , 30 $\Omega$ , 300 $\Omega$  and 3,000 $\Omega$ . If voltage/internal resistance scope is unknown, select Auto and the instrument will select appropriate range automatically.

You can directly select the measurement range on current Measurement interface. Detailed operations are as follows:

1. Press [**Meter**] key. Display current measurement status.
2. Press corresponding soft key of V/ $\Omega$ /V+ $\Omega$  to select current measurement situation.
3. Based on different situations, press corresponding soft key of “**V-Range**” and “ **$\Omega$ -Range**” to select appropriate measure range.

Voltage range (V-Range) setting diagram of IT5101 Model is as shown below.



Resistance range ( **$\Omega$ -Range**) setting diagram of IT5101 Model is as shown below.



### 3.2 Sampling Rate Setting

When measuring voltage or internal resistance with the IT5101 internal resistance tester, the user can directly select a sampling speed from four gears: Slow, Med, Fast and EX. Fast on the current Measurement interface. Detailed operation steps are shown below:

1. Press [Meter] key. Display current measurement status.
2. Press corresponding soft key of V/Ω/V+Ω to select current measurement situation.
3. Under different situations, select appropriate sampling speed by pressing corresponding soft key of “M-Speed”.



### 3.3 System Menu

Menu function include system setup and system configuration, Press “MENU” on the front panel to set the system menu. You can set the following menu items.

Menu	System Menu	
	<b>Sys Info</b>	<b>System information</b>
	Model	Product Model
	Version	software Version



SN		Series Number
Cal Info		Calibration information
MAC Address		Network hardware address
<b>Sys Set</b>		<b>System Setting</b>
Beeper		Setting the buzzer function
Brightness		Setting the screen brightness.
ExtendRange		The function for IT5101E only, used to extend the resistance range.
<b>Config</b>		<b>System Configuration</b>
Filter Freq		Setting the filter frequency
Alarm Set		Setting the mode of alarm
Err Out		Setting Err output mode
Prevent Fire		The function for IT5101H only, used to switch the prevent fire enable and disable. On: enable the prevent fire, and the voltage range changed to 12V~1000V. Off: disable the prevent fire, and the voltage range limited to 0V~300V, if exceed 300V, the prevent fire switch to on automatically.
EOM Mode		Setting th EOM signal
Pulse Time		Setting the pulse time. It is effective when "EOM Mode" set to "Pulse"
<b>Comm Set</b>		<b>Communication configuration</b>
USB	Type B Connect	Select the USB communication interface.
VCP	Virtual COM Port	Virtual COM Port, it need to install the driver for VCP.
GPIB	Address	The address can be set within 1-31
LAN	IP Mode	IP mode: MANU/DHCP
	Port Set	Setting port
	IP Address	Setting IP address
	IP Mask	Setting IP mask
	Gate Way	Setting gateway
<b>Reset</b>		<b>Reset system</b>
SetReset		Reset the configuration of system
SysReset		Reset all of system configuration

Press **[Menu]** key. The system, by default, displays System Information; press the corresponding soft key of **[Sys Set]** to enter System Parameter Setting page for setting the configurations below. (The schematic diagram takes IT5101 Model as an example)

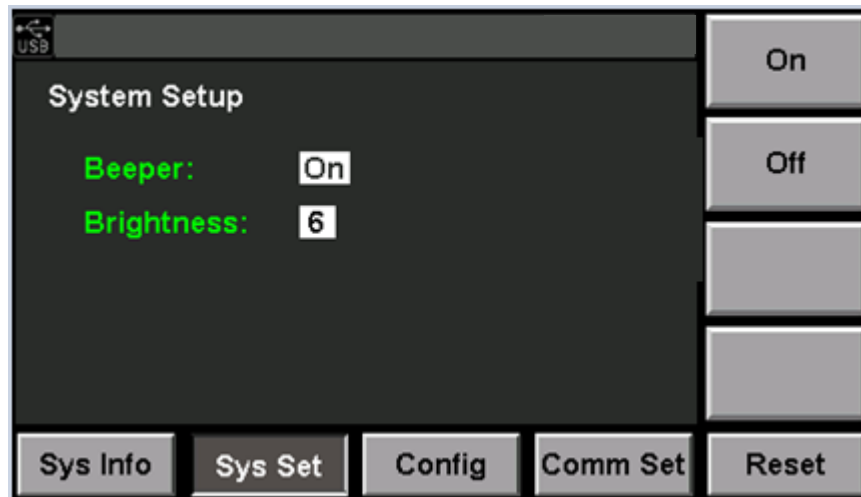

### Key Sound Set (>Beeper)

This item can set the buzzer state. **On** option indicates that when you push buttons, the buzzer will sound. **OFF** option indicates that the buzzer function is disabled. Factory default is **On** option.

### Adjust Screen Brightness

The user can adjust current screen brightness as required. Select "Sys Set" in the menu and set Brightness value from 0-9, representing different brightness. The larger is the value, the brighter is the screen.

### Extend Range (special for IT5101E)

The internal resistance tester of IT5101E Model has only two small ranges: 3 $\Omega$  and 300m $\Omega$ . However, the user can extend the range to make it consistent with that of IT5101 Model. To extend range, select "Sys Set" in the menu and input key in "Extend Range" setting item. Press [Enter] to extend range.

Range Extend is controlled by a key. To extend range, the user must ask for the key from ITECH.

## 3.4 Reset System

In Menu interface, press corresponding soft key of Reset for system reset. The user can select reset range and then reset the system:

- SysReset: system reset.

The system will reset the parameters below to ex-factory setting.

Parameters	Default setting
Measurement mode	V+R
V-Range	IT5101/IT5101E: 300V IT5101H: 1000V
$\Omega$ -Range	IT5101/IT5101H: 3m $\Omega$ IT5101E: Auto
M-Speed	Slow
Sys Set	Beeper: On

Parameters	Default setting
	Brightness: 6
Comm Set	USB
Delay (Cal zero)	0s
Filter Freq	50HZ
Alarm Set	Display
Err Out	ASync
EOM Mode	Hold
Compare	Off
Mx+B	Off
Trig Source	Auto
Trig delay	Off
Delay Time(Trig)	0s
Average	Off
Statistics	Off

SetReset: Configuration reset.

Parameters	Default setting
Measurement mode	V+R
V-Range	IT5101/IT5101E: 300V IT5101H: 1000V
$\Omega$ -Range	IT5101/IT5101H: 3m $\Omega$ IT5101E: Auto
M-Speed	Slow
Compare	Off
Mx+B	Off
Trig Source	Auto
Trig delay	Off
Average	Off
Statistics	Off

### 3.5 Frequency Filter Setting

To remove noise, the user needs to set frequency for the internal resistance tester. This item in the Menu is used to set frequency value of the frequency filter. The user can set the frequency value for the frequency filter to 50Hz or 60Hz. This frequency must be consistent with the internal resistance tester frequency. Incorrect internal resistance tester frequency may lead to unstable measurement value.

1. Press **[Menu]** key. Display current measurement status.

2. Press corresponding soft key of [**Config**] to set filter frequency, alarm, Err out and EOM mode.
3. Press Up/down key to select “**Filter Freq**” and select corresponding frequency value. The frequency value should be consistent with AC input frequency.
4. Press Up/down key to select configuration item to be set and press corresponding soft key for setting. Press [**Enter**] to confirm the set values. Otherwise, the set value will not be effective.

After setting, press [**Esc**] to return to Measurement interface; when you directly press [**Esc**] to return but fail to press the [**Enter**] key for confirmation, the setting fails.

## 3.6 Alarm Mode Setting

This item is used to set alarm mode of Compare function:

- Display means to display alarm where the Meter Interface will display comparison result, and not gives beep alarm;
- Beeper means to sound alarm where the Meter interface only gives beep sound but not displays comparison results;
- All means display alarm + sound alarm.

When All is selected, VFD displays comparison results (In, Low or High), and gives sound.

1. Press [**Menu**] key to enter Menu Setting page.
2. Press corresponding soft key of [**Config**] to set filter frequency, alarm, Err out and EOM mode.
3. Press Up/down key to select “**Alarm Set**” and select corresponding alarm mode of comparison results.
4. Press Up/down key to select configuration item to be set and press corresponding soft key for setting. Press [**Enter**] to confirm the set values. Otherwise, the setting will not be effective.

## 3.7 Compare Function

The IT5101 Series internal resistance tester provides Compare function. The user can turn on this function and set comparison range or basis, and display comparison results during measurement. This will help the user to detect the specifications of products in batch. The Compare function of Series IT5101 internal resistance tester is divided into Absolute Comparison and Relative Comparison.



### Notes

When voltage or resistance range is in “Auto” status, Compare function is disabled and the “Compare” interface under “Config” interface cannot be opened.

- Absolute Comparison allows the user to set upper and lower limits of the voltage and resistance. The instrument will check whether the measured value is within the preset range. The comparative results will either be displayed on the screen in the form of alarm information or be given by giving a beeper alarm. There are three alarm types: screen display + beeper, only screen display or only beeper.
- Relative Comparison allows the user to set basic value and relative percent of voltage and resistance. For example, if basic value and percent are set to 100V and 30% respectively, it indicates that if the measured value is 30%

higher/lower than the basic value, the system will alarm.

## Setting Method

1. Press **[Meter]** key. Display Measurement page.  
In the Meter interface, select required Measurement mode: V/R/V+R, and select appropriate measurement range.
2. Press corresponding soft key of **[Config]** and select related measurement configurations.
3. By default, the system displays configuration items related to Compare function, as shown below.

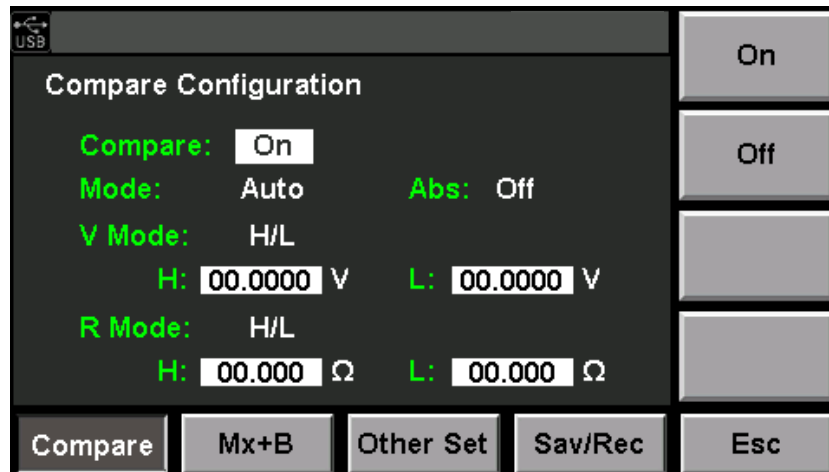

- Compare: On or Off, used for turning on or off Compare function.
  - Mode: Compare mode. It is divided into Manual (output comparer results only when EXT I/O MANU input is ON) and Auto (always output comparer results). Default mode: Auto.
  - Abs: during judgment of comparer, read absolute value of voltage measurement. Even in reversed polarity of battery, comparison still can be realized based on absolute value.
  - V Mode: set voltage compare mode: Absolute (H/L) and Relative (Ref%).
  - R Mode: set resistance compare mode: Absolute (H/L) and Relative (Ref%).
  - H: set upper limit of voltage or resistance.
  - L: set lower limit of voltage or resistance.
  - R: set basic value in comparison.
  - %: set percent of voltage/resistance value in comparison.
4. Press Up/down key to select configuration item to be set and press corresponding soft key for setting. Set values through knob. Press **[Enter]** to confirm the set values. Otherwise, the setting will not be effective.  
After setting, press **[Esc]** to return to Measurement interface; when you directly press **[Esc]** to return but fail to press the **[Enter]** key for confirmation, the setting fails.
  5. After Compare function is on, if Alarm mode is set to Display, the Meter interface will display comparison results. If set to Beeper, the instrument will give beep alarm. Meter interface of display mode is as follows:

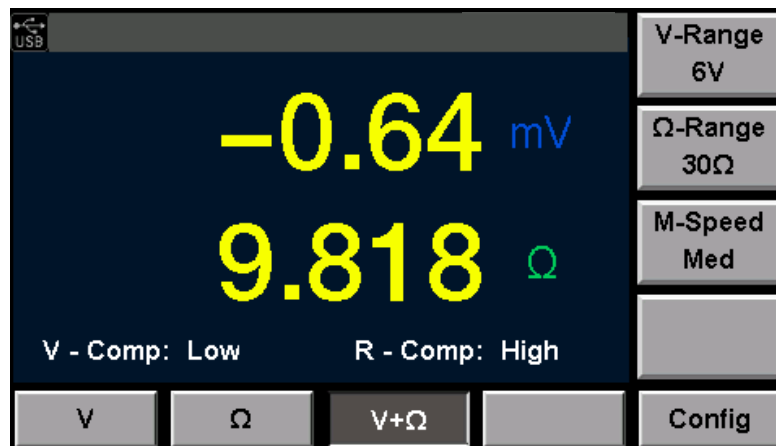

- V-Comp: voltage compare result: Low (lower than compare range)/High (higher than compare range)/In (within compare range)
- R-Comp: resistance compare result: Low (lower than compare range)/High (higher than compare range)/In (within compare range)

### 3.8 Calculate Function

The IT5101 Series internal resistance tester provides Calculate function, and is applied for instrument calibration or linear amplification of measured data. Suppose that the current measured voltage is  $x$ , the value after linear amplification is  $M \cdot x + B$ , where  $M$  and  $B$  are set values.

In general, Calculate function is used to calculate other physical values related to voltage and resistance. Suppose that there is a linear relationship between resistance and temperature:  $T = M \cdot R + B$ , where  $T$  means temperature,  $R$  means resistance, and  $M$  and  $B$  are set coefficients, through measurement of resistance value, you can display temperature result.

Set amplification factor and offset value following the steps below:

1. Press **[Meter]** key. Display current measurement status.
2. Press corresponding soft key of **[Config]** and select corresponding configuration items related to current measurement.
3. Press corresponding soft key of **[Mx+B]** for related settings of Calculate function. As shown below.

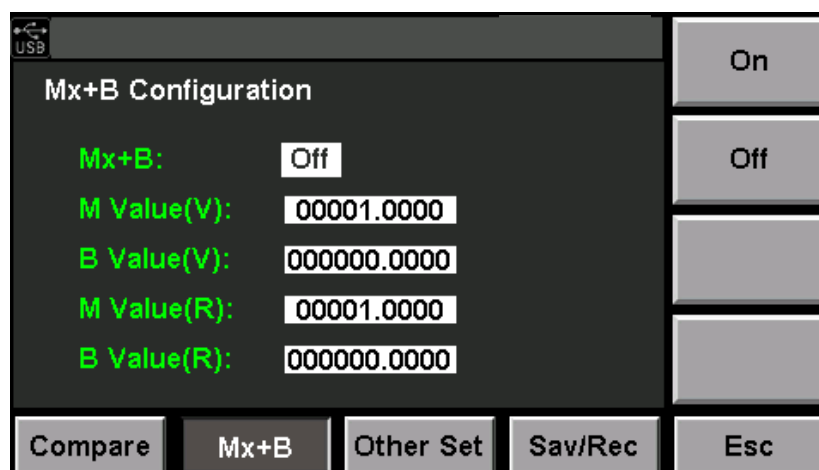

- Mx+B: On/Off, used to set on/off of the Calculate function.

- M Value(V): set multiple of voltage linear amplification. Setting range: -1,000.0000~1,000.0000.
  - B Value(V): set offset of voltage linear amplification. Setting range: -10,000.00000~10,000.0000.
  - M Value(V): set multiple of resistance linear amplification. Setting range: -1,000.0000~1,000.0000.
  - B Value(V): set offset of resistance linear amplification. Setting range: -10,000.00000~10,000.0000.
4. Press Up/down key to select configuration item to be set and press corresponding soft key for setting. Set values through knob. Press **[Enter]** to confirm the set values. Otherwise, the setting will not be effective.

After setting, press **[Esc]** to return to Measurement interface; when you directly press **[Esc]** to return but fail to press the **[Enter]** key for confirmation, the setting fails.

### 3.9 Average Function Setting

To make measured value more accurate, the instrument provides Average function, where the user can set total count of average as required. For example, if the Count is set to 5, the measured result of each time will be the average from 5 samplings.

1. Press **[Meter]** key. Display current measurement status.
2. Press corresponding soft key of **[Config]** and select corresponding configuration items related to current measurement.
3. Press corresponding soft key of **[Other Set]** to set Filter, Average, Trigger functions and Statistics On/Off.
4. Press Up/down key to select “Average” and select “On” to turn on Average. Set total count of samplings for Average. As shown below.

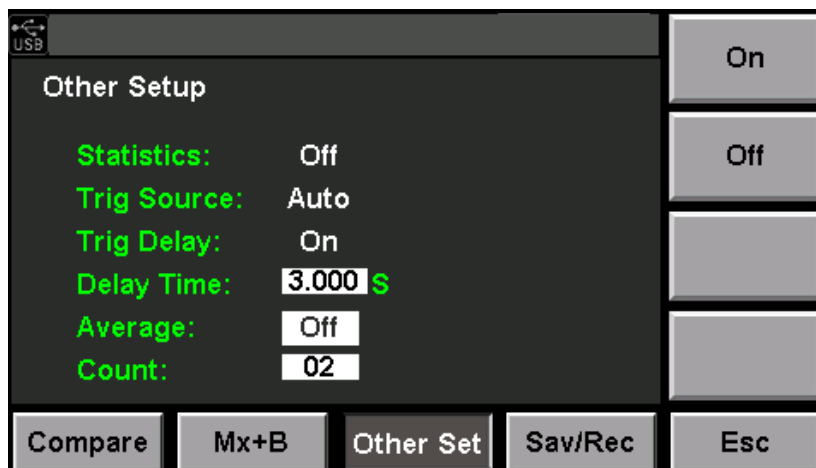

- Average: On/Off, used to turn on or off Average function.
  - Count: set total count of samplings for Average. Setting range: 2~16.
5. Press Up/down key to select configuration item to be set and press corresponding soft key for setting. Set values through knob. Press **[Enter]** to confirm the set values. Otherwise, the setting will not be effective.

After setting, press **[Esc]** to return to Measurement interface; when you directly press **[Esc]** to return but fail to press the **[Enter]** key for confirmation, the setting fails.

### 3.10 Trigger Function Setting

Trigger Function Setting means to set the signal trigger mode for each measurement. The instrument will sample and measure once after each trigger. The user can set different trigger modes as required, i.e., triggering source setting. Under initial status of IT5101, the trigger source is Auto.

#### Trigger Source Setting

The user can select different trigger sources and set trigger waiting time. Select “Trig Source” in the menu, and select corresponding soft key of trigger source as required. IT5101 internal resistance tester has two trigger sources:

- Auto: the instrument will automatically generate trigger for auto measurement.
- Ext: external trigger, including keyboard [Trig], bus command trigger or external trigger via the TRIG terminal input signal of EXT I/O port; when TRIG signal is triggered once, the system will take 1 trigger and measure once.

#### Trigger Delay Setting

The user can turn on/off Trigger Delay function and set the delay time from the time to input trigger signal to the time to start measure as required. Through this function, the user can start measurement immediately after connection of DUT or after measured value gets stable. Select this setting item and rotate the knob to set specific time value.

#### Setting Step

1. Press **[Meter]** key. Display current measurement status.
2. Press corresponding soft key of **[Config]** and select corresponding configuration items related to current measurement.
3. Press corresponding soft key of **[Other Set]** to set Filter, Average, Trigger functions and Statistics On/Off.
4. Press Up/down key to select “**Trig Source**” and select corresponding trigger source. Press **[Enter]** for confirmation.
5. Press Down key to select “**Trig Delay**” and set Delay Function On/off. Select On and press **[Enter]** for confirmation.
6. Press Down key to select “**Delay Time**” and set delay time through knob. Press **[Enter]** for confirmation.





- After setting, press **[Esc]** to return to Measurement interface; when you directly press **[Esc]** to return but fail to press the **[Enter]** key for confirmation, the setting fails.

### 3.11 Statistics On/Off Setting

In measurement, the user can conveniently turn on Statistic function in Measurement Configuration menu. When this function is enabled, each trigger of measurement will be recorded as one piece of statistic data. For detailed statistic information, refer to Statistic Function. When the trigger source is set at Auto (auto measurement by the instrument) auto Statistic function will not be enabled so that the user needs to press **[Trig]** key to trigger Statistic measurement. If Statistic function is off, even if the **[Start]** is pressed, statistics still fails.

- Press **[Meter]** key. Display current measurement status.
- Press corresponding soft key of **[Config]** and select corresponding configuration items related to current measurement.
- Press corresponding soft key of **[Other Set]** to set Average and Trigger functions and Statistics On/Off.
- Press Up/down key to select "**Statistics**" to turn on/off this function.



- Press **[Enter]** to confirm the set values. Otherwise, the setting will not be effective.
- After setting, press **[Esc]** to return to Measurement interface; when you directly press **[Esc]** to return but fail to press the **[Enter]** key for confirmation, the setting fails.

### 3.12 Save/Recall Function

The user can save current measurement conditions in nonvolatile storage space and recall these conditions from saving address. In IT5101 internal resistance tester, at maximum of 127 groups of measurement conditions can be saved, including:

Measurement mode	Trig Source
V-Range&Ω-Range	Trig delay
M-Speed	Average
Filter Freq	Statistics

Compare

Mx+B

1. Press [**Meter**] key. Display current measurement status.
2. Press corresponding soft key of [**Config**] and select corresponding configuration items related to current measurement.
3. Press corresponding soft key of [**Sav/Rec**] to save or recall measurement conditions.
4. In "Address", input address for saving or recalling. Setting range is 1-127.
5. Press corresponding soft key of [**Save**] or [**Recall**] for saving or recalling.



### 3.13 Screen Capture Function

The internal resistance tester has the function of screen capture. Insert the USB disk to USB interface on front panel, When [**Print**] on the front panel is pressed, the internal resistance tester will capture the present screen and save it into the external storage device.

### 3.14 Statistics Function

The Statistics function enables batch record, statistics and analysis of batch measurement results of battery. In Excel table, 1,000 pcs of measurement data can be recorded. In IT5101 internal resistance tester, the user can take statistics and analysis for measurement results, and calculate and display such data as average, maximum value, minimum value, parent standard deviation, sampling standard deviation and process capacity index.

The calculation formulas are as follows:

parameter	calculation formulas
Mean( $\bar{x}$ )	$\bar{x} = \frac{\sum x}{n}$
Standard deviation of population ( $\sigma$ )	$\sigma_n = \sqrt{\frac{\sum x^2 - n\bar{x}^2}{n}}$
Stand deviation of sample (s)	$\sigma_{n-1} = \sqrt{\frac{\sum x^2 - n\bar{x}^2}{n-1}}$
Process capability index( dispersion)	$C_p = \frac{ Hi - Lo }{6\sigma_{n-1}}$

parameter	calculation formulas
Process capability index(bias)	$C_p K = \frac{ Hi - Lo  -  Hi + Lo - 2\bar{x} }{6\sigma_{n-1}}$

In these formulas, n represents the number of valid data samples. Hi and Lo are the upper and lower thresholds of the comparator.

The process capability indices represent the quality achievement capability created by a process, which is the breadth of the dispersion and bias of the process' quality. Generally, depending on the values of Cp and Cpk, process capability is evaluated as follows:

$C_p, C_p K > 1.33$	Process capability is ideal
$1.33 \geq C_p, C_p K > 1.00$	Process capability is adequate
$1.00 \geq C_p, C_p K$	Process capability is inadequate

### 3.14.1 View Statistic Results

Press **[Start]** key to enter Statistics page and view statistic information. In the Statistics page, the user can display all statistic information through scrolling display, or clear or save/recall all statistic information.

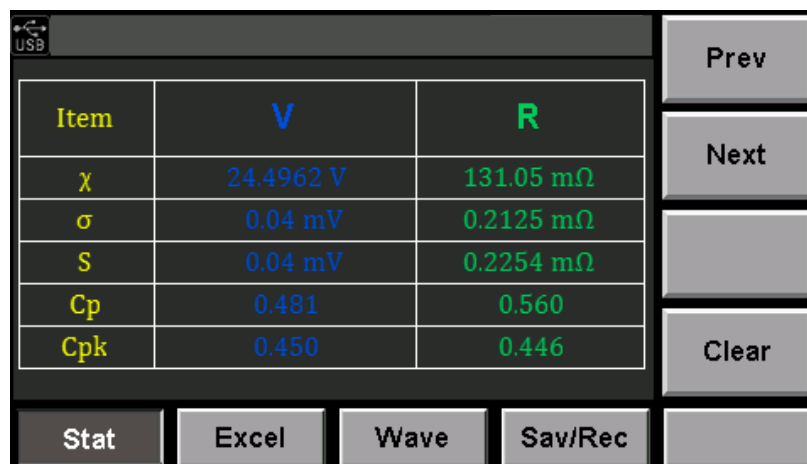

Item	V	R
χ	24.4962 V	131.05 mΩ
σ	0.04 mV	0.2125 mΩ
s	0.04 mV	0.2254 mΩ
Cp	0.481	0.560
Cpk	0.450	0.446

- Prev: page up.
- Next: page down.
- Clear: Clear statistic records. Press this soft key to clear records in Excel and wave display at the same time.

The user can view such statistic items as x, σ, s, Cp, Cpk, Max, Min, Index, etc.

### 3.14.2 Display List

In Statistic Function page, select corresponding soft key of **[Excel]** to enter Excel Table interface to view all current measurement data. The Excel displays measurement serial number, measurement value, comparison results and measurement time. In this interface, the user can select **[Home]**, **[Prev]**, **[Next]** and **[End]** to view all data through scrolling display. In Statistics Function, at maximum of 1,000 data can be recorded.

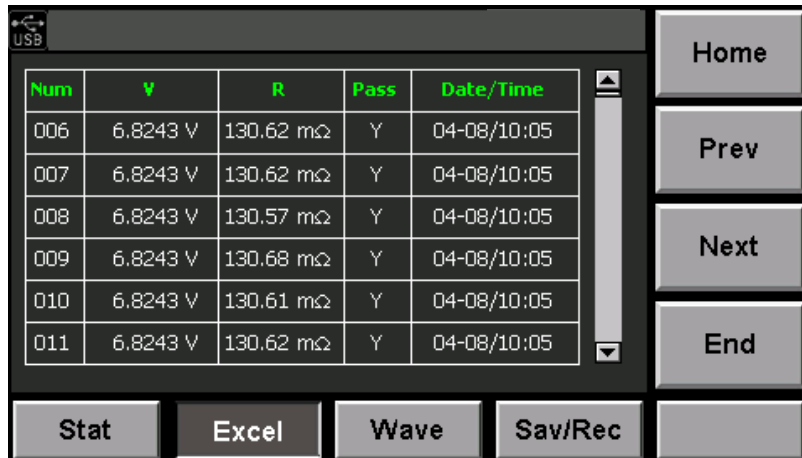

Num	V	R	Pass	Date/Time
006	6.8243 V	130.62 mΩ	Y	04-08/10:05
007	6.8243 V	130.62 mΩ	Y	04-08/10:05
008	6.8243 V	130.57 mΩ	Y	04-08/10:05
009	6.8243 V	130.68 mΩ	Y	04-08/10:05
010	6.8243 V	130.61 mΩ	Y	04-08/10:05
011	6.8243 V	130.62 mΩ	Y	04-08/10:05

Buttons: Home, Prev, Next, End, Stat, Excel, Wave, Sav/Rec

**Notes**

Pass means to compare results; Y means that comparison is passed; N means that comparison is not passed. When Compare function is Off and the "Pass" in Statistics information is also under Y status, for accurate comparison results, please turn on Compare function at first and set related parameters. If the measured value exceeds range, the N status will be displayed in regardless of whether Compare function is on or off.

### 3.14.3 Display Normal Distribution Plot

In Statistic Function page, select corresponding soft key of **[Wave]** to enter Normal Distribution Plot Display page to view normal distribution of voltage and resistance. The user can increase or decrease wave display amplification through the knob.

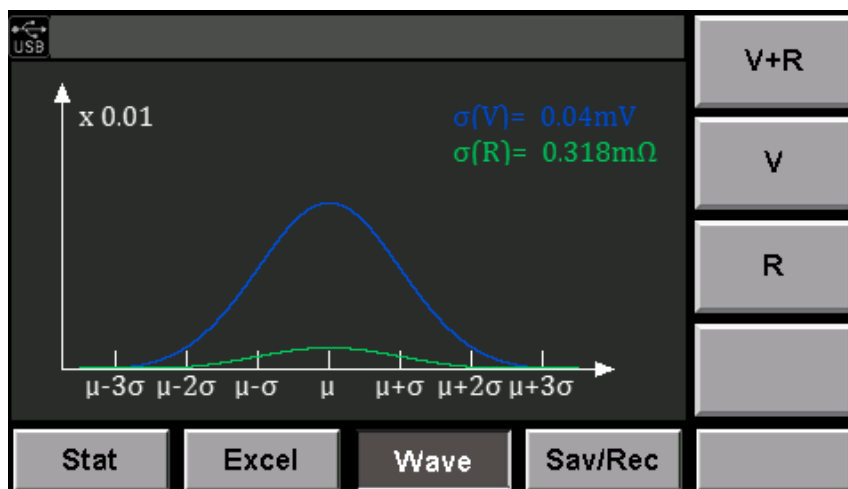

### 3.14.4 Save/Recall Measurement Data

In Statistic Function page, select corresponding soft key of **[Sav/Rec]** to enter Save interface to save the data to USB or to enter Recall interface to recall data saved in USB. Before saving/recalling data, please insert USB.



- Save Data

In Save/Recall page under Statistic Function, measurement data are saved in USB in CSV format. The file is named after the current saving time. Press corresponding soft key of [Save] to save Excel data to USB. CSV file contents are as shown below.

Num	Voltage	Resistance	Voltage State	Resistance State	Date/Time
0	-0.03036	100000000000.	0	3	02-13/02:09
1	-0.03045	100000000000.	0	3	02-13/02:09
2	-0.03053	100000000000.	0	3	02-13/02:09
3	-0.03034	100000000000.	0	3	02-13/02:10
4	-0.03059	100000000000.	0	3	02-13/02:10
5	-0.03054	100000000000.	0	3	02-13/02:10
6	-0.03021	100000000000.	0	3	02-13/02:10

- Recall Data

Insert USB with files to be recalled inside. The instrument will search for the data file inside and display file list, as shown above. Press Down key to select required file name and press [Recall] key to recall data records in the USB.

## 3.15 Zero-Adjust Function

Execute zero adjustment before measuring to nullify any residual offset voltage from the instrument or measurement environment. Measurement accuracy specifications are applicable after zero adjustment.

Zero adjustment is a function which adjusts the zero point by deducting the residual value obtained during 0Ω measurement. For this reason, zero adjustment must be performed when connection is made to 0Ω. However, connecting a sample with no resistance is difficult and therefore is not practical.

In this respect, when performing the actual zero adjustment, create a pseudo connection to 0Ω and the adjust the zero point.

### Wiring principle for Zero-Adjustment

The voltage between Sense(Red) and Sense(Black) becomes 0V according to the Ohm's Law of  $E=I \cdot R$ . In other words, if you set the voltage between Sense(Red) and Sense(Black) to 0V, this gives you the same state of 0Ω connection.

Before executing zero adjustment, connect the test leads (probes) as follows:

1. Connect Sense (Red) to Sense (Black).

2. Connect Source (Red) to Source (Black).
3. Connect Sense (Black) and Source(Black).

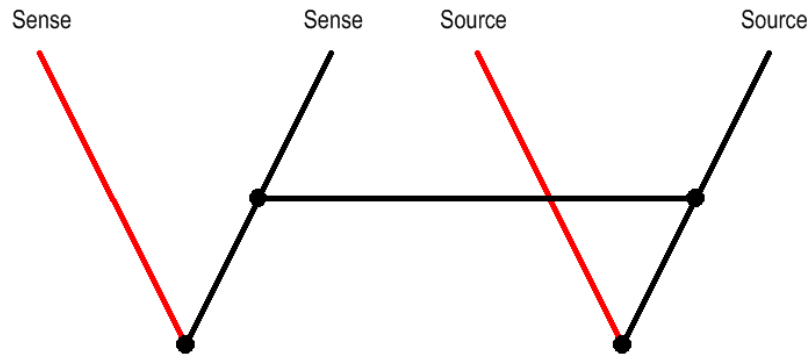

Note

The detailed information for test leads probes, please refer to the test lines introduction.

Since the amount of zero adjustment varies with the position and state of the measurement leads (probes) (i.e., their length, shape, position, etc.), the measurement leads must be positioned in the actual measurement state before performing zero adjustment.

### Wiring Method for Zero-Adjustment

When execute zero adjustment, the four terminal short connection of test lines provided by ITECH with the help of Zero adjustment board

### Executing Zero-Adjustment

1. Connecting the test line probes to zero adjustment board correctly.
2. Press [**Cal Zero**] in front panel and enter the Calibration zero page.
3. In calibration zero page, user can set the delay time and delay execute the zero adjustment, the delay time can set from 0 to 9 second.



4. Press [Start] softkey and start zero adjustment.

### 3.16 External Control(EXT I/O)

The EXT I/O interface in IT5101 rear panel is used to external output terminals and external control terminals. Please pay attention to this alarm information before connecting

#### WARNING

To avoid electric shock or damage to the instrument, always observe the following precautions when connecting to the EXT/ I/O terminals.

- Always turn off the power to the instrument and to any devices to be connected before making connections.
- During operation, a wire becoming dislocated and contacting another conductive object can be serious hazard. Make sure that connections are secure and use screws to secure the external connectors.
- Ensure that devices and systems to be connected to the EXT I/O terminals are properly isolated.

#### CAUTION

- Do not apply voltage or current to the EXT I/O terminals that exceeds their ratings.
- When driving relays, be sure to install diodes to absorb counter-electromotive force.
- Be carefull not to short-circuit ISO\_5V to ISO\_COM.

#### Pin definition

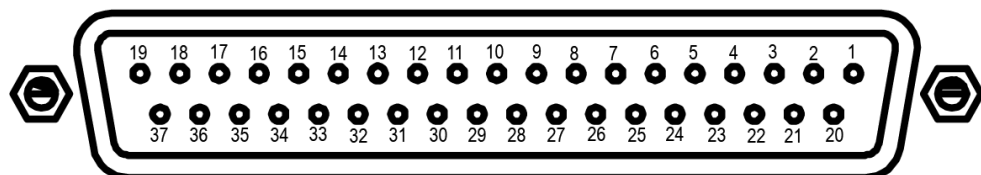

Pin	Signal name	I/O	Function	Pin	Signal name	I/O	Function
1	TRIG	IN	External trigger	20	OADJ	IN	Zero adjustments
2	(Reserved)	IN	-	21	(Reserved)	IN	-
3	(Reserved)	IN	-	22	LOAD0	IN	Load no. bit 0
4	LOAD1	IN	Load no. bit1	23	LOAD2	IN	Load no. bit 2
5	LOAD3	IN	Load no. bit 3	24	LOAD4	IN	Load no. bit 4
6	LOAD5	IN	Load no. bit 5	25	LOAD6	IN	Load no. bit 6
7	MANU	IN	Comparator manual control	26	(Reserved)	IN	-

Pin	Signal name	I/O	Function	Pin	Signal name	I/O	Function
8	ISO-5V	-	Isolated 5V power output	27	ISO-COM	-	Isolated common signal ground
9	ISO-COM	-	Isolated common signal ground	28	$\overline{\text{EOM}}$	OUT	End of measurement
10	$\overline{\text{ERR}}$	OUT	Measurement fault	29	$\overline{\text{INDEX}}$	OUT	Analog measurement finished
11	$\overline{\text{R\_HI}}$	OUT	Hi resistance judgment result	30	$\overline{\text{R\_IN}}$	OUT	IN resistance judgment result
12	$\overline{\text{R\_LO}}$	OUT	Lo resistance judgment result	31	$\overline{\text{V\_HI}}$	OUT	Hi voltage judgement result
13	$\overline{\text{V-IN}}$	OUT	IN voltage judgement result	32	$\overline{\text{V\_LO}}$	OUT	Lo voltage judgement result
14	(Reserved)	OUT	-	33	(Reserved)	OUT	-
15	(Reserved)	OUT	-	34	(Reserved)	OUT	-
16	(Reserved)	OUT	-	35	(Reserved)	OUT	-
17	(Reserved)	OUT	-	36	(Reserved)	OUT	-
18	$\overline{\text{PASS}}$	OUT	PASS judgement result	37	$\overline{\text{FAIL}}$	OUT	Judgement result Fail
19	(Reserved)	OUT	-	-			

## Signal Descriptions

The function description of external control terminals as follows:

- External trigger input ( $\overline{\text{TRIG}}$ )
- Select Panel No. to load ( $\overline{\text{LOAD0}} \sim \overline{\text{LOAD6}}$ )
- Zero-adjust signal input ( $\overline{\text{OAJ}}$ )
- Manual comparator judgment input ( $\overline{\text{MANU}}$ )

External output terminal functions:

- End-of-Conversion signal output ( $\overline{\text{EOM}}$ )
- Reference signal output ( $\overline{\text{INDEX}}$ )
- Measurement Fault signal output ( $\overline{\text{ERR}}$ )

Comparator decision signal output ( $\overline{\text{R-Hi}}$ 、 $\overline{\text{R-IN}}$ 、 $\overline{\text{R-Lo}}$ 、 $\overline{\text{V-Hi}}$ 、 $\overline{\text{V-IN}}$ 、 $\overline{\text{V-Lo}}$ 、 $\overline{\text{PASS}}$ 、 $\overline{\text{FAIL}}$ )

## $\overline{\text{TRIG}}$

When the external trigger, one measurement is taken each time the  $\overline{\text{TRIG}}$  signal transitions from High to Low.

This trigger signal is ignored when internal triggering is enabled.

Trigger functions are also available for statistical calculation, recording to memory and output of measured values (valid also with internal triggering)



## LOAD0 ~ LOAD6

Select a Panel No. to load and apply a TRIG signal to load the selected Panel No. and measure. LOAD0 is the LSB, and LOAD6 is the MSB.

When a TRIG signal is applied, if LOAD0 through LOAD6 are unchanged from the previous trigger event, panel settings are not loaded. In this case, using external triggering, one measurement is taken as usual when the TRIG signal is applied.

Panel No.	LOAD6	LOAD5	LOAD4	LOAD3	LOAD2	LOAD1	LOAD0
*	0	0	0	0	0	0	0
1	0	0	0	0	0	0	1
2	0	0	0	0	0	1	0
3	0	0	0	0	0	1	1
4	0	0	0	0	1	0	0
5	0	0	0	0	1	0	1
.....							
125	1	1	1	1	1	0	1
126	1	1	1	1	1	1	0
*	1	1	1	1	1	1	1

0: (HIGH: Open of from 5v to 24V) 1: (LOW: 0V~0.9V)

\* When a TRIG signal is applied with LOAD0 ~ LOAD6 set to all 1's or all 0's, no Panel Load occurs.

- At least 70 ms is required for the settings to change after executing a Panel Load (the actual time depends on the particular function, range and sampling rate).
- When set to external trigger mode, one measurement is taken upon load completion.

## OADJ

Zero adjustment executes once when the OADJ signal transitions from High to Low.

## MANU

When the MANU comparator mode is selected, comparator judgment is enabled while the MANU signal is Low.

## ERR

Indicates a measurement fault.

The Synchronous ERR output setting causes ERR output to be synchronous

with  $\overline{\text{EOM}}$  output, while with the Asynchronous  $\overline{\text{ERR}}$  output setting causes  $\overline{\text{ERR}}$  output to follow actual (asynchronous) contact of the probes with the test object.

## $\overline{\text{INDEX}}$

The  $\overline{\text{INDEX}}$  signal is output during the Trigger Wait, Delay, Self-Calibration and Calculation states.

This signal is not output while measuring the resistance of test objects. This signal transitions from Hi(Off) to Lo (On) to indicate that the test object can be removed.

## $\overline{\text{EOM}}$

This signal indicates the end of a measurement (End-Of-Conversion)

This signal indicates when comparator judgment results and  $\overline{\text{ERR}}$  output (when SYNC is enabled) are available.

## $\overline{\text{R-Hi}}$ 、 $\overline{\text{R-IN}}$ 、 $\overline{\text{R-Lo}}$ 、 $\overline{\text{V-Hi}}$ 、 $\overline{\text{V-IN}}$ 、 $\overline{\text{V-Lo}}$

These are the results of comparator decision.

## $\overline{\text{PASS}}$

This signal indicates when both resistance and voltage judgment results are IN ( $\Omega$ V mode).

It transitions to Low (ON) when both the resistance and voltage judgment results are IN.

In the  $\Omega$  and V modes, this signal is the same as R-IN and V-IN outputs, respectively.

## $\overline{\text{FAIL}}$

This signal transitions to Low (ON) when  $\overline{\text{PASS}}$  is Hi (OFF).



The Sense terminal and source terminal introduction for test line refer to test lines description.

- The  $\overline{\text{EOM}}$  and  $\overline{\text{INDEX}}$  signals are initialized HIGH(OFF) at power on.
- If it is not necessary to change the measurement conditions, set  $\overline{\text{LOAD0}}$  through  $\overline{\text{LOAD6}}$  to either Hi or Lo.
- To avoid erroneous comparator judgments, both the  $\overline{\text{PASS}}$  and  $\overline{\text{FAIL}}$  signals should be checked.

## 3.17 ERR Output

The ERR output signal indicates the occurrence of measurement fault conditions (such as open test leads, or a bad contact).

There are two ERR output methods.

- Synchronized with EOM Output (Sync)

Measurement faults detected while measuring (not while awaiting trigger or during delay or calculation intervals), are indicated by ERR output synchronous with EOM output(the end-of-measurement signal).

ERR output LOW (On): A measurement fault has prevented correct measurement.

ERR output HIGH (Off): Correct measurement obtained (OF or -OF: Out-of-range cases are included)

- Asynchronous with EOM Output (ASync)

Measurement faults (test lead connection conditions) are output in real time. The output is asynchronous with the  $\overline{\text{TRIG}}$  signal and EOM output.

ERR Output Low (On): Measurement fault condition(open test leads, or a bad contact)

ERR Output High (Off): Test lead connections are normal

## Setting Method

1. Press [**Menu**] and enter menu setting.
2. Press [**Sys Config**] and enter to system configuration page.
3. Press Up/Down direction keys and select “Err Out”, set the ERR output method.

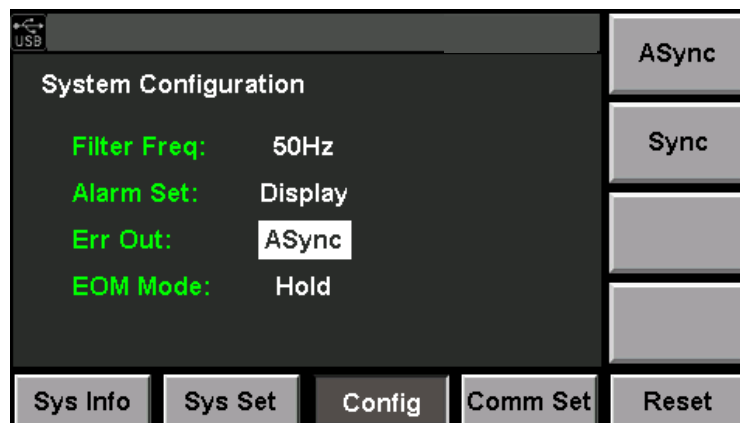

- ASync: Asynchronous with EOM Output
  - Sync: Synchronized with EOM Output
4. Press [**Enter**] to confirmed.

## 3.18 Setting EOM Signal

1. Press [**Menu**] and enter menu setting.
2. Press [**Sys Config**] and enter to system configuration page.
3. Press Up/Down direction keys and select “EOM Mode”, set the EOM output method.

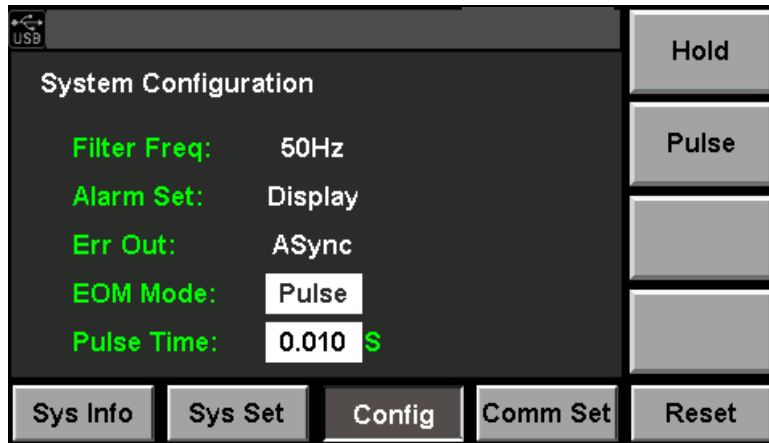

When EOM Mode set to “Pulse” output mode, it need to set pulse time. The unit is S. Otherwise, set to Hold mode, there is not this item setting.

### 3.19 Timing Chart

ERR output (ASync)

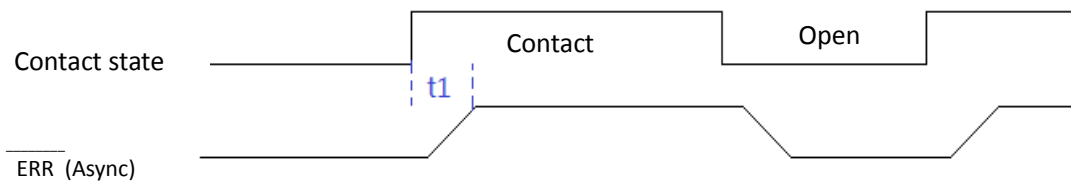

t1: ERR Output respond time  $\leq 5\text{ms}$

External Trigger Timing Chart

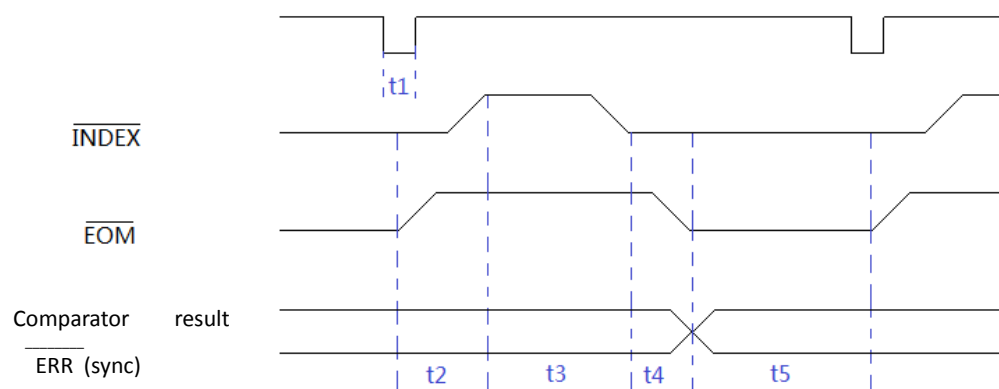

- t1: Trigger pulse width, 0.5ms or more
- t2: Delay Time, per setting
- t3: Measurement time, the value is Different according to the current sampling mode, detailed information refer to specification.
- t4: Calculation time, 0.18ms, deviation is  $\pm 0.02\text{ms}$
- t5: HOLD setting: Holds until the next trigger is detected, PULSE setting:

Remains only for the specified pulse width

### Auto Trigger Timing Chart

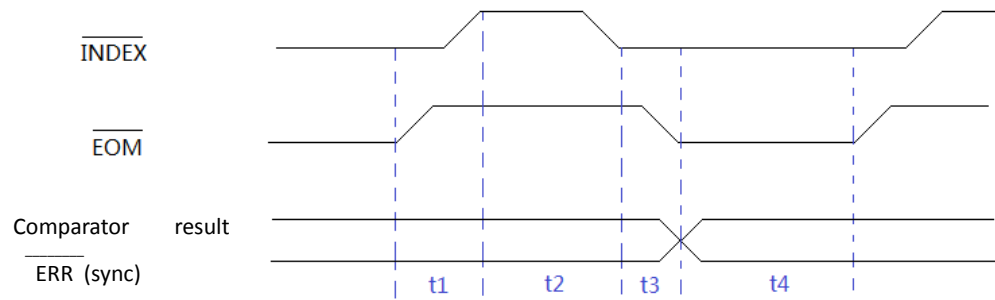

- t1: Delay Time, per setting
- t2: Measurement time, the value is Different according to the current sampling mode, detailed information refer to specification.
- t3: Calculation time, 0.18ms, deviation is  $\pm 0.02\text{ms}$
- t4: EOM output pulse width, HOLD setting: Holds until the next trigger is detected, PULSE setting: Remains only for the specified pulse width

## Chapter4 Routine Maintenance

This chapter describes the general maintenance items and methods for IT5100 internal resistance tester.

### 4.1 Self-test

IT5101 has the self-test function. For self-test details, refer to Chapter 2.7 "Power-on Self-test".

### 4.2 Routine Maintenance

This section introduces the basic maintenance involved in routine operation of the instrument, such as cleaning, self-repair, etc.

#### Cleaning

Wipe the machine with dry or slightly wet cloth. Do not wipe the inside of the machine without permission. Cut off the internal resistance tester before cleaning.

#### Reset

Factory settings of the system will be restored by implementing this operation:

1. Select **[Menu]** to enter the system menu.
2. Press the soft key corresponding to **[Reset]** to enter the system initialization interface, as shown below.

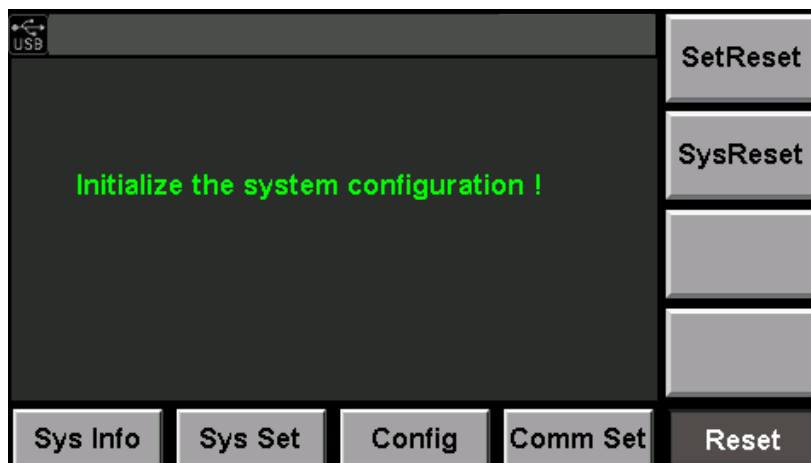

3. Press the **[SetReset]** or **[SysReset]** key and select the menu to be initialized. The detailed reset items please refer to 3.4 Reset System.
4. Finished and return to Meter page.

### 4.3 Contact ITECH Engineer

This section introduces the procedures for troubleshooting.

## Preparations before contact

In case of instrument failure, make the following preparations before returning the instrument to ITECH for repair or contacting the engineer.

1. Complete all inspections specified in “Self-check of Instrument Fault” and check whether the fault still occurs.
2. If the fault still occurs, carefully read the warranty service and restriction requirements in the foreword of the manual and confirm that your instrument meets the warranty service requirements.
3. To send the instrument back to the manufacturer for repair, see the requirements in 4.4 “Return for Repair”.

## Self-check of Instrument Fault

In case of instrument failure, please perform the following self-checks. If the instrument can be recovered by simple check, the cost and time can be saved. Before contacting the engineer of ITECH, please check the following items.

- Check whether the instrument is powered on.
- Check whether the instrument is started up normally.
- Check whether the fuse is in good condition.
- Check whether other connectors are in good condition, including cables, plugs, etc.
- Check whether the system configuration is correct in operation.
- Check whether the self-test is successfully and whether all specifications and performance meet the specified requirements.
- Check whether the instrument displays error information.
- Use other instruments instead of this instrument for confirmation.

## SN collection

ITECH will improve the product performance, availability and reliability from time to time. The service personnel of ITECH will record the changes of each instrument, and all the relevant information will be identified according to the SN. The SN will be used as the tracking ID of the instrument returned for repair.

To contact the engineer, the valid SN will be an effective guarantee for effective service and complete information. You can obtain the instrument SN in the following methods:

1. Press **[Menu]** to enter the system setting interface
2. The system will enter into “**Sys Info**” by default. If the system is displayed in other menus, press **[Sys Info]** to enter the “**System Information**” interface and view the product model, SN, software version, etc.

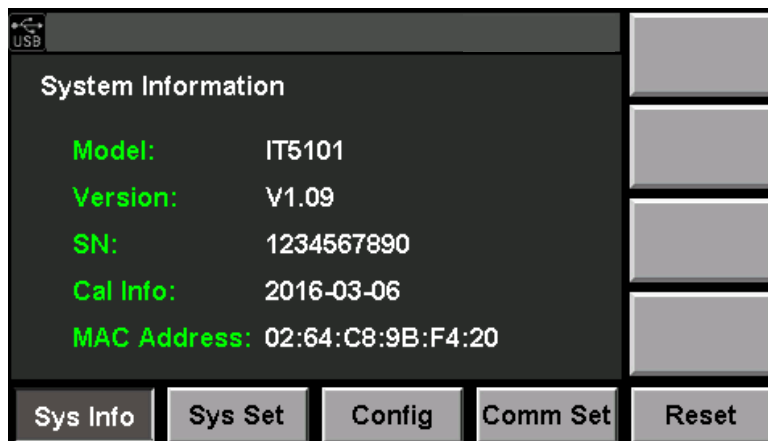

- Record the SN.

### Calibration interval

The calibration frequency recommended by ITECH for IT5101 internal resistance tester is once a year.

## 4.4 Return for Repair

Before returning the instrument for repair, please read the following requirements.

### Packaging

Refer to the following steps to package the instrument to be returned for repair. Pack the instrument to be repaired into the package used in delivery, including relevant accessories.

Provide the detailed problem description, such as copy of error information and any related problem information.

#### CAUTION

- The instrument may be damaged if the unspecified package is used for delivery. Use the special package for delivery, and pack the instrument according to the packaging standards of delivery.
- Do not use the styrene particle material of any shape as the package material, as the instrument cannot be well fixed in the package or prevented from shaking. In addition, the instrument may be damaged by static electricity generated by styrene particles or penetration of styrene particles into holes of the rear panel.

Read the requirements of transportation costs of warranty services in the foreword before delivery.



---

## Chapter5 Remote Control

---

Four standard interfaces are equipped for IT5101: GPIB, USB, LAN and RS232. Users can choose any of the USB, GPIB, RS232 and LAN to achieve the communication with PC.

### 5.1 USB Interface

Use a cable with two USB ports to connect internal resistance tester and PC. You can program through USB interface to achieve all functions of internal resistance tester.

The functions of USB488 interface are as follows:

- Interface is 488.2 USB488 interface
- Receive the following request: REN\_CONTROL, GO\_TO\_LOCAL, and LOCAL\_LOCKOUT
- When the interface receives MsgID = TRIGGER USBTMC command, it will transmit the TRIGGER command to the function layer

The functions of internal resistance tester's USB488 are as follows:

- receive all SCPI commands
- device is SR1 enabled
- device is RL1 enabled
- device is DT1 enabled

### 5.2 GPIB Interface(Only for IT5100G series)

Use a IEEE488 bus to connect GPIB interfaces of internal resistance tester and PC. Please ensure that the screws have been screwed down in order to have a full connection. Then press **[Menu]** to enter the system menu and press **[Comm Set]** to set the GPIB address. The address range of internal resistance tester is 0-99. After you set the address, please press **[Enter]** button to confirm. GPIB address is saved in nonvolatile memory.

### 5.3 LAN Interface

Press **[Menu]** > **[Comm Set]** button to enter the system set. Please select "LAN" in the Communication from System and then configure Gateway, IP, Mask and SocketPort in the LAN option.

Connect the LAN interface of internal resistance tester to the computer with a reticle (crossed). The gateway address should be consistent with that of the PC, and the IP address should be at the same network segment with the PC's IP address.

## Chapter6 Specification

This chapter will introduce the rated voltage, current, power and many other main parameters of IT5101 series.

### 6.1 Main technical parameters

Model		IT5101		
<b>Measurement Range</b>				
<b>Voltage</b>	Range	-6V~+6V	-60V~+60V	-300~+300V
	Resolution	10uV	0.1mV	1mV
	Accuracy	±(0.01%+0.01%FS)		
	Temperature Coefficient	±(0.001%+0.001%FS)/°C		
<b>Resistance</b>	Range	3mΩ	Resolution	0.1 uΩ
	Range	30mΩ	Resolution	1 uΩ
	Range	300mΩ	Resolution	10uΩ
	Range	3Ω	Resolution	0.1 mΩ
	Range	30Ω	Resolution	1 mΩ
	Range	300Ω	Resolution	10 mΩ
	Range	3000Ω	Resolution	0.1Ω
	Accuracy	±(0.4%+0.05%FS) ±(0.4%+0.1%FS) (3mΩ range)		
Temperature Coefficient	±(0.04%+0.005%FS)/°C ±(0.04%+0.01%FS)/°C (3mΩ range)			
<b>Specifications</b>				
<b>Sample Time</b>	<b>sample</b>	<b>R&amp;V (ms)</b>		<b>R/V (ms)</b>
	EX.FAST(50Hz)	8		4
	FAST(60Hz)	24		12
	MEDIUM(50Hz)	80		40
	MEDIUM(60Hz)	68		34
	SLOW(50Hz)	200		100
	SLOW(60Hz)	200		100
<b>* Allowable error is ±10 ms in "SLOW" status and ±2 ms in other modes.</b>				
<b>Response Time</b>	10ms (Response time is the value obtained when pure resistance is measured, and is only for reference. It may be undulation due to different DUTs)			
<b>Input Resistance</b>	≥1MΩ			
<b>Input Rating</b>	DC±300V			
<b>Channel</b>	1ch			
<b>Interface</b>	GPIB,USB,LAN			
<b>Open circuit voltage</b>	0.003Ω/0.03Ω/0.3Ω/3Ω/30Ω about 15V peak 300Ω/3000Ω about 4V peak			
<b>Fuse specification</b>	AC100V~ AC120V:1.6AT AC220V~ AC240V:1.25AT			
<b>Working temperature</b>	0°C~40°C Under 80%RH (non-condensation)			
<b>Storage temperature</b>	-10°C~50°C Under 80%RH (non-condensation)			
<b>Dimension</b>	384*230*105 (mm)			

( mm)	
Weight( net)	2.4KG

Model		IT5101E		
<b>Measurement Range</b>				
Voltage	Range	-6V~+6V	-60V~+60V	-300~+300V
	Resolution	10uV	0.1mV	1mV
	Accuracy	±(0.01%+0.01%FS)		
	Temperature Coefficient	±(0.001%+0.001%FS)/°C		
Resistance	Range	300mΩ	Resolution	10uΩ
	Range	3Ω	Resolution	0.1 mΩ
	Accuracy	±(0.4%+0.05%FS) ±(0.4%+0.1%FS) (3mΩ)		
	Temperature Coefficient	±(0.04%+0.005%FS)/°C ±(0.04%+0.01%FS)/°C (3mΩ)		
<b>Specifications</b>				
Sample Time	sample	R&V (ms)		R/V (ms)
	EX.FAST(50Hz)	8		4
	FAST(60Hz)	24		12
	MEDIUM(50Hz)	80		40
	MEDIUM(60Hz)	68		34
	SLOW(50Hz)	200		100
	SLOW(60Hz)	200		100
* Allowable error is ±10 ms in "SLOW" status and ±2 ms in other modes.				
Response Time	10ms (Response time is the value obtained when pure resistance is measured, and is only for reference. It may be undulation due to different DUTs)			
Input Resistance	≥1MΩ			
Input Rating	DC±300V			
Channel	1ch			
Interface	GPIB,USB,LAN			
Open circuit voltage	0.003Ω/0.03Ω/0.3Ω/3Ω/30Ω about 15V peak 300Ω/3000Ω about 4V peak			
Fuse specification	AC100V~ AC120V:1.6AT AC220V~ AC240V:1.25AT			
Working temperature	0°C~40°C Under 80%RH (non-condensation)			
Storage temperature	-10°C~50°C Under 80%RH (non-condensation)			
Dimension ( mm)	384*230*105 (mm)			
Weight( net)	2.4KG			

Model		IT5101H		
<b>Measurement Range</b>				
Voltage	Range	-10V~+10V	-100V~+100V	-1000~+1000V
	Resolution	10uV	0.1mV	1mV
	Accuracy	±(0.01%+0.01%FS)		

	Temperature Coefficient	$\pm(0.001\%+0.001\%FS)/^{\circ}C$		
<b>Resistance</b>	Range	3m $\Omega$	Resolution	0.1 $\mu\Omega$
	Range	30m $\Omega$	Resolution	1 $\mu\Omega$
	Range	300m $\Omega$	Resolution	10 $\mu\Omega$
	Range	3 $\Omega$	Resolution	0.1 m $\Omega$
	Range	30 $\Omega$	Resolution	1 m $\Omega$
	Range	300 $\Omega$	Resolution	10 m $\Omega$
	Range	3000 $\Omega$	Resolution	0.1 $\Omega$
	Accuracy	$\pm(0.4\%+0.05\%FS)$ $\pm(0.4\%+0.1\%FS)$ (3m $\Omega$ )		
Temperature Coefficient	$\pm(0.04\%+0.005\%FS)/^{\circ}C$ $\pm(0.04\%+0.01\%FS)/^{\circ}C$ (3m $\Omega$ )			
Specifications				
<b>Sample Time</b>	<b>sample</b>	<b>R&amp;V (ms)</b>	<b>R/V (ms)</b>	
	EX.FAST(50Hz)	8	4	
	FAST(60Hz)	24	12	
	MEDIUM(50Hz)	80	40	
	MEDIUM(60Hz)	68	34	
	SLOW(50Hz)	200	100	
	SLOW(60Hz)	200	100	
<b>* Allowable error is <math>\pm 10</math> ms in "SLOW" status and <math>\pm 2</math> ms in other modes.</b>				
<b>Response Time</b>	10ms (Response time is the value obtained when pure resistance is measured, and is only for reference. It may be undulation due to different DUTs)			
<b>Input Resistance</b>	$\geq 1M\Omega$			
<b>Input Rating</b>	DC $\pm 1000V$			
<b>Channel</b>	1ch			
<b>Interface</b>	GPIB,USB,LAN			
<b>Open circuit voltage</b>	0.003 $\Omega$ /0.03 $\Omega$ /0.3 $\Omega$ /3 $\Omega$ /30 $\Omega$ about 15V peak 300 $\Omega$ /3000 $\Omega$ about 4V peak			
<b>Fuse specification</b>	AC100V~ AC120V:1.6AT AC220V~ AC240V:1.25AT			
<b>Working temperature</b>	0 $^{\circ}C$ ~40 $^{\circ}C$ Under 80%RH (non-condensation)			
<b>Storage temperature</b>	-10 $^{\circ}C$ ~50 $^{\circ}C$ Under 80%RH (non-condensation)			
<b>Dimension (mm)</b>	384*230*105 (mm)			
<b>Weight( net)</b>	2.4KG			

The above specifications may be subject to change without prior notice.

**When the current in the working circuit which is connected to the battery changes quickly may affect the measurement accuracy!**

1. In Med, add  $\pm 0.01\%FS$ ; in Fast, add  $\pm 0.02\%FS$ ; in Ex\_fast, add  $\pm 0.03\%FS$ .
2. In Med, add  $\pm 0.1\%FS$ ; in Fast, add  $\pm 0.2\%FS$ ; in Ex\_fast, add  $\pm 0.5\%FS$  (3m $\Omega$  range).
3. The above data are applicable for  $>5\%FS$  working conditions.

## 6.2 Supplemental characteristics

Recommended calibration frequency:

once a year

## **Contact US**

Thank you for purchasing ITECH products. If you have any doubt about this product, please contact us as follow.

1. Visit ITECH website [www.itechate.com](http://www.itechate.com) .
2. Select the most convenient contact for further consultation.