

Solar Array Simulator

IT-N2100 Series User Manual



Model: IT-N2100
Version: V1.0

Notices

© Itech Electronic, Co., Ltd. 2023

No part of this manual may be reproduced in any form or by any means (including electronic storage and retrieval or translation into a foreign language) without prior permission and written consent from Itech Electronic, Co., Ltd. as governed by international copyright laws.

Manual Part Number

IT-N2100

Revision

First Edition: May 30th, 2023

Itech Electronic, Co., Ltd.

Trademarks

Pentium is U.S. registered trademarks of Intel Corporation.

Microsoft, Visual Studio, Windows and MS Windows are registered trademarks of Microsoft Corporation in the United States and/or other countries and regions.

Warranty

The materials contained in this document are provided “as is”, and is subject to change, without prior notice, in future editions. Further, to the maximum extent permitted by applicable laws, ITECH disclaims all warranties, either express or implied, with regard to this manual and any information contained herein, including but not limited to the implied warranties of merchantability and fitness for a particular purpose. ITECH shall not be held liable for errors or for incidental or indirect damages in connection with the furnishing, use or application of this document or of any information contained herein. Should ITECH and the user enter into a separate written agreement with warranty terms covering the materials in this document that conflict with these terms, the warranty terms in the separate agreement shall prevail.

Technology Licenses

The hardware and/or software described herein are furnished under a license and may be used or copied only in accordance with the terms of such license.

Restricted Rights Legend

Restricted permissions of the U.S. government. Permissions for software and technical data which are authorized to the U.S. Government only include those for custom provision to end users. ITECH follows FAR 12.211 (technical data), 12.212 (computer software). DFARS 252.227-7015 (technical data--commercial products) for national defense and DFARS 227.7202-3 (permissions for commercial computer software or computer software documents) while providing the customized business licenses of software and technical data.

Safety Notices

CAUTION

A CAUTION sign denotes a hazard. It calls attention to an operating procedure or practice that, if not correctly performed or adhered to, could result in damage to the product or loss of important data. Do not proceed beyond a CAUTION sign until the indicated conditions are fully understood and met.

WARNING

A WARNING sign denotes a hazard. It calls attention to an operating procedure or practice that, if not correctly performed or adhered to, could result in personal injury or death. Do not proceed beyond a WARNING sign until the indicated conditions are fully understood and met.



NOTE

A NOTE sign denotes important hint. It calls attention to tips or supplementary information that is essential for users to refer to.

Quality Certification and Assurance

We certify that IT-N2100 series instruments meet all the published specifications at time of shipment from the factory.

Warranty

ITECH warrants that the product will be free from defects in material and workmanship under normal use for a period of one (1) year from the date of delivery (except those described in the Limitation of Warranty below).

For warranty service or repair, the product must be returned to a service center designated by ITECH.













- The product returned to ITECH for warranty service must be shipped PREPAID. And ITECH will pay for return of the product to customer.
- If the product is returned to ITECH for warranty service from overseas, all the freights, duties and other taxes shall be on the account of customer.



Limitation of Warranty

This Warranty will be rendered invalid in case of the following:

- Damage caused by circuit installed by customer or using customer own products or accessories;
- Modified or repaired by customer without authorization;
- Damage caused by circuit installed by customer or not operating our products under designated environment;
- The product model or serial number is altered, deleted, removed or made illegible by customer;
- Damaged as a result of accidents, including but not limited to lightning, moisture, fire, improper use or negligence.

Safety Symbols

	Direct current		ON (power on)
	Alternating current		OFF (power off)
	Both direct and alternating current		Power-on state
	Protective conductor terminal		Power-off state
	Earth (ground) terminal		Reference terminal
	Caution, risk of electric shock		Positive terminal

	Warning, risk of danger (refer to this manual for specific Warning or Caution information)		Negative terminal
	Frame or chassis terminal	-	-

Safety Precautions

The following safety precautions must be observed during all phases of operation of this instrument. Failure to comply with these precautions or specific warnings elsewhere in this manual will constitute a default under safety standards of design, manufacture and intended use of the instrument. ITECH assumes no liability for the customer's failure to comply with these precautions.

WARNING

- Do not use the instrument if it is damaged. Before operation, check the casing to see whether it cracks. Do not operate the instrument in the presence of inflammable gasses, vapors or dusts.
- The electronic load is provided with a power line during delivery and should be connected to a socket with a protective earth terminal. Before operation, be sure that the instrument is well grounded.
- Make sure to use the power cord supplied by ITECH.
- Check all marks on the instrument before connecting the instrument to power supply.
- Use electric wires of appropriate load. All loading wires should be capable of bearing maximum short-circuit current of electronic load without overheating. If there are multiple electronic loads, each pair of the power cord must be capable of bearing the full-loaded rated short-circuit output current
- Ensure the voltage fluctuation of mains supply is less than 10% of the working voltage range in order to reduce risks of fire and electric shock.
- If you use the power supply to charge the battery, pay attention to the positive and negative polarity of the battery when wiring, otherwise the power supply will be damaged!
- Do not install alternative parts on the instrument or perform any unauthorized modification.
- Do not use the instrument if the detachable cover is removed or loosen.
- To prevent the possibility of accidental injuries, be sure to use the power adapter supplied by the manufacturer only.
- We do not accept responsibility for any direct or indirect financial damage or loss of profit that might occur when using the instrument.
- This instrument is used for industrial purposes, do not apply this product to IT power supply system.
- Never use the instrument with a life-support system or any other equipment subject to safety requirements.

CAUTION

- Failure to use the instrument as directed by the manufacturer may render its protective features void.
- Always clean the casing with a dry cloth. Do not clean the internals.
- Make sure the vent hole is always unblocked.

Environmental Conditions





The instrument is designed for indoor use and an area with low condensation. The table below shows the general environmental requirements for the instrument.

Environmental Conditions	Requirements
Operating temperature	0°C to 40°C
Operating humidity	20%-80% (non-condensation)
Storage temperature	-10°C to 70 °C
Altitude	Operating up to 2,000 meters
Pollution degree	Pollution degree 2
Installation category	II

Note

To make accurate measurements, allow the instrument to warm up for 30 min before operation.

Regulatory Markings

	The CE mark indicates that the product complies with all the relevant European legal directives. The specific year (if any) affixed refers to the year when the design was approved.
	The UKCA mark indicates that the product complies with all relevant UK legal regulations (if accompanied by a year, it indicates the year the design was approved).
	The instrument complies with the WEEE Directive (2002/96/EC) marking requirement. This affixed product label indicates that you must not discard the electrical/electronic product in domestic household waste.
	This symbol indicates the time period during which no hazardous or toxic substances are expected to leak or deteriorate during normal use. The expected service life of the product is 10 years. The product can be used safely during the 10-year Environment Friendly Use Period (EFUP). Upon expiration of the EFUP, the product must be immediately recycled.

Waste Electrical and Electronic Equipment (WEEE) Directive



This product complies with the WEEE Directive (2002/96/EC) marking requirement. This affix product label indicates that you must not discard the electrical/electronic product in domestic household waste.

Product Category

With reference to the equipment classifications described in the Annex I of the WEEE Directive, this instrument is classified as a "Monitoring and Control Instrument".

To return this unwanted instrument, contact your nearest ITECH office.

Compliance Information

Complies with the essential requirements of the following applicable European Directives, and carries the CE marking accordingly:

- Electromagnetic Compatibility (EMC) Directive 2014/30/EU
- Low-Voltage Directive (Safety) 2014/35/EU

Conforms with the following product standards:

EMC Standard

IEC 61326-1:2012/ EN 61326-1:2013 ¹²³

Reference Standards

CISPR 11:2015+A1:2016 Ed 6.1

IEC 61000-3-2: 2018 RLV

IEC 61000-3-3: 2013+A1:2017

IEC 61000-4-2:2008

IEC 61000-4-3 2006+A1:2007+A2:2010/ EN 61000-4-3 A1:2008+A2:2010

IEC 61000-4-4:2012

IEC 61000-4-5:2014+A1:2017

IEC 61000-4-6:2013+cor1:2015

IEC 61000-4-11:2004+A1:2017

1. The product is intended for use in non-residential/non-domestic environments. Use of the product in residential/domestic environments may cause electromagnetic interference.
2. Connection of the instrument to a test object may produce radiations beyond the specified limit.
3. Use high-performance shielded interface cable to ensure conformity with the EMC standards listed above.

Safety Standard

IEC 61010-1:2010+A1:2016

Content

Quality Certification and Assurance	I
Warranty	I
Limitation of Warranty.....	I
Safety Symbols.....	I
Safety Precautions	II
Environmental Conditions.....	III
Regulatory Markings.....	III
Waste Electrical and Electronic Equipment (WEEE) Directive.....	IV
Compliance Information.....	V
Chapter 1 Inspection and Installation	1
1.1 Verifying the Shipment	1
1.2 Instrument Size Introduction.....	1
1.3 Adjustment of Power Handle.....	3
1.4 Mounting Brackets.....	4
1.5 Connecting the Power Cord	4
1.6 Connecting the DUT	5
1.7 Options Introduction	7
Chapter 2 Quick Reference	8
2.1 Brief Introduction	8
2.2 Front-Panel Overview.....	9
2.3 Keyboard Introduction	10
2.4 Status Bar Indicator Description	10
2.5 Rear Panel Introduction.....	11
2.6 Introduction of Side Air Holes	12
2.7 Power-on Selftest	12
Chapter 3 Function and Features	15
3.1 Switching of Local/Remote Operation Modes	15
3.2 Output On/Off Operation	15
3.3 Power State CC/CV Switching.....	15
3.4 Meter Interface	16
3.5 View Interface.....	21
3.6 System Interface.....	22
3.7 Config Interface	24
3.8 Program Interface.....	25
3.9 Factory Interface.....	36
3.10 Protect Interface	36
3.11 Trigger Function	38
3.12 Inner Load Switch Settings.....	39
3.13 Keyboard Lock Function.....	40
3.14 Rear Panel Terminal Functions	40
Chapter 4 Remote Control.....	41
4.1 USB Interface	41
4.2 LAN Interface.....	41
Chapter 5 Technical Specification.....	44
5.1 Main Technical Parameters	44
5.2 Supplemental Characteristics.....	55
Appendix	56
Specifications of Red and Black Test Cables.....	56

Chapter 1 Inspection and Installation

The power supply is a device with a high safety rating and has a protective earth terminal. Before installation or operation, please check and read the safety signs and instructions in this manual.

1.1 Verifying the Shipment

Unpack the box and check the contents before operating the instrument. If wrong items have been delivered, if items are missing, or if there is a defect with the appearance of the items, please contact the ITECH authorized dealer or after-sales service department immediately.

The package contents include:

Item	Qty.	Model	Remarks
Programmable DC Power Supply	x1	IT-N2100 Series	IT-N2100 Series include: IT-N2121, IT-N2131, IT-N2123 and IT-N2133
Power cord	x1	IT-E171/ IT-E172/ IT-E173/ IT-E174	Users can choose different power cords according to the specifications of power sockets in the region. For detailed specifications, please refer to 1.5 Installing Power Cords.
USB communication cable	x1	-	This accessory is selected when the USB interface is used for starting up remote operation.
Ex-factory Test Report	x1	-	It contains the test report of the instrument before delivery.

Note

After confirming that the package contents are consistent and there is no problem, please keep the packing box and related contents properly. When the instrument is returned to the factory for service, it needs to meet the packing requirements.

1.2 Instrument Size Introduction

The instrument should be installed at well-ventilated and rational-sized space. Please select appropriate space for installation based on the instrument size.

IT-N2121, IT-N2131, IT-N2123 and IT-N2133 models

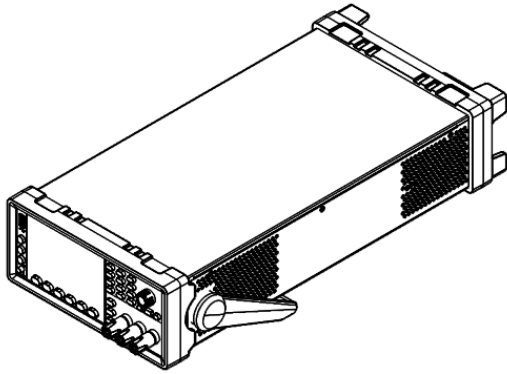

Detailed Dimension Drawing

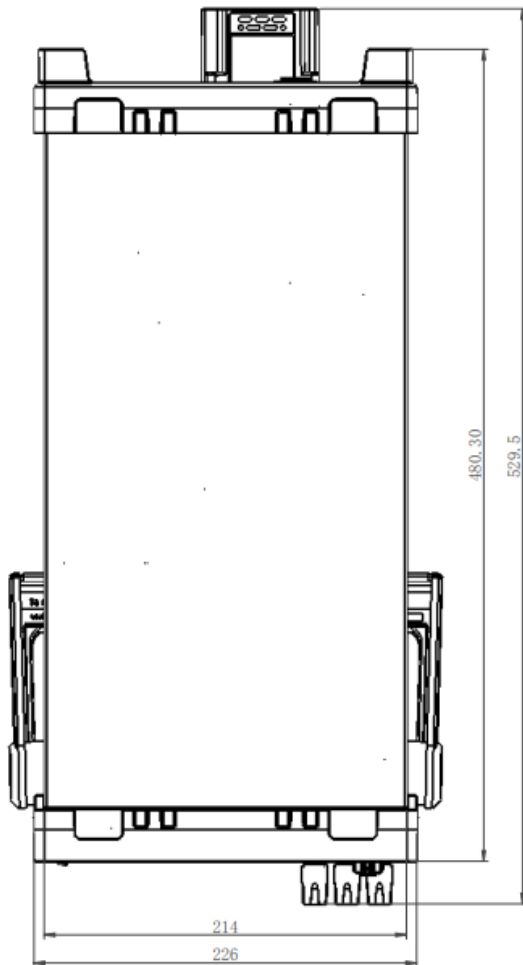
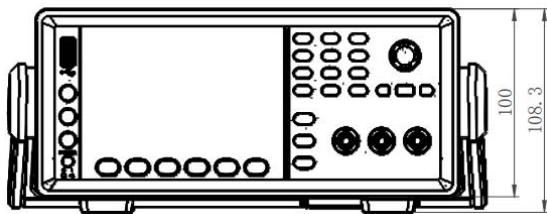

1.3 Adjustment of Power Handle

The power handle can be adjusted to three common state positions as shown in the figure below. Note that when adjusting the handle, it should be adjusted to the corresponding position with moderate force.

Note: The following picture is used to demonstrate the position of the handle, the actual appearance should be subject to the actual product.

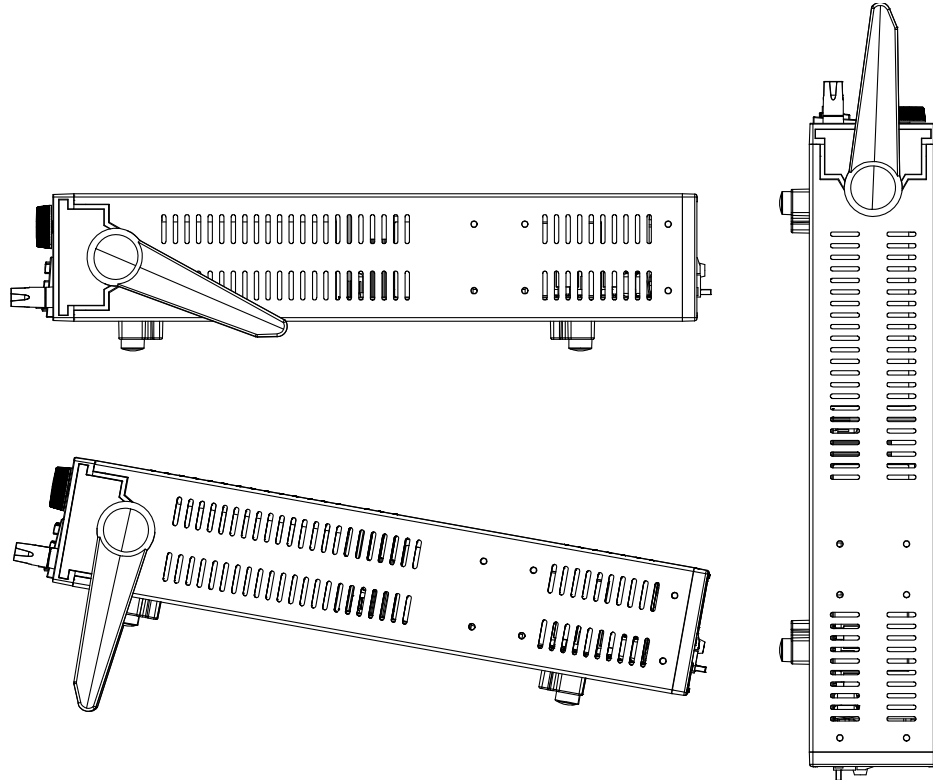

If the handle is not required, the handle can be removed, the method of removal is:

Adjust the handle to the position as shown in the figure below, and then pull it to the sides with both hands.

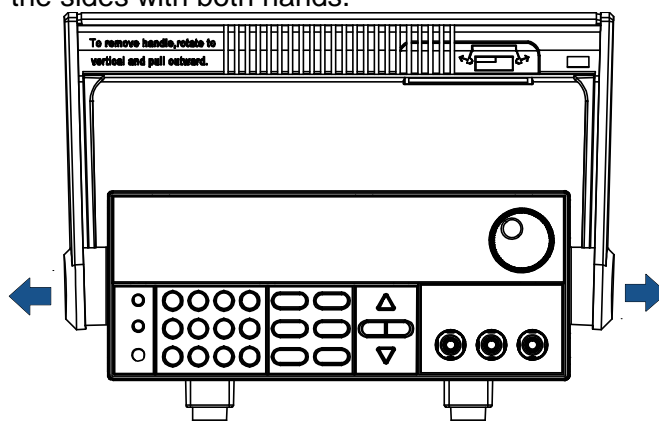

 Note

When installing and removing the power handle, don't use too much force to avoid pinching your hand.

1.4 Mounting Brackets

IT-N2100 series power supplies can be installed on standard 19-inch brackets. ITECH has prepared the IT-E158 bracket as a mounting kit for users. Users can select the corresponding bracket manual for installation according to the specific bracket model purchased.

Before installing the IT-N2100 series power supply on the rack, please remove the rubber shock absorber and handle at the front of the instrument, and the rubber shock absorber at the rear of the instrument.

WARNING

Do not block the front half of the intake vents on the side of the instrument, the rear half of the side vents, and the exhaust vents on the rear panel.

Remove the Shock Absorber

Tighten one corner of the rubber shock and slide it out.

Remove the Handle

1. Grasp the edge of the handle and pull it outward. This will rotate it.
2. Turn the handle to the vertical position and lower the instrument horizontally.
3. Pull the handle outwards, then lift up.

CAUTION

To replace the handle, pay attention to its orientation. It will be damaged if placed in the wrong direction

1.5 Connecting the Power Cord

Connect power cord of standard accessories and ensure that the power supply is under normal power supply.

AC Power Input Level

The AC input on the rear of the instrument is a general AC input. It accepts nominal line voltages in the range of 100 VAC to 240 VAC. 50 Hz or 60 Hz required.

Note: When the AC input of 1500W model is 110VAC, the output power is derated to 850W.

Categories of Power Cables

Select from the following schedule of power cord specifications an appropriate power cord that matches the voltage for the area in which you use the

instrument. If the power cord included in the instrument you purchased doesn't match the voltage, contact the dealer or manufacturer for change..

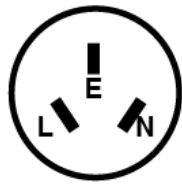

China
IT-E171



United States &
Canada & Japan
IT-E172

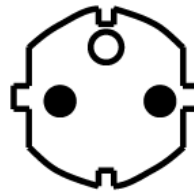

Europe
IT-E173



England
IT-E174

1.6 Connecting the DUT

WARNING

- Before connecting DUT, be sure to switch off the instrument.
- If the DUT is a battery, do not short-circuit the battery. Shorted battery can cause serious injury.
- It is recommended to connect a fuse in series between the power supply and the battery when testing the battery to prevent short circuit caused by any case.
- Before connecting the test lines, please confirm the maximum current that the test lines can withstand.
- During wiring, check that the anode and cathode of the test lines are properly and tightly connected; anode ON and cathode OFF are prohibited.
- If the object to be tested is a battery, when wiring, please take measures to prevent reverse connection of the battery and prevent sparks.
- Ensure that the output terminals are either insulated or covered using the safety covers provided, so that no accidental contact with lethal voltages can occur.
- Dangerous voltages may be present on the output terminals from external energy sources such as batteries. The external energy source must be disconnected before touching the output or sense terminals.

The front and rear panels of this series power supply can be connected to the DUT. **The maximum output current of the front panel terminals is 10A. If the current to be tested exceeds 10A, please be sure to connect the rear panel output terminals.**

Local Measurement

The instrument is local output by default, that is, the **Menu > System > Source > Remote Sense** function is **Off**.

To use local measurement, connect the DUT as shown in the figure below.

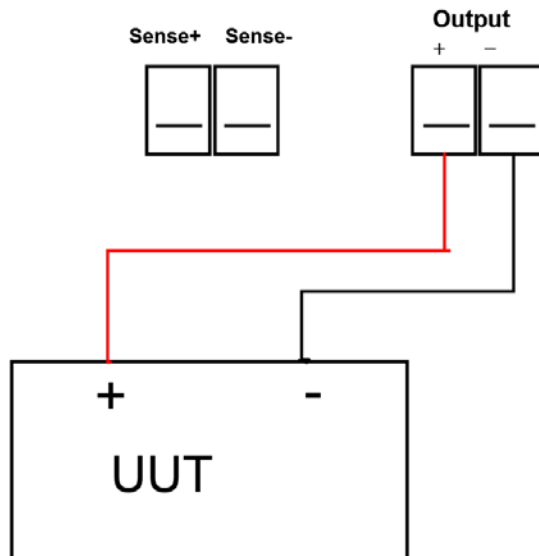

Remote Measurement Function (Sense)

Menu > System > Source > Remote Sense is set to **On** to indicate that the remote measurement function is enabled, and connect the DUT as shown in the figure below.

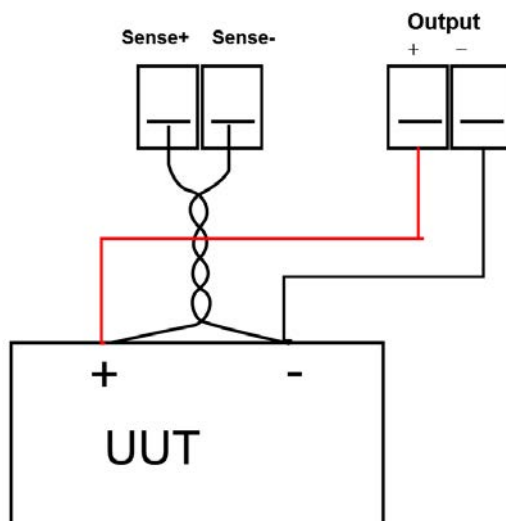

NOTE

To ensure the stability of the system, use shielded twisted-pair cables between the remote sense terminals and the DUT. Pay attention to the positive and negative poles when wiring, otherwise it will damage the instrument. When the remote measurement function is turned on, don't leave the sense terminal unconnected.

1.7 Options Introduction



The following optional accessories provided by the company are sold separately, and users need to purchase them separately according to their needs.

IT-N2100 series power supplies can be installed on standard 19-inch brackets. ITECH has prepared the IT-E158 bracket as a mounting kit for users.

Please refer to the "IT-E158 User Manual" for a detailed installation guide for the cabinet.

Chapter 2 Quick Reference

This chapter briefly introduces the front panel, rear panel, keyboard key functions and screen display functions of the IT-N2100 series power supply, so as to ensure that you can quickly understand the appearance, structure and key functions of the power supply before operating the power supply, so as to help you make better use of this series of power supplies.

2.1 Brief Introduction

IT-N2100 series solar array simulator is a high performance DC power supply with fast change of IV curve. It can simulate the IV output characteristics of various solar panels under different environments (temperature, light, shadow decay, aging). It can be applied for the tests of solar micro-inverter, power optimizer, satellite power system, sail power array and so on. IT-N2100 has low ripple, low noise and fast MPPT, supports multi-channel synchronous control and high voltage topology.

The main features and benefits are as follows:

- Precise simulation of the IV characteristics output of silicon, GaAs and other types of solar PV panels
- Built-in solar array simulation software, supporting multi-channel control
- High-speed current dynamic response to support fast MPPT for microinverters
- Up to 1500V DC output common-mode withstand voltage, supporting series testing of the DUT
- Fixed mode, adjustable output impedance, can simulate CC, CV, CP output
- Ultra-low current ripple, high precision sampling, programming and measurement
- Simulate I-V curve under different temperature and light
- Built-in EN50530, Sandia, NB/T32004, CGC/GF004, CGC/GF035 regulations dynamic model test, and generate reports
- Graphical operation interface, real-time display of MPPT status of PV inverter
- Dynamic list sequence programming: 100 steps x 20 data sets
- Real-time data and curve recording for further analysis
- Simulation of dynamic and static I-V curves of solar panels under cloud shadow
- Table mode supports I-V curve fitting with 4096 points
- Quickly generate I-V by setting V_{oc} , I_{sc} , V_{mp} , I_{mp} by four-point method
- Comprehensive curve protection: OVP, OCP, OPP, OTP
- Small size: 2U half rack for single channel
- 4.3" HD LCD, easy to operate

- Front and rear panel output, adaptable to bench top and system integration for various applications
- Standard communication interface LAN, USB, digital I/O, support SCPI

Model	Voltage	Current	Power
IT-N2121	80V	25A	800W
IT-N2131	80V	25A	1500W* ¹
IT-N2123	150V	10A	800W
IT-N2133	150V	10A	1500W* ¹

*1 At 110Vac input, the power is 850W

2.2 Front-Panel Overview

The front panel of IT-N2100 is introduced as follows.

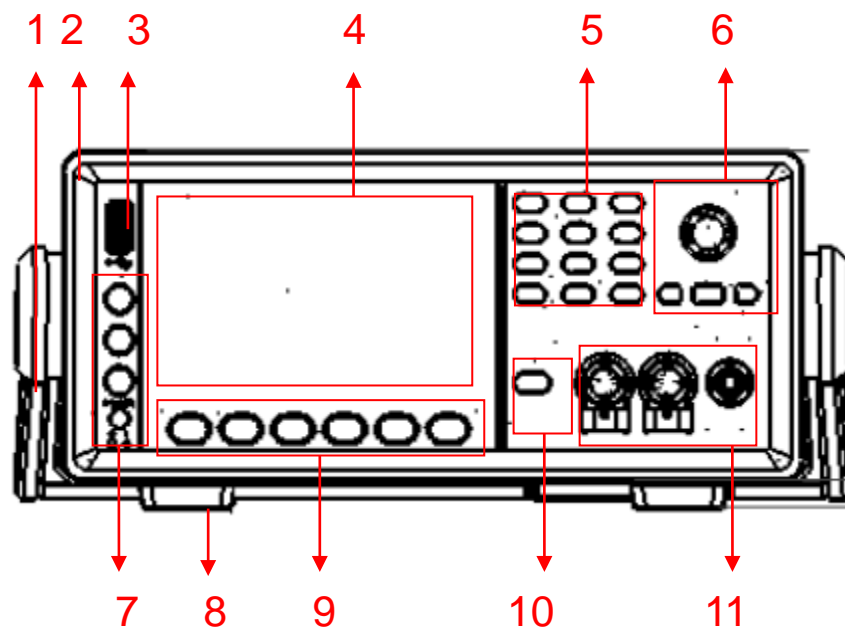



1. Handle (removable)
2. Rubber shock absorber (front)
3. The USB port allows for various functions such as screen capture, data recording, and importing/exporting of photovoltaic curves or List files.
4. 4.3" HD LCD
5. Numeric keys (compound function) and ESC escape key

6. Pressable pulsating knob, left and right direction keys, Enter key
7. Shift compound key, View switch key, Menu key and power switch
8. Foot (removable)
9. The function keys corresponding to the menu at the bottom of the screen (different menus are displayed on different screens)
10. On/Off output switch key
11. Output terminals (front panel terminals are used to facilitate wiring, but the maximum current can only be 10A)



















2.3 Keyboard Introduction

The key descriptions are as follows:

Key name	Function Description
Shift	Compound keys, used in combination with other keys to achieve compound menu settings
View	View switch button. In any interface, press the [View] key to switch between the Meter interface and the Recorder interface.
Menu	Menu function keys
Power	Power switch button
0-9	Numeric input keys
	Decimal point
Esc	Cancel/Return key
Shift+1	Config menu shortcut keys
Shift+2	Protect function shortcut keys
Shift+3	System menu shortcut keys
Shift+4	Program (List and SAS) menu shortcut keys
Shift+5	The Trig function shortcut key allows for quick triggering of List or SAS functions.
Shift+6	The Lock function shortcut key is used to lock the panel keys.
Shift+7	The local key returns the power supply from remote mode to local mode.
Shift+ 	Screen print key, insert the U disk in FAT 32 format before use.
On/Off	The output on/off key is used to control the output state of the power supply.

2.4 Status Bar Indicator Description

Status bar indicator and descriptions are as follows:

Indicator	Description	Indicator	Description
	U disk inserted		LIST is running
	Sense remote measurement function is enabled		LIST runs waiting for trigger status
	The power supply works in CC mode		OVP overvoltage protection
	The device is under remote control		OCP overcurrent protection
	UCP undercurrent protection		Foldback protection
	OTP over temperature protection		Keyboard lock function is on
	OPP overpower protection		Sense protection
	Executing error		Output off state
	Power supply works in CV mode		Output disabled in Inhibit state.

2.5 Rear Panel Introduction

The rear panel of IT-N2100 is introduced as follows.

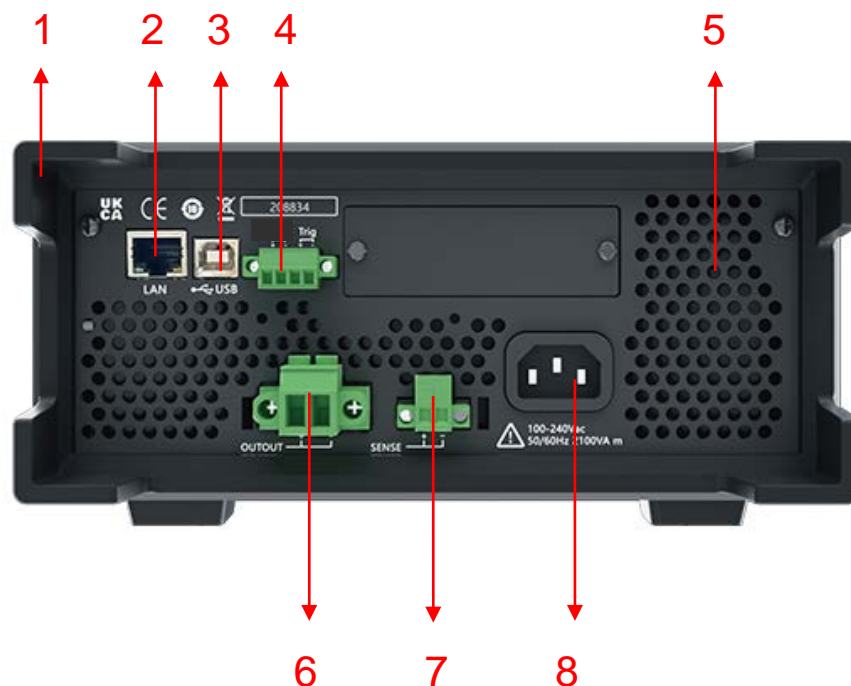

1. Rubber shock absorber (rear)
2. LAN communication interface
3. USB communication interface
4. Inhibit (inhibit output) and trigger function terminals
5. Heat dissipation window (air outlet)
6. DC output terminal (rated current output terminal, current can be greater than 10A)
7. Remote measurement terminal (Sense)
8. AC power input socket

2.6 Introduction of Side Air Holes



1. Air inlet
2. Air outlet

2.7 Power-on Selftest

A successful selftest indicates that the purchased power product meets delivery standards and is available for normal usage.

Before operation, please confirm that you have fully understood the safety instructions.

WARNING

- To avoid burning out, be sure to confirm that power voltage matches with supply voltage.
- Be sure to connect the main power socket to the power outlet of protective grounding. Do not use terminal board without protective grounding. Before operation, be sure that the power supply is well grounded.
- To avoid burning out, pay attention to marks of positive and negative polarities before wiring.

Selftest Steps

The normal self-test process of the power supply is as follows:

1. Connect the power cord correctly, press the power button to turn on the

power.

Power supply self-test.

- After the power supply self-test is completed, the screen displays as below.

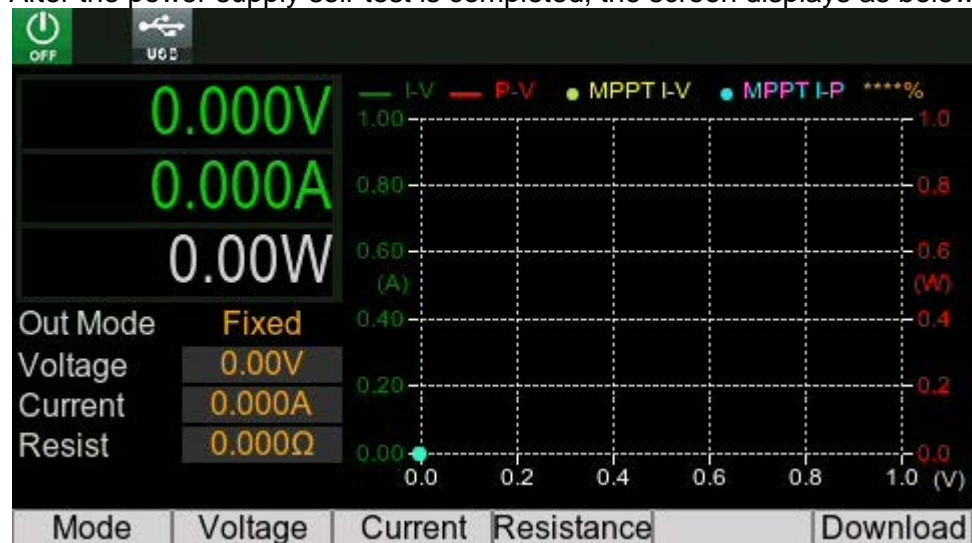

Error Information References

The following error information may occur when an error occurs during Power On self-test:

- If the EEPROM was damaged, the VFD will display “EEPROM FAIL”.
- If the last power status in EEPROM is lost, then VFD will display “SYST LOST”.
- If the calibration data in EEPROM is lost, then VFD will display “CAL LOST”.
- If the factory calibration data in EEPROM is lost, and then the VFD will display “FACT LOST”.

When encountering the above error message, it is recommended to perform a factory reset first (**Menu > System > Source > Reset**). If the error message persists even after the factory reset, please return the device for repair.

Exception Handling

If the power supply cannot start normally, please check and take measures by reference to steps below.

- Check whether the power cord is correctly connected and confirm whether the power supply is powered.
 Correct wiring of power cord => 2
 Incorrect wiring of power cord => Re-connect the power cord and check whether the exception is removed.

2. Check whether the power in On. Power key is under “” On status.
Yes => 3
No => Please check the Power key to start power and check whether the exception is removed.
3. If the power supply still cannot be turned on normally, please contact ITECH after-sales technical support.

Chapter 3 Function and Features



This chapter will describe the functions and characteristics of the power supply in detail.

3.1 Switching of Local/Remote Operation Modes

The power supply provides two modes of operation, local operation and remote operation. Switching between the two operating modes is possible through communication commands. Power initialization mode defaults to local operation mode.

- Local operation mode: use the buttons on the power supply body to perform related operations.
- Remote operation mode: The power supply is connected to the PC, and the related operations of the power supply are performed on the PC. When the power supply is in remote operation mode, except for the **[Shift] + [7] (Local)** keys, other keys on the panel have no effect. It is possible to switch to local operating mode with the **[Shift] + [7] (Local)** keys. When the operating mode is changed, the output parameters of the power supply will not be affected.

3.2 Output On/Off Operation

You can control the output switch of the power supply by pressing the  key on the front panel. The  key light is on, indicating that the output is turned on, and the  key light is off, indicating that the output is turned off. When the power is on, the working status sign (CV/CC) on the screen will be lit.

Note

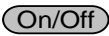
After the power supply is connected to the DUT, press the  key to turn on the output. If the power supply has no output after the output is turned on, please check the voltage and current setting values, please set both the voltage and current to non-zero values, and then turn on the output.

3.3 Power State CC/CV Switching

The output voltage of the power supply and the resistance of the load determine the output current. Only when the output current is lower than the set current limit, the power supply outputs in constant voltage CV mode, and it is indicated by CV status.

If the output current is limited by the current set value or rated current, the power supply will switch to constant current CC mode output, and it will be indicated by the CC status.

the power supply switches between CC and CV states according to the actual current in the loop.

3.4 Meter Interface

After the power is turned on, the following interface is displayed:

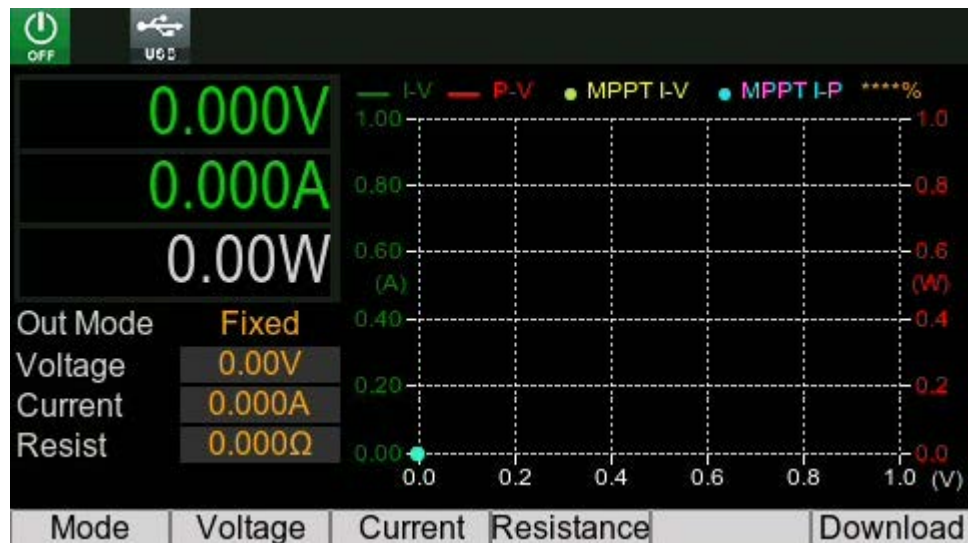

Press the  buttons corresponding to each function at the bottom of the screen to quickly set the power output mode and the corresponding parameters in each mode.

The setting here is the shortcut setting item of the Program menu under the Menu. If you need more parameter setting items, please enter the Program menu under the Menu to set.

Once the parameter settings in each mode are modified, the Download button light will flash, prompting the user to press the Download button to make the parameter modification take effect.

Mode Introduction

The power supply supports the following working modes (press the **[Mode]** key):

- Fixed: fixed mode
- Curve: curve mode
- Table: table mode
- User: user-defined mode

Fixed

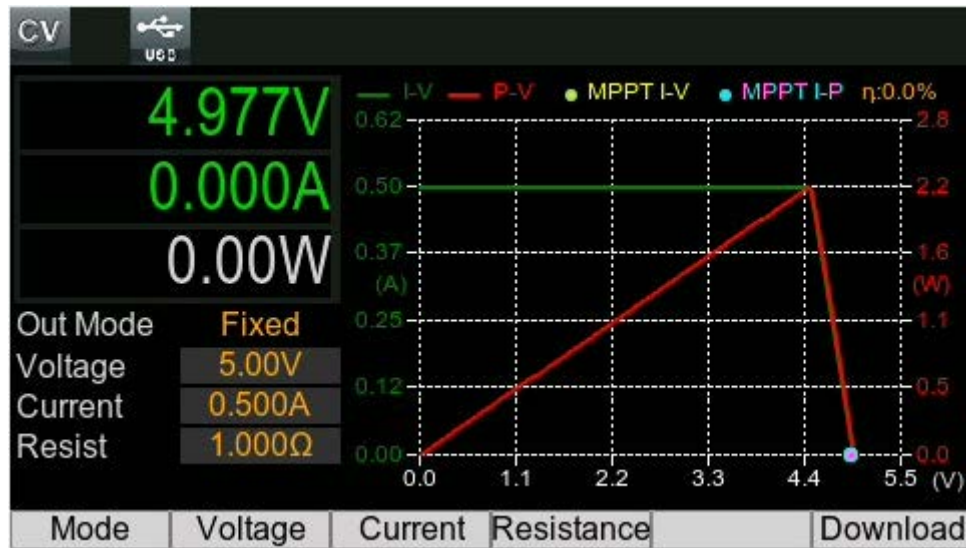

This is the default mode that occurs when the unit is first powered up or when using *RST. The I-V output has the rectangular characteristics of a standard power supply.

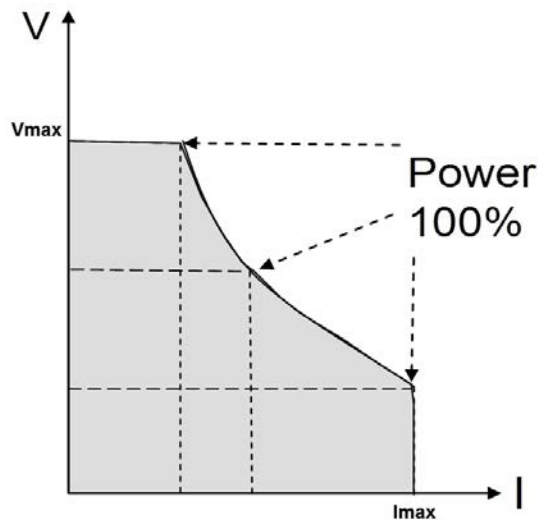

In Fixed mode, users can set the following parameters:

1. Voltage Setup

The voltage setting range is from 0V to the maximum output voltage value. When the **[Voltage]** key is pressed, the key light will be lit, and the voltage setting operation can be performed at this time. The following methods can be used to set the output voltage value through the front panel.

- After the power is turned on, press the **[Voltage]** key, use the left/right direction keys to adjust the cursor to the specified position, and rotate the knob to adjust the voltage setting value.

- After the power is turned on, press the **[Voltage]** key and the **[0]** to **[9]** number keys and then press the **[Enter]** key to set the voltage value.

2. Current Setup

The range of current setting is between 0A and full rated output current. When the **[Current]** key is pressed, the key light will be lit, and the current setting operation can be performed at this time. The following methods can be used to set the output current value through the front panel.

- After the power is turned on, press the **[Current]** key, use the left/right direction keys to adjust the cursor to the specified position, and rotate the knob to adjust the current setting value.
- After the power is turned on, press the **[Current]** key and the **[0]** to **[9]** number keys and then press the **[Enter]** key to set the current value.

3. Resistance Setup

Setting the output resistance value can simulate the voltage drop of the output voltage due to the resistance.

After the above parameter settings are modified, you must press the Download key to take effect.

Curve

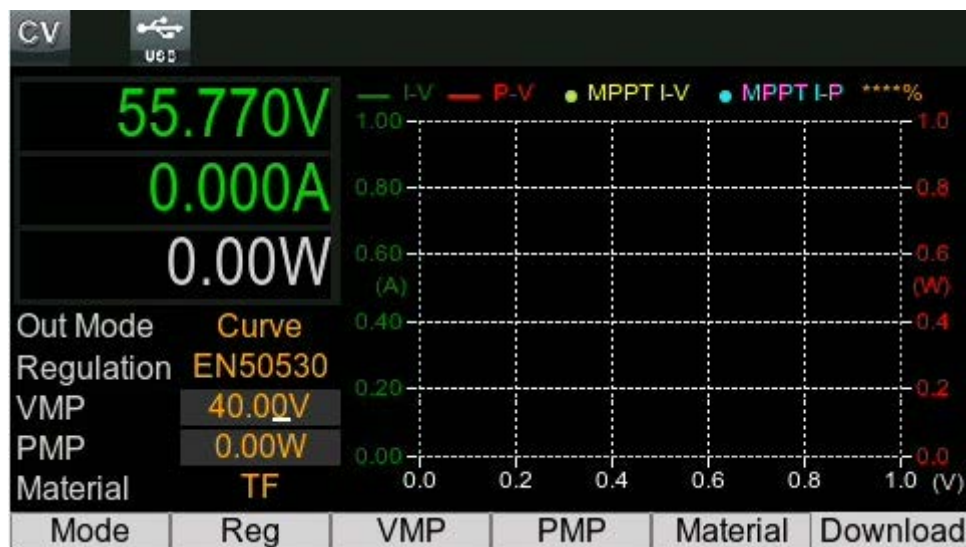

PV analog output in regulation mode. Support setting regulations, materials, Vmp and Pmp.

Table



PV analog output in Table mode. Support setting Voc and Isc parameters. Users can edit parameters through the panel keys, or import csv files through U disk for quick editing.

In Table mode, the output characteristic is determined by a user-defined table of I-V points as illustrated in the following figure. Table mode operation is achieved by sampling the output voltage, applying a low-pass filter, and continually adjusting the constant current loop by using the filtered voltage as an index into the stored table of points.

Linear interpolation is used to set the current when the filtered voltage does not have an exactly matching table entry. What this means is that the I-V curve is generated by connecting the points in the table by straight lines. The more points that you provide, the more accurate the curve will be when the points are connected.

Each point is defined by an I-V coordinate-pair that define the location of the point on the curve. The first value is the voltage; the second value is the current. If no $V=0$ value is provided, the current associated with the lowest voltage value is defined as Isc and the curve will be extended horizontally to the current axis. If no $I=0$ value is provided, the slope that was determined by the last two current values will be extended to the voltage axis.

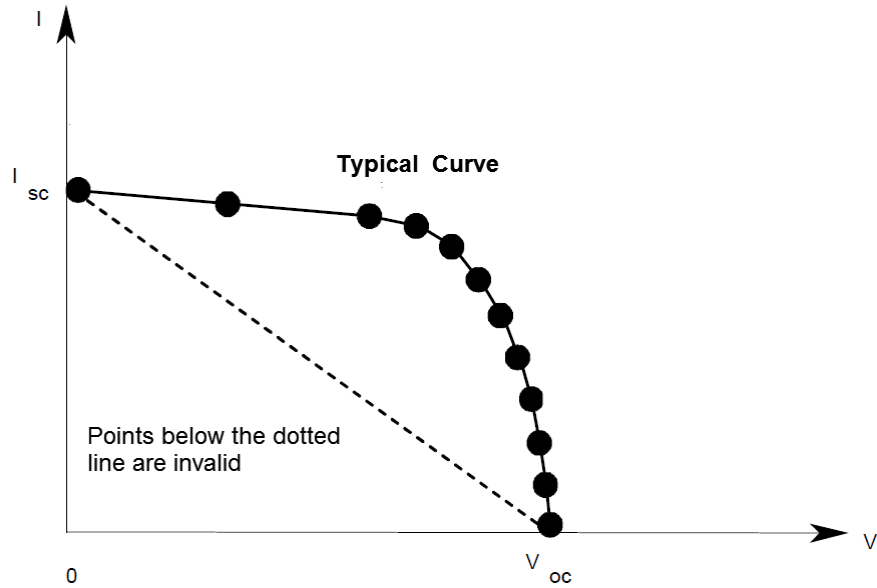

User



The User-define mode is the four-point mode, which uses the exponential model to approximate the I-V curve, as shown in the figure below.

It is programmed in terms of its open circuit voltage (V_{oc}), short circuit current (I_{sc}), maximum voltage point (V_{mp}), and maximum current point (I_{mp}) at the approximate peak power point. SAS operation is achieved by sampling the output voltage, applying a low-pass filter, and continually adjusting the constant current loop by using the filtered voltage as an index into the exponential model.

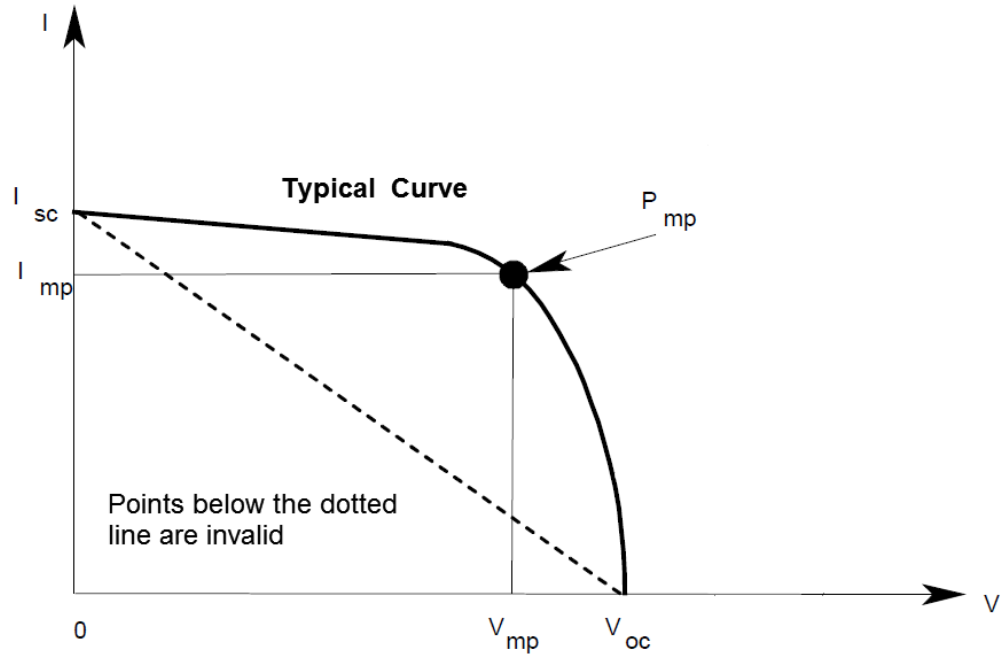

3.5 View Interface

The View function enables trend analysis by displaying voltage, current, and power curves for monitoring the long-term operation of the DUT. Additionally, it allows real-time data saving to a USB drive during the testing process. The saved data files can be in the formats **.csv** and **.Tdms**, providing flexibility for further analysis and post-processing.

After pressing the View button, the interface is displayed as follows:

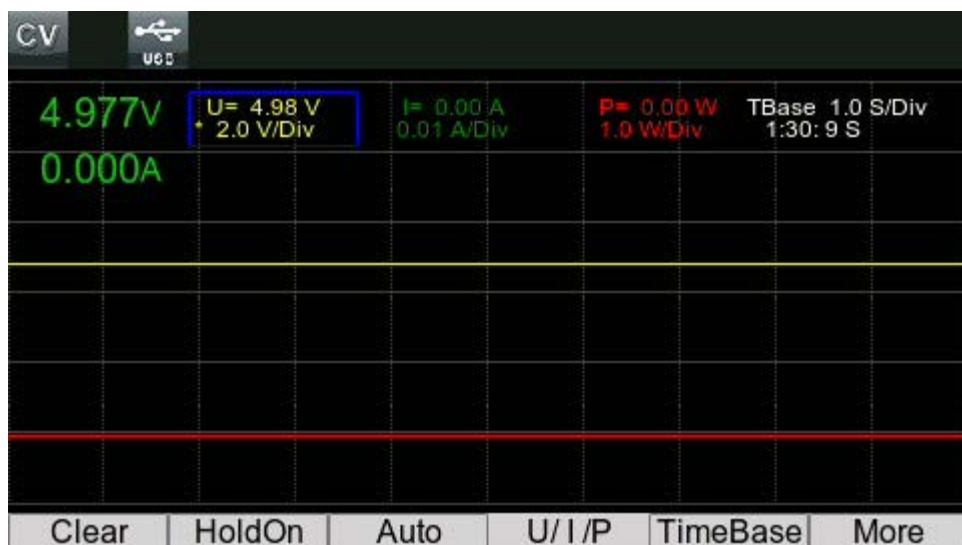

- Clear: Clear the currently recorded data
- HoldOn / HoldOff: Pause or continue curve drawing

- Auto: Waveform scale self-adaptation, according to the actual output voltage/current/power value, automatically adjust the waveform display to a suitable scale.
- U / I / P: The resolution of voltage, current, and power waveform display, that is, the voltage, current, and power values represented by each grid on the Y-axis. The setting method is: first press the button at the bottom of the screen to switch the U / I / P option, then turn the knob or press the left / right direction key to adjust the value.
- TimeBase: Time base resolution adjustment, that is, the time represented by each grid on the X-axis.
- More: View function configuration menu, the specific parameters are introduced as follows.
 - Line Config: Set whether the voltage waveform (L1/Volt), current waveform (L2/Curr), and power waveform (L3/Pow) are displayed in the **Recorder** interface, set to **On** means to display the corresponding waveform, set to **Off** means not to display .
 - Advance Config: Save the real-time collected data to the U disk, and the file format can be **.csv** or **.Tdms**.

3.6 System Interface

[Shift] + [3] (System) menu contains the settings for the following functional parameters of the power supply, which are described as follows:

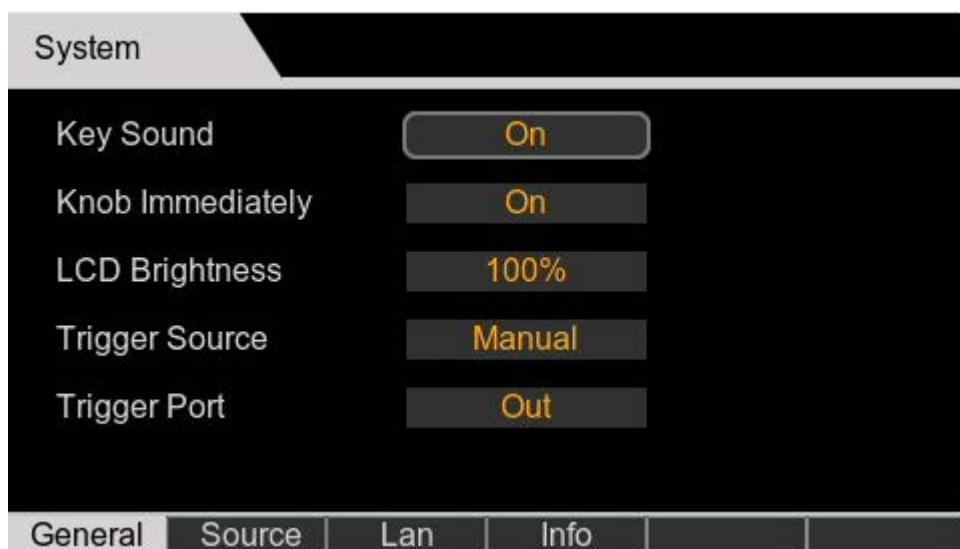

The parameter setting method is as follows:

1. Press the corresponding button at the bottom of the screen to switch to the corresponding page, such as General.
2. In the General interface, turn the knob or press the left/right direction keys to adjust the cursor on the specified parameter.

3. Press **[Enter]** to enter the parameter modification state.
4. Adjust the parameter value by turning the knob or pressing the left/right direction keys.
5. Press **[Enter]** to confirm the modification.

General	Key Sound	OFF	Set no sound when pressing the keyboard
		ON	Make a sound when you press the keyboard
	Knob Immediately	OFF	Setting the pulsation knob adjustment does not take effect immediately, and needs to manually press the [Enter] key to take effect.
		ON	Set the pulsation knob adjustment to take effect immediately.
	LCD Brightness		To adjust screen brightness:10%~100%
	Trigger Source	Manual	The trigger method is [Shift] + [5] key trigger
		Bus	The trigger mode is *TRG command trigger
		External	Trigger mode is external signal trigger
	Trigger Port	In	The signal direction of the Trig pin is the input signal, that is, when the Trig pin receives a low-level trigger signal, the instrument performs a trigger operation.
		Out	The signal direction of the Trig pin is the output signal, that is, when the instrument receives a panel key or command trigger, it outputs a low-level signal through the Trig pin.
Source	Power-On Setup	Reset	Set the parameters to the system defaults when the power is turned on.
		Last	Set the parameters when the power is turned on to the parameters at the last shutdown, and the output state is the same as the state before shutdown.
		Last+Off	Set the parameters when the power is turned on to the parameters when the power was turned off last time, and the output state is OFF .
	Remote Sense	Off	Sense switch off
		On	Sense switch on

	Leak Circuit	On	Turn on the internal load. When the output voltage is within 30V, the absorption current is about 200mA, and if the output voltage is above 30V, the power absorption is about 10W.
		Off	Turn off the internal load.
	Reset	No	Keep the original menu settings unchanged
		Yes	Restore factory defaults
Lan	Mode		<ul style="list-style-type: none"> ● Auto: Automatically set IP address and other information ● Manual: Manually set the IP address and other information. After selecting Manual, the following editable setting items will appear. <ul style="list-style-type: none"> - IP: IP address settings - Mask: Subnet mask setting - Gateway: Gateway address setting
Info	Product Model		Instrument model
	SN		Instrument serial number
	Soft Version		Instrument software version
	MAC		Instrument MAC address
	Hardware Version		Instrument hardware version

3.7 Config Interface

[Shift] + [1] (Config) interface contains the parameter settings of the following power functions, which are described as follows:

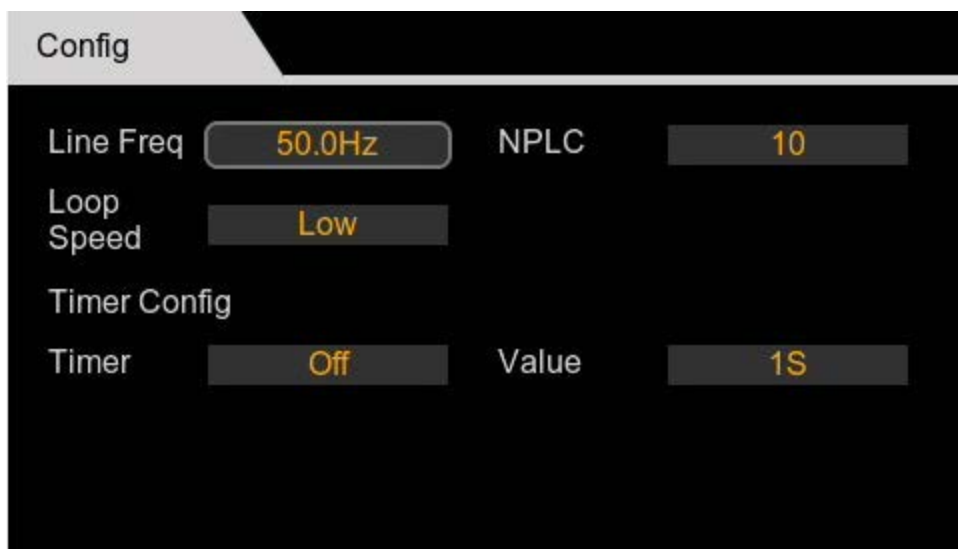

Line Freq	The frequency of the AC line can be set to 45Hz~70Hz.
NPLC	Set the measurement speed, setting range: 1~25. The larger the value of NPLC is, the slower the measurement speed is, and the display of the Meter value is relatively more stable.
Loop Speed	Set the loop speed: high, medium and low three speeds.
Timer	Output timer settings: Off: Turn off the output timer On: Turn on the output timer, and you need to set the seconds of the timer, the setting range is 1~9999, and the step is 1s.

3.8 Program Interface

The Program interface provides waveform editing, running, import/export and other functions in 4 modes.



Introduction

- Mode: Mode selection, supports Fixed, User, Curve, Table four modes.
- Open: Select Program file
 - Internal: Select the Program file saved in the internal memory of the instrument. The save address is 1~20, that is, up to 20 files can be saved.
 - USB: Select the Program file saved in the root directory of the external U disk (the U disk has been plugged in at the front panel).

Note: The Program file stored in the root directory of the U disk must be in .csv format, and the file must meet the requirements of the template. Users can save a Program file template to the root directory of the U disk through Edit > Save As > USB, so that they can edit the .csv file on the computer later, and re-import the edited .csv file into the instrument for operation.

- Edit: Edit the Program file. The waveform parameters to be edited are different in different modes.

The buttons common to all four modes are introduced as follows:

- Save: Save the currently edited Program file.
- Save As: Save the currently edited Program file as the specified address.
- Clear: Clear the currently edited waveform data.
- Delete: Delete the currently selected row of data.
- Insert: Insert a Step before the selected Step.
- Return: Return to the main interface of Program.

- Run / Stop: Run or stop Program
- Pause: Pause Program operation.
- Next: Program runs in single-step mode, press the **[Next]** button to trigger the execution of the next Step.

Fixed Program

Press the **[Edit]** button to enter the following interface:

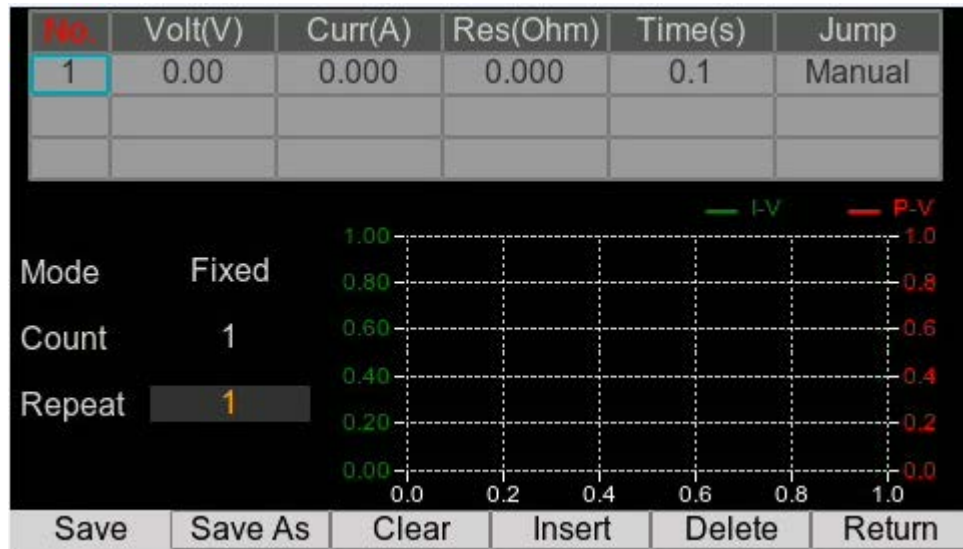

1. Press the left and right arrow keys or turn the knob to select the edit cell of Volt, and press the **[Enter]** key.
2. Set parameters such as voltage and current, and press **[Enter]**.

Volt	Voltage value of a single Step
Curr	Current value of a single Step
Res	Resistance value of a single Step
Time	Single Step pulse width, setting range: 0.1-10, unit: second, resolution: 0.1s. This parameter takes effect only when Jump is set to Time mode.
Jump	Specify the jump mode of the Step. <ul style="list-style-type: none"> ● Setting it to Manual means manually triggering the execution of the next Step. Take the Trigger

	<p>Source set to Manual triggering as an example, when a Step is executed, the [Next] button must be pressed to execute the next Step.</p> <ul style="list-style-type: none"> Setting it to Time means that the Time (pulse width) of each Step is executed and the next Step will be executed automatically.
--	--

- After editing the waveform parameters, press the **[Esc]** key to move the cursor (blue box) to the position shown in the figure below.

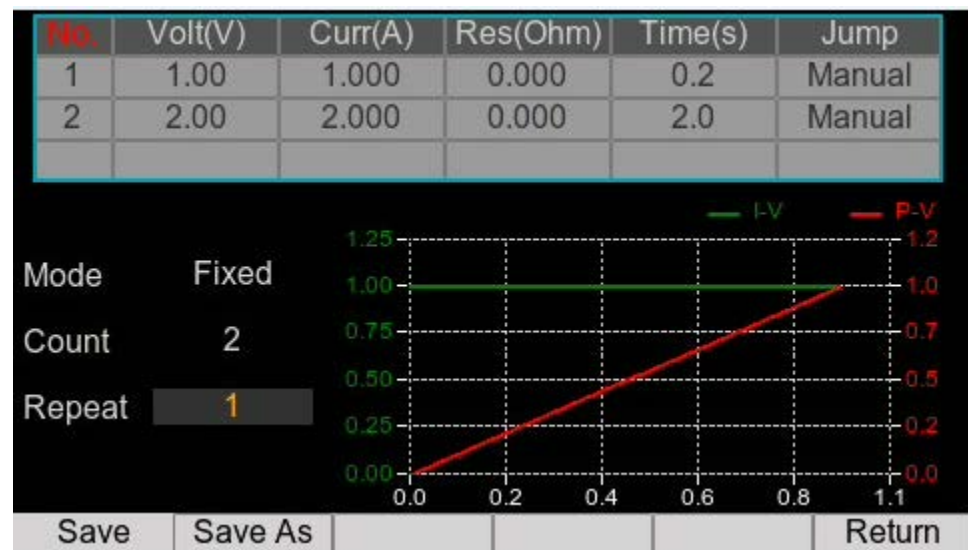

- Turn the knob or press the left/right arrow keys to select **Repeat**, and press **[Enter]** to set the number of cycles.

Repeat: Program cycle times, setting range: 1~65535.

- After editing the parameters, press **[Save As]** to select the address to be saved in the instrument or to an external U disk.
- Press **[Return]** to return to the main Program interface, and press **[Open]** to enter the Program file storage area.
- Turn the knob, select the previously edited Program file, and press **[Enter]** to load.
- Press the **[Run]** key to run the selected Program file.

At this time, the Program waiting to be triggered mark appears on the top of the screen.

- Turn on **[On/Off]**.

At this point, the instrument outputs according to the setting of the first Step of the Program.

Note: If the DUT has been connected at this time, pay attention to whether the set voltage and current values match the actual test

requirements.

- According to the set **Trigger Source**, trigger the Program to run.

User Program



Press the **[Edit]** button to enter the following interface:

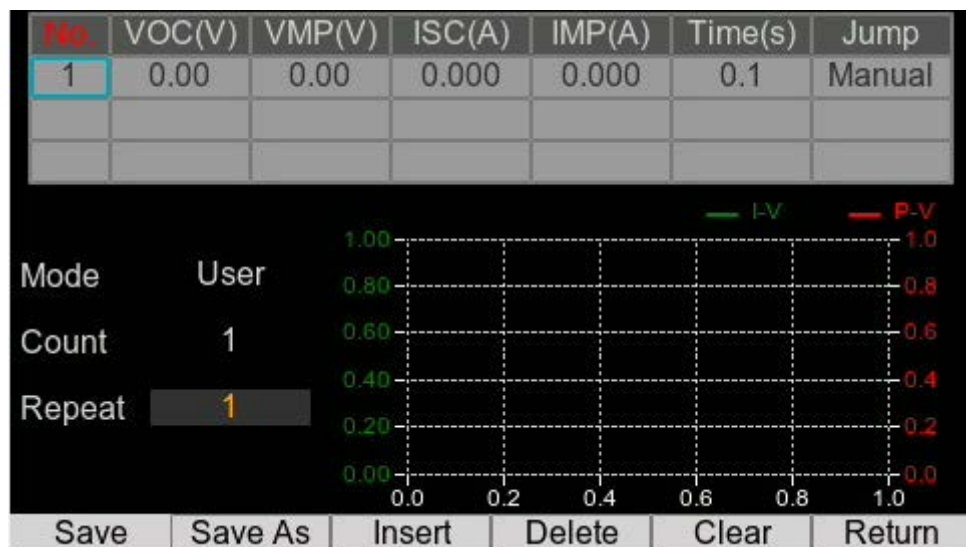

- Press the left and right arrow keys or turn the knob to select the VOC edit cell and press **[Enter]**.
- Set parameters such as VOC and VMP, and press **[Enter]**.

VOC	Open circuit voltage of a single step
-----	---------------------------------------

VMP	VMP of a single step
ISC	ISC of a single step
IMP	IMP of a single step
Time	<p>Single Step pulse width, setting range: 0.1-10, unit: second, resolution: 0.1s.</p> <p>This parameter takes effect only when Jump is set to Time mode.</p>
Jump	<p>Specify the jump mode of the Step.</p> <ul style="list-style-type: none"> ● Setting it to Manual means manually triggering the execution of the next Step. Take the Trigger Source set to Manual triggering as an example, when a Step is executed, the [Next] button must be pressed to execute the next Step. ● Setting it to Time means that the Time (pulse width) of each Step is executed and the next Step will be executed automatically.

- After editing the waveform parameters, press the **[Esc]** key to move the cursor (blue box) to the position shown in the figure below.



- Turn the knob or press the left/right arrow keys to select **Repeat**, and press **[Enter]** to set the number of cycles.

Repeat: Program cycle times, setting range: 1~65535.

5. After editing the parameters, press **[Save As]** to select the address to be saved in the instrument or to an external U disk.
6. Press **[Return]** to return to the main Program interface, and press **[Open]** to enter the Program file storage area.
7. Turn the knob, select the previously edited Program file, and press **[Enter]** to load.
8. Press the **[Run]** key to run the selected Program file.

At this time, the Program waiting to be triggered mark appears on the top of the screen.

9. Turn on **[On/Off]**.

At this point, the instrument outputs according to the setting of the first Step of the Program.

Note: If the DUT has been connected at this time, pay attention to whether the set voltage and current values match the actual test requirements.

10. According to the set **Trigger Source**, trigger the Program to run.

Curve Program



Press the **[Edit]** button to enter the following interface:



1. Press the left and right arrow keys or turn the knob to select the **Reg** edit cell and press **[Enter]**.
2. Set parameters such as regulations and materials, and press **[Enter]**.

Reg	Regulation settings for a single Step
VMP	VMP settings for a single Step
PMP	PMP settings for a single Step
Material	Material settings for a single Step
Time	<p>Single Step pulse width, setting range: 0.1-10, unit: second, resolution: 0.1s.</p> <p>This parameter takes effect only when Jump is set to Time mode.</p>
Jump	<p>Specify the jump mode of the Step.</p> <ul style="list-style-type: none"> ● Setting it to Manual means manually triggering the execution of the next Step. Take the Trigger Source set to Manual triggering as an example, when a Step is executed, the [Next] button must be pressed to execute the next Step. ● Setting it to Time means that the Time (pulse width) of each Step is executed and the next Step will be executed automatically.

- After editing the waveform parameters, press the **[Esc]** key to move the cursor (blue box) to the position shown in the figure below.



- Turn the knob or press the left/right arrow keys to select **Repeat**, and press **[Enter]** to set the number of cycles.

Repeat: Program cycle times, setting range: 1~65535.

- After editing the parameters, press **[Save As]** to select the address to be saved in the instrument or to an external U disk.
- Press **[Return]** to return to the main Program interface, and press **[Open]** to enter the Program file storage area.
- Turn the knob, select the previously edited Program file, and press **[Enter]** to load.
- Press the **[Run]** key to run the selected Program file.

At this time, the Program waiting to be triggered mark appears on the top of the screen.

- Turn on **[On/Off]**.

At this point, the instrument outputs according to the setting of the first Step of the Program.

Note: If the DUT has been connected at this time, pay attention to whether the set voltage and current values match the actual test requirements.

- According to the set **Trigger Source**, trigger the Program to run.

Table Program



Press the **[Edit]** button to enter the following interface:

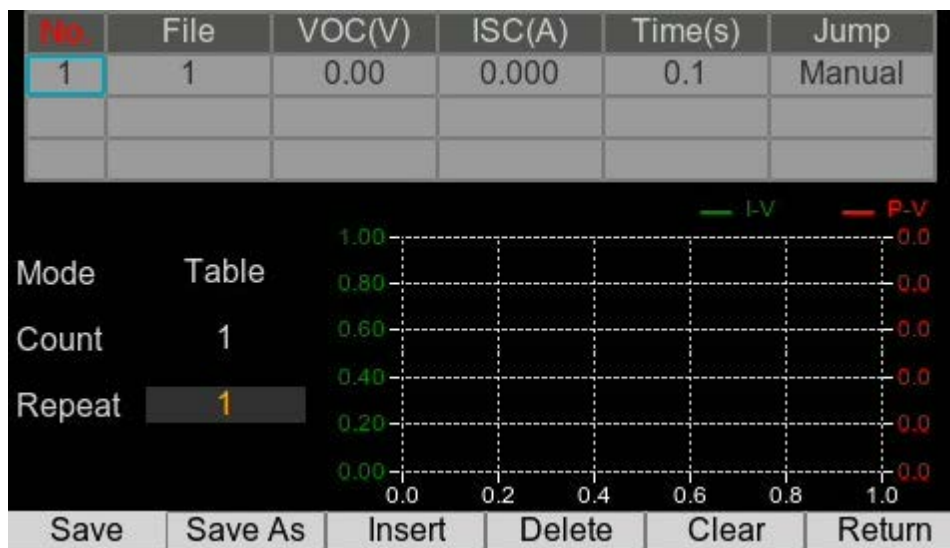

1. Press the left and right arrow keys or turn the knob to select the cell of **File** and press **[Enter]**.
2. Set parameters such as File and VOC, and press **[Enter]**.

File	Recall the saved Table file
VOC	VOC of a single Step
ISC	ISC of a single Step

Time	<p>Single Step pulse width, setting range: 0.1-10, unit: second, resolution: 0.1s.</p> <p>This parameter takes effect only when Jump is set to Time mode.</p>
Jump	<p>Specify the jump mode of the Step.</p> <ul style="list-style-type: none"> Setting it to Manual means manually triggering the execution of the next Step. Take the Trigger Source set to Manual triggering as an example, when a Step is executed, the [Next] button must be pressed to execute the next Step. Setting it to Time means that the Time (pulse width) of each Step is executed and the next Step will be executed automatically.

- After editing the waveform parameters, press the **[Esc]** key to move the cursor (blue box) to the position shown in the figure below.

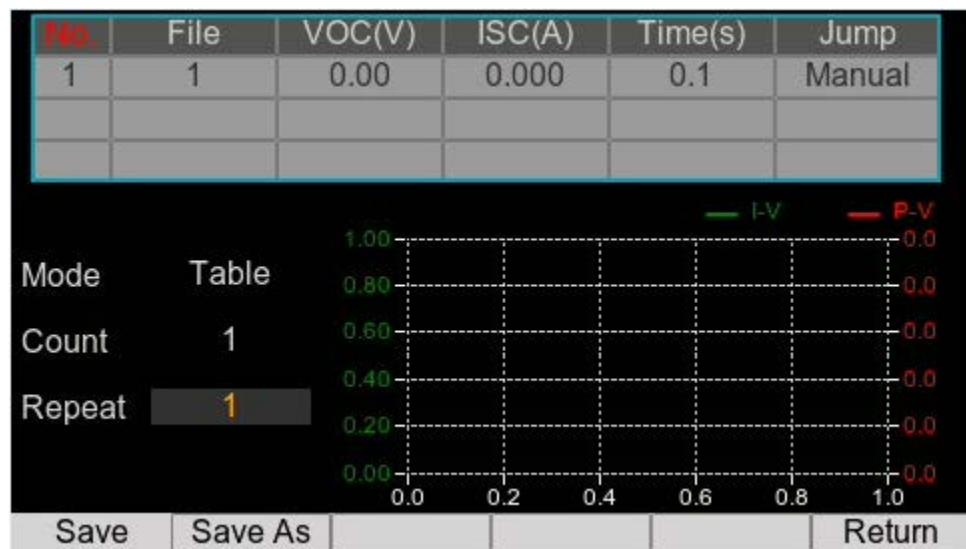

- Turn the knob or press the left/right arrow keys to select **Repeat**, and press **[Enter]** to set the number of cycles.
Repeat: Program cycle times, setting range: 1~65535.
- After editing the parameters, press **[Save As]** to select the address to be saved in the instrument or to an external U disk.
- Press **[Return]** to return to the main Program interface, and press **[Open]** to enter the Program file storage area.
- Turn the knob, select the previously edited Program file, and press **[Enter]**

to load.

8. Press the **[Run]** key to run the selected Program file.

At this time, the Program waiting to be triggered mark appears on the top of the screen.

9. Turn on **[On/Off]**.

At this point, the instrument outputs according to the setting of the first Step of the Program.

Note: If the DUT has been connected at this time, pay attention to whether the set voltage and current values match the actual test requirements.

10. According to the set **Trigger Source**, trigger the Program to run.

3.9 Factory Interface

Factory is the factory menu, which is used for troubleshooting and problem analysis. Please operate under the guidance of ITECH technical support.

3.10 Protect Interface

IT-N2100 series power supplies support comprehensive protection functions, **[Shift] + [2] (Protect)** interface is introduced as follows:

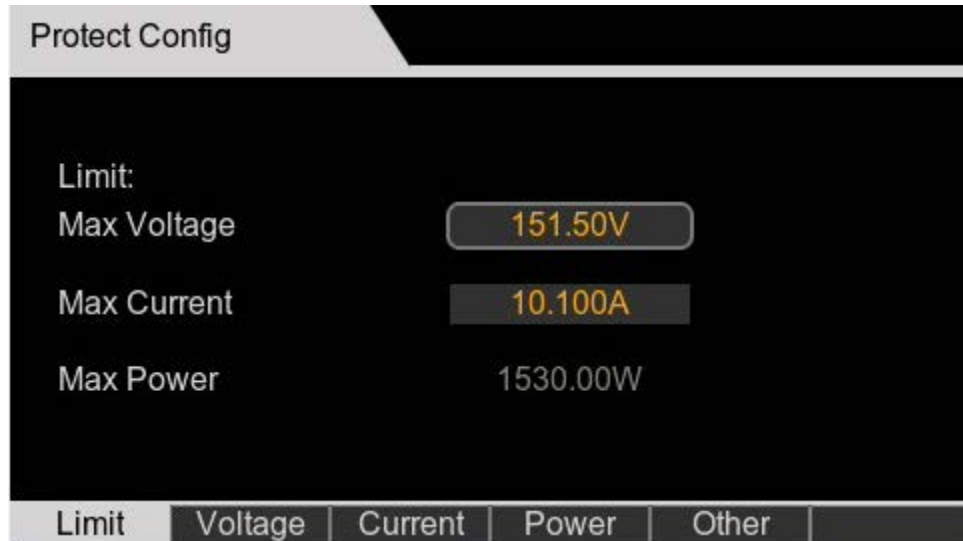

Limit	Setting the limit value of voltage and current can avoid wrong setting of output voltage and output current in any interface.	
	Max Voltage: voltage limit value Max Current: current limit value	
Voltage	Set the overvoltage protection for the voltage.	
	OVP	OVP function

		Off	Disable the OVP function (Def)	
		On	Enable the OVP function	
		Value	OVP protection point setting	
		Delay	Protection delay time. Setting range: 0.000~10s, step 0.001s, default 10s	
Current	Set overcurrent or undercurrent protection.			
	OCP	Overcurrent protection function		
		Off	Disable the OCP function (Def)	
		On	Enable the OCP function	
		Value	OCP protection point setting	
		Delay	Protection delay time. Setting range: 0.000~10s, step 0.0001s, default 10s.	
	UCP	Undercurrent protection function		
		Off	Disable the UCP function (Def)	
		On	Enable the UCP function	
		Warm	The instrument warm-up time, which is set to prevent the current from reaching the protection value during the rising process and triggering the protection state. Because this transient condition should not be considered an undercurrent fault, and there is no need to trigger the protection mechanism. Setting range: 0.00~30s, step 0.01s, default 30s	
		Value	UCP protection point setting	
	Delay	Protection delay time. Setting range: 0.000~10s, step 0.0001s, default 10s.		
Power	OPP	Over power protection function		
		Off	Disable the OPP function (Def)	
		On	Enable the OPP function	
			Value	OPP protection point setting

			Delay	Protection delay time. Setting range: 0.000~10s, step 0.001s, default 10s
Other	Fold Back	Foldback protection function. Default is Off. <ul style="list-style-type: none"> ● If CC is selected, it means that when the operating mode of the instrument is switched from CV mode to CC mode, the instrument triggers the protection and the output is OFF. After selecting CC, you also need to set the protection delay time. Setting range: 0.000~9.999s, step 0.001s, default 0s. ● If CV is selected, it means that when the operation mode of the instrument is switched from CC mode to CV mode, the instrument triggers the protection and the output is OFF. After selecting CV, it is also necessary to set the protection delay time. Setting range: 0.000~9.999s, step 0.001s, default 0s. ● Select Off to disable the foldback protection function. 		
	Inhibit Set	Inhibit output mode setting. Default is Off. <ul style="list-style-type: none"> ● Select Latch, when the Inhibit pin on the rear panel receives a low-level signal, the output is off, and even if the pin receives a high-level signal, the output will not be restored, and must be manually turned on [On/Off]. ● Select Living, when the Inhibit pin on the rear panel receives a low-level signal, the output is off, and when it receives a high-level signal, the output is resumed. ● If Off is selected, the output state is not controlled by the Inhibit pin on the rear panel. 		

3.11 Trigger Function

Set Trigger Source

Menu > System > General > Trigger Source, this option is used to set whether the trigger signal is keyboard trigger, command trigger or external signal trigger during Program operation.

- If the option is **Manual** (default), the trigger signal is provided by the panel compound keys **[Shift] + [5]** (Trigger);
- If the option is **Bus**, it is command trigger mode (***TRG** command trigger);
- If the option is **External**, it is the external signal trigger mode, that is, if the Trig terminal on the rear panel receives a **low-level** signal once, it will

trigger a Program operation.

Set the Signal Direction of the Trig Pin

Menu > System > General > Trigger Port, this option is used to set the signal direction of the Trig pin.

- **Out:** The signal direction of the Trig pin is the output signal, that is, when the instrument receives the panel key trigger or command trigger, it outputs a low-level signal through the Trig pin.
- **In:** The signal direction of the Trig pin is the input signal, that is, when the Trig pin receives a low-level trigger signal, the instrument performs a trigger operation.

This function is applicable to the Program synchronization trigger of multiple IT-N2100, please refer to the following wiring.

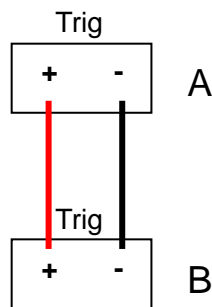

For example, the Trigger Port of Power A is set to Out, and the Trigger Source is Manual, the Trigger Port of Power B is set to In, and the Trigger Source is External. On the panel of power supply A, the **[Shift] + [5]** (Trigger) button triggers the execution of the Program of power supply A. At this time, the Trig pin of power supply A outputs a low-level signal, which triggers the running of the Program of power supply B.

3.12 Inner Load Switch Settings

When **Menu > System > Source > Leak Circuit** set to **ON** (default), it means that the inner load is turned on, and the Meter voltage will quickly drop to 0 after the output is Off. When the output voltage is within 30V, the absorption current is about 200mA, and if the output voltage is above 30V, the power absorption is about 10W.

When set to **Off**, it means to turn off the internal load, the Meter voltage will slowly drop to 0 after the output is Off.

If the DUT is a battery and Leak Circuit is set to ON, the power supply will discharge the battery with a current of about 200mA when the power supply is still connected to the battery after the output is OFF. Please disconnect the DUT and the power supply in time to avoid continuously discharging the battery.

3.13 Keyboard Lock Function

The instrument panel keys can be locked by the compound keys **[Shift] + [6]** (Lock) on the panel. At this time, the LOCK icon will be displayed at the top of the screen. Except for the **[Shift]** key, all other keys are disabled, press this compound key again to cancel the lock.

3.14 Rear Panel Terminal Functions

Inhibit Function

Inhibit the output interface, short the Inhibit+ and Inhibit– interfaces to disable the power output.  icon appears.

Menu > Protect > Other > Inhibit Set in Living mode, to restore, remove the wire between Inhibit+ and Inhibit–.

Menu > Protect > Other > Inhibit Set in Latch mode, to restore, remove the wire between Inhibit+ and Inhibit– and manually turn on **[ON/OFF]**.

Trigger Function

External trigger signal output and input interface, when **Menu > System > General > Trigger Port** is in **In** state, it can receive a low-level pulse signal as a trigger source; when in **Out** state, when a trigger event occurs, the instrument can output a low-level pulse trigger signal.

Chapter 4 Remote Control

IT-N2100 series power supplies have two built-in communication interfaces: USB and LAN. The user can choose any one to communicate with the computer.

4.1 USB Interface

The USB interface is located on the rear panel of the instrument, and the user can connect the instrument and the computer through a cable with both USB ports (one end is USB A type interface and the other end is USB B type interface).

This series of power supply USB interfaces include the following two types, which do not need to be set in the menu, and can be operated remotely after installing the driver and connecting the USB communication cable.

- **TMC:** USB_TMC type interface, you need to install the NI-VISA driver adapted to the computer operating system version. Please download the driver from the NI official website. After the driver is installed successfully, it will be recognized as the USB device address in the computer device manager.
- **VCP:** Virtual serial port. The Win7 version of the operating system needs to install the supporting driver. Please download the driver from the ITECH official website or contact the ITECH technical support personnel to obtain it. The operating system of Win10 and above does not need to install the driver. Recognized as a COM port in the computer's device manager.

4.2 LAN Interface

When the user uses the LAN interface to communicate with the PC, the user should refer to the following contents to connect and configure the LAN interface. The LAN interface of this instrument conforms to the LXI standard.

Connection Interface

Connecting the Interface Use the following steps to quickly connect the instrument to a local area network and configure it. Two typical LAN interface systems are described below: private network and site network.

- **Connect to private LAN**

A private LAN is a network in which LAN-enabled instruments and computers are directly connected. They are typically small, with no centrally managed resources. When connected to a computer, a standard network cable can be used to connect directly to the computer via the LAN interface.

- **Connect to site LAN**

A site LAN is a local area network in which LAN-enabled instruments and computers are connected to the network through routers, hubs, and/or switches. They are typically large, centrally-managed networks with services such as DHCP and DNS servers. When connected to a computer,

a network cable can be used to connect to the router, and the computer is also connected to the router.



Note

When using one crossover cable to connect PC directly, the gateway address of the instrument should be consistent with that of the PC, and the IP address should be at the same network segment with the PC's IP address.

When the instrument and computer are connected to the router, an independent IP address must be assigned for the instrument.

Configure LAN Interface Parameters

This series of power supplies supports the configuration of the following LAN communication parameters:

- **MODE: Set IP mode**
 - Automatically configure instrument address (Auto): Automatically configure the default IP address.
 - Manually configure the instrument address (Manual): The method is to set the following parameters of the instrument, the settings of these parameter values are only displayed when Manual is selected.
- **IP:** This value is the Internet Protocol (IP) address of the instrument. An IP address is required for all IP and TCP/IP communications with the instrument. An IP Address consists of 4 decimal numbers separated by periods. Each decimal number ranges from 0 through 255 with no leading zeros (for example, 169.254.2.20).
- **Gateway:** This value is the IP Address of the default gateway that allows the instrument to communicate with systems that are not on the local subnet, as determined by the subnet mask setting. The same numbering notation applies as for the IP Address. A value of 0.0.0.0 indicates that no default gateway is defined.
- **Mask:** This value is used to enable the instrument to determine if a client IP address is on the same local subnet. The same numbering notation applies as for the IP Address. When a client IP address is on a different subnet, all packets must be sent to the Default Gateway.
- **PORT:** This value indicates the port number corresponding to the service, which is fixed at 30000.

The configuration steps are as follows:

1. Press the **[Menu]** key to enter the Menu interface.
2. Rotate the knob, select System, and press **[Enter]** to confirm.
3. Press the button corresponding to Lan at the bottom of the screen.
4. Rotate the knob, select Mode, press **[Enter]** to confirm, and select IP setting mode.
 - Auto: Automatic mode, which can automatically set the address of the instrument;
 - Manual: Manual mode, you can manually set the address of the instrument. If Manual is selected, you need to set the IP, Gateway, Mask parameter values.

The IP address needs to be configured to be on the same network segment as the computer.

Gateway and Mask must be the same as the computer configuration.

5. After the configuration is complete, press the **[Esc]** key to return.

Chapter 5 Technical Specification

This chapter will introduce the main technical parameters such as rated voltage, rated current and rated power of the IT-N2100 power supply, as well as the storage environment and temperature of the power supply.

5.1 Main Technical Parameters

IT-N2121

Parameter	IT-N2121		
Rated values	Voltage	0 - 80V	Voc 95V
	Current	0 - 25A	
	Power	0 - 800W	
	Resistance	0 - 9.999Ω	
Line regulation ±(%of Output+Offset)	Voltage	≤0.01%+2mV	Sense mode
	Current	≤0.01%+1.5mA	
Load regulation ±(%of Output+Offset)	Voltage	≤0.01%+2mV	Sense mode
	Current	≤0.01%+1mA	
Setup resolution	Voltage	10mV	
	Current	1mA	
	Power	/	
	Resistance	/	
Readback resolution	Voltage	1mV	
	Current	1mA	
	Power	/	
Setup accuracy	Voltage	≤0.03%+20mV	
	Current	≤0.05%+10mA	
	Power	/	
	Resistance	/	
Readback accuracy	Voltage	≤0.03%+15mV	
	Current	≤0.05%+8mA	
	Power	/	
Ripple (20hz-20Mhz)	Voltage	≤300mVp-p/≤40mVrms	
Ripple (20hz-300Khz)	Voltage RMS	40mVrms	
	Current RMS	≤8mArms	30mA _{p-p}
Setup Temp.coefficient (%of Output+Offset)/°C	Voltage	≤0.003%+1mV	
	Current	≤0.015%+0.27mA	
Readback	Voltage	≤0.002%+0.8mV	

Temp.coefficient (%of Output+Offset)/°C	Current	$\leq 0.012\% + 0.27\text{mA}$	
Rise time(No-load)	Voltage	$\leq 20\text{ms}$	The voltage rise and fall time refers to the change of the set value, the set value is 1%-100% or 100%-1%
Rise time(Full-load)	Voltage	$\leq 20\text{ms}$	The current rise and fall time refers to the change of the set value, set value 1%-100% or 100%-1%
Fall time(No-load)	Voltage	$\leq 20\text{ms}$	Current rise time $\leq 50\mu\text{s}$ 10%-90%
Fall time(Full-load)	Voltage	$\leq 20\text{ms}$	Current drop time $\leq 50\mu\text{s}$ 10%-90%
Transient response time	Voltage	150us	50%-100% load recovery to 100mV
AC input	Voltage	220V/110V	
	Frequency	50/60Hz	
Setup stability -30min (%of Output +Offset)	Voltage	$\leq 0.01\% + 1\text{mV}$	
	Current	$\leq 0.02\% + 1.5\text{mA}$	
Setup stability -8h (%of Output +Offset)	Voltage	$\leq 0.015\% + 1.2\text{mV}$	
	Current	$\leq 0.02\% + 2\text{mA}$	
Readback stability -30min (%of Output +Offset)	Voltage	$\leq 0.01\% + 1\text{mV}$	
	Current	$\leq 0.02\% + 1.5\text{mA}$	
Readback stability -8h (%of Output +Offset)	Voltage	$\leq 0.015\% + 1.2\text{mV}$	
	Current	$\leq 0.02\% + 2\text{mA}$	
Efficiency		60% (Typical)	
Remote Sense Compensation		$\leq 2\text{V}$	
Command Response		$\leq 15\text{ms}$	
Power Factor		≥ 0.98	
Maximum input current		11A	
Maximum input apparent power		1100VA	
Storage temperature		-10°C - 70°C	
Protective function		OVP/OCP	
Communication Interface		LAN/USB	
Isolation (output to ground)		1500Vdc	
Isolation (input to ground)		1500Vac	
Working temperature		0 - 40°C	

Fuse Specifications	T15A	The fuse is inside the power supply
Number of parallel machines	Not Support	
Number of machines in series	No limit	The output terminal common mode voltage does not exceed 1500VDC
Protection class	IP20	
Safety Regulation	IEC 61010	
Cooling Style	Fans	
Dimension (Removal handle, etc., assembly dimensions)	450 mm (D) x 214 mm (W) x 88.2 mm(H)	
Dimension(Overall)	529.5 mm (D) x 255 mm (W) x 108.2 mm(H)	
Weight (net weight)	9kg	

Supplementary Note

	Parameter	Remark	
IO	Voltage input range of IO ports	0~5V	
	IO input pin source and sink I _{MAX}	47mA	
	Voltage output range of IO ports	0~5V	
	IO output pin source and sink I _{MAX}	0.45mA	
	IO port response time	10ms	Minimum action time, from given signal to trigger action
	IO port to output DC	<15V	The damage is short circuit, the maximum current is 1A
LIST	LIST bandwidth	-	
	Voltage/Current Step Resolution	1mV 1mA	
	Signal rise and fall time range	1mS~3600S	The actual effect refers to the rise/fall time of the specification, here is the range of setting items
	Maximum number of steps	100	
	Maximum number of files	20	
	Number of GROUP	-	No group function
	Time accuracy	≤10ms/Step	
METER	Sampling Rate	1kHz±1%	
	Storage depth	500pts	

IT-N2123

Parameter		IT-N2123	
Rated values	Voltage	0 - 150V	Voc 165V
	Current	0 - 10A	
	Power	0 - 800W	
	Resistance	/	
Line regulation ±(%of Output+Offset)	Voltage	≤0.01%+2mV	Sense mode
	Current	≤0.01%+1mA	
Load regulation ±(%of Output+Offset)	Voltage	≤0.01%+3mV	Sense mode
	Current	≤0.01%+1mA	
Setup resolution	Voltage	10mV	
	Current	1mA	
	Power	/	
	Resistance	/	
Readback resolution	Voltage	1mV	
	Current	1mA	
	Power	/	
Setup accuracy	Voltage	≤0.03%+30mV	
	Current	≤0.05%+5mA	
	Power	/	
	Resistance	/	
Readback accuracy	Voltage	≤0.03%+20mV	
	Current	≤0.05%+5mA	
	Power	/	
Ripple (20hz-20Mhz)	Voltage	≤300mVp-p/≤40mVrms	
Ripple (20hz-300Khz)	Voltage RMS	40mVrms	
	Current RMS	≤5mArms	20mA _{p-p}
Setup Temp.coefficient (%of Output+Offset)/°C	Voltage	≤0.003%+1.5mV	
	Current	≤0.015%+0.35mA	
Readback Temp.coefficient (%of Output+Offset)/°C	Voltage	≤0.002%+1mV	
	Current	≤0.012%+0.35mA	
Rise time(No-load)	Voltage	≤20ms	The voltage rise and fall time refers to the change of the set value, the set value is 1%-100% or 100%-1%
Rise time(Full-load)	Voltage	≤20ms	The current rise and fall time refers to the change of the set value, set value 1%-100% or 100%-1%

Fall time(No-load)	Voltage	≤20ms	Current rise time ≤ 30us 10%-90%
Fall time(Full-load)	Voltage	≤20ms	Current drop time ≤ 30us 10%-90%
Transient response time	Voltage	150us	50%-100% load recovery to 100mV
AC input	Voltage	220V/110V	
	Frequency	50/60Hz	
Setup stability -30min (%of Output +Offset)	Voltage	≤0.01%+1mV	
	Current	≤0.02%+1.5mA	
Setup stability -8h (%of Output +Offset)	Voltage	≤0.015%+1.2mV	
	Current	≤0.02%+2mA	
Readback stability -30min (%of Output +Offset)	Voltage	≤0.01%+1mV	
	Current	≤0.02%+1.5mA	
Readback stability -8h (%of Output +Offset)	Voltage	≤0.015%+1.2mV	
	Current	≤0.02%+2mA	
Efficiency		72% (Typical)	
Remote Sense Compensation		≤2V	
Command Response		≤15ms	
Power Factor		≥0.98	
Maximum input current		11A	
Maximum input apparent power		1100VA	
Storage temperature		-10°C - 70°C	
Protective function		OVP/OCP	
Communication Interface		LAN/USB	
Isolation (output to ground)		1500Vdc	
Isolation (input to ground)		1500Vac	
Working temperature		0 - 40°C	
Fuse Specifications		T15A	The fuse is inside the power supply
Number of parallel machines		Not Support	
Number of machines in series		No limit	The output terminal common mode voltage does not exceed 1500VDC
Protection class		IP20	
Safety Regulation		IEC 61010	
Cooling Style		Fans	
Dimension (Removal handle, etc., assembly dimensions)		450 mm (D) x 214 mm (W) x 88.2 mm(H)	

Dimension(Overall)	529.5 mm (D) x 255 mm (W) x 108.2 mm(H)
Weight (net weight)	9kg

Supplementary Note

	Parameter		Remark
IO	Voltage input range of IO ports	0~5V	
	IO input pin source and sink I _{MAX}	47mA	
	Voltage output range of IO ports	0~5V	
	IO output pin source and sink I _{MAX}	0.45mA	
	IO port response time	10ms	Minimum action time, from given signal to trigger action
	IO port to output DC	<15V	The damage is short circuit, the maximum current is 1A
LIST	LIST bandwidth	-	
	Voltage/Current Step Resolution	1mV 1mA	
	Signal rise and fall time range	1mS~3600S	The actual effect refers to the rise/fall time of the specification, here is the range of setting items
	Maximum number of steps	100	
	Maximum number of files	20	
	Number of GROUP	-	No group function
	Time accuracy	≤10ms/Step	
METER	Sampling Rate	1kHz±1%	
	Storage depth	500pts	

IT-N2131

Parameter	IT-N2131		
Rated values	Voltage	0 - 80V	Voc 95V
	Current	0 - 25A	
	Power	0 - 1500W	1500W-220ac; 850W-110ac
	Resistance	0 - 9.999Ω	
Line regulation ±(%of Output+Offset)	Voltage	≤0.01%+2mV	Sense mode
	Current	≤0.01%+1.5mA	
Load regulation ±(%of Output+Offset)	Voltage	≤0.01%+2mV	Sense mode
	Current	≤0.01%+1mA	

Setup resolution	Voltage	10mV	
	Current	1mA	
	Power	/	
	Resistance	/	
Readback resolution	Voltage	1mV	
	Current	1mA	
	Power	/	
Setup accuracy	Voltage	$\leq 0.03\% + 20\text{mV}$	
	Current	$\leq 0.05\% + 10\text{mA}$	
	Power	/	
	Resistance	/	
Readback accuracy	Voltage	$\leq 0.03\% + 15\text{mV}$	
	Current	$\leq 0.05\% + 8\text{mA}$	
	Power	/	
Ripple (20hz-20Mhz)	Voltage	$\leq 300\text{mVp-p} / \leq 40\text{mVrms}$	
Ripple (20hz-300Khz)	Voltage RMS	40mVrms	
	Current RMS	$\leq 10\text{mA rms}$	40mA _{p-p}
Setup Temp.coefficient (%of Output+Offset)/°C	Voltage	$\leq 0.003\% + 1\text{mV}$	
	Current	$\leq 0.015\% + 0.27\text{mA}$	
Readback Temp.coefficient (%of Output+Offset)/°C	Voltage	$\leq 0.002\% + 0.8\text{mV}$	
	Current	$\leq 0.012\% + 0.27\text{mA}$	
Rise time(No-load)	Voltage	$\leq 20\text{ms}$	The voltage rise and fall time refers to the change of the set value, the set value is 1%-100% or 100%-1%
Rise time(Full-load)	Voltage	$\leq 20\text{ms}$	The current rise and fall time refers to the change of the set value, set value 1%-100% or 100%-1%
Fall time(No-load)	Voltage	$\leq 20\text{ms}$	Current rise time $\leq 50\mu\text{s}$ 10%-90%
Fall time(Full-load)	Voltage	$\leq 20\text{ms}$	Current drop time $\leq 50\mu\text{s}$ 10%-90%
Transient response time	Voltage	400us	50%-100% load recovery to 100mV
AC input	Voltage	220V/110V	
	Frequency	50/60Hz	
Setup stability -30min	Voltage	$\leq 0.01\% + 1\text{mV}$	

(%of Output +Offset)	Current	$\leq 0.02\% + 1.5\text{mA}$	
Setup stability -8h (%of Output +Offset)	Voltage	$\leq 0.015\% + 1.2\text{mV}$	
	Current	$\leq 0.02\% + 2\text{mA}$	
Readback stability -30min (%of Output +Offset)	Voltage	$\leq 0.01\% + 1\text{mV}$	
	Current	$\leq 0.02\% + 1.5\text{mA}$	
Readback stability -8h (%of Output +Offset)	Voltage	$\leq 0.015\% + 1.2\text{mV}$	
	Current	$\leq 0.02\% + 2\text{mA}$	
Efficiency		60% (Typical)	
Remote Sense Compensation		$\leq 2\text{V}$	
Command Response		$\leq 15\text{ms}$	
Power Factor		≥ 0.98	
Maximum input current		11A	
Maximum input apparent power		2100VA	
Storage temperature		$-10^{\circ}\text{C} - 70^{\circ}\text{C}$	
Protective function		OVP/OCP	
Communication Interface		LAN/USB	
Isolation (output to ground)		1500Vdc	
Isolation (input to ground)		1500Vac	
Working temperature		$0 - 40^{\circ}\text{C}$	
Fuse Specifications		T15A	The fuse is inside the power supply
Number of parallel machines		Not Support	
Number of machines in series		No limit	The output terminal common mode voltage does not exceed 1500VDC
Protection class		IP20	
Safety Regulation		IEC 61010	
Cooling Style		Fans	
Dimension (Removal handle, etc., assembly dimensions)		450 mm (D) x 214 mm (W) x 88.2 mm(H)	
Dimension(Overall)		529.5 mm (D) x 255 mm (W) x 108.2 mm(H)	
Weight (net weight)		9kg	

	Parameter		Remark
IO	Voltage input range of IO ports	0~5V	
	IO input pin source and sink I _{MAX}	47mA	
	Voltage output range of IO ports	0~5V	
	IO output pin source and sink I _{MAX}	0.45mA	

	IO port response time	10ms	Minimum action time, from given signal to trigger action
	IO port to output DC	<15V	The damage is short circuit, the maximum current is 1A
LIST	LIST bandwidth	-	
	Voltage/Current Step Resolution	1mV 1mA	
	Signal rise and fall time range	1mS~3600S	The actual effect refers to the rise/fall time of the specification, here is the range of setting items
	Maximum number of steps	100	
	Maximum number of files	20	
	Number of GROUP	-	No group function
	Time accuracy	≤10ms/Step	
METER	Sampling Rate	1kHz±1%	
	Storage depth	500pts	

IT-N2133

Parameter		IT-N2133	
Rated values	Voltage	0 - 150V	Voc 165V
	Current	0 - 10A	
	Power	0 - 1500W	1500W-220ac; 850W-110ac
	Resistance	/	
Line regulation ±(% of Output+Offset)	Voltage	≤0.01%+2mV	Sense mode
	Current	≤0.01%+1mA	
Load regulation ±(% of Output+Offset)	Voltage	≤0.01%+3mV	Sense mode
	Current	≤0.01%+1mA	
Setup resolution	Voltage	10mV	
	Current	1mA	
	Power	/	
	Resistance	/	
Readback resolution	Voltage	1mV	
	Current	1mA	
	Power	/	
Setup accuracy	Voltage	≤0.03%+30mV	
	Current	≤0.05%+5mA	
	Power	/	
	Resistance	/	

Readback accuracy	Voltage	$\leq 0.03\% + 20\text{mV}$	
	Current	$\leq 0.05\% + 5\text{mA}$	
	Power	/	
Ripple (20hz-20Mhz)	Voltage	$\leq 300\text{mVp-p} / \leq 40\text{mVrms}$	
Ripple (20hz-300Khz)	Voltage RMS	40mVrms	
	Current RMS	$\leq 5\text{mA}_{\text{RMS}}$	20mA _{p-p}
Setup Temp.coefficient (%of Output+Offset)/°C	Voltage	$\leq 0.003\% + 1.5\text{mV}$	
	Current	$\leq 0.015\% + 0.35\text{mA}$	
Readback Temp.coefficient (%of Output+Offset)/°C	Voltage	$\leq 0.002\% + 1\text{mV}$	
	Current	$\leq 0.012\% + 0.35\text{mA}$	
Rise time(No-load)	Voltage	$\leq 20\text{ms}$	The voltage rise and fall time refers to the change of the set value, the set value is 1%-100% or 100%-1%
Rise time(Full-load)	Voltage	$\leq 20\text{ms}$	The current rise and fall time refers to the change of the set value, set value 1%-100% or 100%-1%
Fall time(No-load)	Voltage	$\leq 20\text{ms}$	Current rise time $\leq 30\mu\text{s}$ 10%-90%
Fall time(Full-load)	Voltage	$\leq 20\text{ms}$	Current drop time $\leq 30\mu\text{s}$ 10%-90%
Transient response time	Voltage	300us	50%-100% load recovery to 100mV
AC input	Voltage	220V/110V	
	Frequency	50/60Hz	
Setup stability -30min (%of Output +Offset)	Voltage	$\leq 0.01\% + 1\text{mV}$	
	Current	$\leq 0.02\% + 1.5\text{mA}$	
Setup stability -8h (%of Output +Offset)	Voltage	$\leq 0.015\% + 1.2\text{mV}$	
	Current	$\leq 0.02\% + 2\text{mA}$	
Readback stability -30min (%of Output +Offset)	Voltage	$\leq 0.01\% + 1\text{mV}$	
	Current	$\leq 0.02\% + 1.5\text{mA}$	
Readback stability -8h (%of Output +Offset)	Voltage	$\leq 0.015\% + 1.2\text{mV}$	
	Current	$\leq 0.02\% + 2\text{mA}$	
Efficiency		72% (Typical)	
Remote Sense Compensation		$\leq 2\text{V}$	
Command Response		$\leq 15\text{ms}$	
Power Factor		≥ 0.98	
Maximum input current		11A	
Maximum input		2100VA	

apparent power		
Storage temperature	-10°C - 70°C	
Protective function	OVP/OCP	
Communication Interface	LAN/USB	
Isolation (output to ground)	1500Vdc	
Isolation (input to ground)	1500Vac	
Working temperature	0 - 40°C	
Fuse Specifications	T15A	The fuse is inside the power supply
Number of parallel machines	Not Support	
Number of machines in series	No limit	The output terminal common mode voltage does not exceed 1500VDC
Protection class	IP20	
Safety Regulation	IEC 61010	
Cooling Style	Fans	
Dimension (Removal handle, etc., assembly dimensions)	450 mm (D) x 214 mm (W) x 88.2 mm(H)	
Dimension(Overall)	529.5 mm (D) x 255 mm (W) x 108.2 mm(H)	
Weight (net weight)	9kg	

	Parameter		Remark
IO	Voltage input range of IO ports	0~5V	
	IO input pin source and sink I _{MAX}	47mA	
	Voltage output range of IO ports	0~5V	
	IO output pin source and sink I _{MAX}	0.45mA	
	IO port response time	10ms	Minimum action time, from given signal to trigger action
	IO port to output DC	<15V	The damage is short circuit, the maximum current is 1A
LIST	LIST bandwidth	-	
	Voltage/Current Step Resolution	1mV 1mA	
	Signal rise and fall time range	1mS~3600S	The actual effect refers to the rise/fall time of the specification, here is the range of setting items
	Maximum number of steps	100	
	Maximum number of files	20	
	Number of GROUP	-	No group function
	Time accuracy	≤10ms/Step	

METER	Sampling Rate	1kHz±1%	
	Storage depth	500pts	

* This information is subject to change without notice.

5.2 Supplemental Characteristics

Recommended calibration frequency: once a year

Cooling style: fans

Appendix

Specifications of Red and Black Test Cables

ITECH provides you with optional red and black test cables, which are sold individually and you can select for test. For specifications of ITECH test cables and maximum current values, refer to the table below.

Model	Specifications	Cross-sectional area	Length
IT-E301/10A	10A	-	1m
IT-E301/30A	30A	6mm ²	1.2m
IT-E301/30A	30A	6mm ²	2m
IT-E301/60A	60A	20mm ²	1.5m
IT-E301/120A	120A	50mm ²	2m
IT-E301/240A	240A	70mm ²	1m
IT-E301/240A	240A	70mm ²	2m
IT-E301/360A	360A	95mm ²	2m

For maximum current of AWG copper wire, refer to table below.

AWG	10	12	14	16	18	20	22	24	26	28
maximum current value (A)	40	25	20	13	10	7	5	3.5	2.5	1.7

Note: AWG (American Wire Gage), it means X wire (marked on the wire). The table above lists current capacity of single wire at working temperature of 30°C. For reference only.

Contact Us

Thanks for purchasing ITECH products. In case of any doubts, please contact us as follows:

1. Visit ITECH website: www.itechate.com.
2. Select the most convenient contact method, for further information.