

TA150 350 MHz oscilloscope probe
TA133 500 MHz oscilloscope probe

User's Guide



Manufacturer

PMK Mess- und Kommunikationstechnik GmbH
Königsteiner Str. 98
D-65812 Bad Soden am Taunus
Germany

Sales and support

Pico Technology
James House
Colmworth Business Park
St. Neots PE19 8YP
United Kingdom

EC declaration of conformity

Pico Technology declares that the following products comply with the requirements of the specified Directives and Standards as listed below. Technical documentation required to demonstrate compliance to the standards is available for inspection by the relevant enforcement authorities. Products carry the CE mark.

Products covered by this declaration:

TA133	500 MHz oscilloscope probe
TA150	350 MHz oscilloscope probe

EU Directives covered by this declaration:

2006/95/EC	<i>Low Voltage Equipment Directive</i>
2012/19/EU	<i>Waste Electrical and Electronic Equipment</i>
2011/65/EU	<i>Restriction of use of certain Hazardous Substances</i>

The basis on which conformity is being declared:

EN61010-1:2010	<i>Safety requirements for electrical equipment for measurement, control and laboratory use, general equipment requirements.</i>
EN61010-031:2002 + A1:2008	<i>Safety requirements for hand-held probe assemblies for electrical measurement and test.</i>
RoHS and WEEE	<i>Manufacturer's analysis of the raw materials used in the manufacture of the above products.</i>

Your help and efforts are required to protect and keep our environment clean. Therefore either return this product at the end of life to the manufacturer or ensure WEEE compliant collection and treatment yourself. Do not dispose of as unsorted municipal waste.



Warranty

Pico Technology warrants this oscilloscope accessory for normal use and operation within specifications for a period of two years from date of shipment and will repair or replace any defective product which was not damaged by negligence, misuse, improper installation, accident or unauthorized repair or modification by the buyer. This warranty is applicable only to defects due to material or workmanship. Pico Technology disclaims any other implied warranties of merchantability or fitness for a particular purpose. Pico Technology will not be liable for any indirect, special, incidental, or consequential damages (including damages for loss of profits, loss of business, loss of use or data, interruption of business and the like), even if Pico Technology has been advised of the possibility of such damages arising from any defect or error in this manual or product.

Information in this publication supersedes that in all previously published material.

Pico Technology is a registered trade mark of Pico Technology Ltd.

Copyright © 2012–2015 Pico Technology Ltd. All rights reserved.

1. Safety

To prevent possible electrical shock, fire, personal injury, or damage to the product, carefully read this safety information before attempting to install or use the product. In addition, follow all generally accepted safety practices and procedures for working with and near electricity.

The product has been designed and tested in accordance with the European standard publication EN 61010-1:2010, and left the factory in a safe condition.





The following safety descriptions are found throughout this guide:

A **WARNING** identifies conditions or practices that could result in injury or death.

A **CAUTION** identifies conditions or practices that could result in damage to the product or equipment to which it is connected.

Symbols

These safety and electrical symbols may appear on the product or in this guide:

Symbol	Description
	Direct current
	Earth (ground) terminal
	Possibility of electric shock
	Caution
	Do not dispose of this product as unsorted municipal waste.

Terminal can be used to make a measurement ground connection. The terminal is NOT a Safety or protective Earth.

Appearance on the product indicates a need to read these safety and operation instructions.



WARNING

To prevent injury or death only qualified personnel should use this product, only as instructed and with only accessories supplied or recommended. Protection provided by the product may be impaired if used in a manner not specified by the manufacturer.

Maximum input ranges

The table and frequency derating plot below indicate the full-scale measurement range and overvoltage protection range for these probes. The full-scale measurement ranges are the maximum voltages that can be accurately measured by the probe. The overvoltage protection ranges are the maximum voltages that will not damage the probe.



WARNING

To prevent electric shock, do not connect the probe to voltages exceeding the levels below and do take all necessary safety precautions when working on equipment where hazardous live voltages may be present.

Model	Full-scale measurement range	Overvoltage protection (voltage that will not damage)
TA133 & TA150	400 V RMS (not in CAT II)	1250 V transient (not in CAT II)
	300 V RMS (CAT II)	

**WARNING**

To avoid overloading the probe, note that its maximum input voltage rating decreases as the frequency of the applied signal increases.

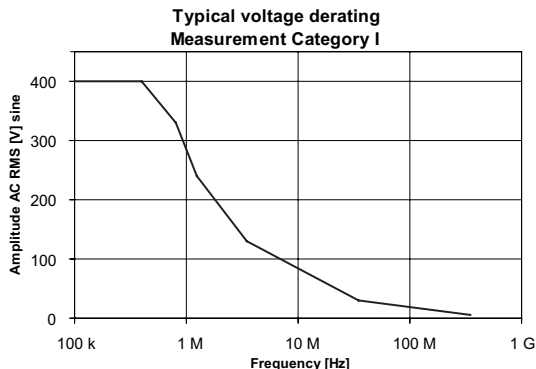

Measurement categories are defined in IEC 61010-031 as follows:

No Measurement Category (not in CAT II, III or IV)	
Definition	For measurements performed on circuits not directly connected to a mains supply.
Examples	Measurements in circuits not derived from a mains supply and specially protected (internal) circuits derived from a mains supply. In the latter case, transient stresses are variable; for that reason it is required that the transient withstand capability of the equipment is made known to the user.
Measurement Category II (CAT II)	
Definition	Measurement category II is for measurements performed on circuits directly connected to the low voltage installation.
Examples	Household appliances, portable tools and similar equipment.

Grounding**WARNING**

Never connect the ground input to, or allow it to touch, any electrical potential other than ground. To prevent personal injury or death, use a voltmeter to check that there is no significant AC or DC voltage between the probe ground and the point to which you intend to connect it.

**CAUTION**

Applying a voltage to the ground input is likely to cause permanent damage to the probe or other connected equipment.

It is good practice to connect the probe output to the measurement instrument and the ground lead to earth ground before connecting the probe to the circuit under test. Disconnect the probe input and the probe ground lead from the circuit under test before disconnecting the probe from the measurement instrument.

Environment



WARNING

To prevent injury or death, do not use near explosive gas or vapor.



CAUTION

To prevent damage to the probe, do not use in wet or damp conditions and always use and store your probe in appropriate environments.

	Storage	Operating
Temperature	-40 °C to +71 °C	0 °C to +50 °C
Max. humidity (non-condensing)	80 %	80 % to +31 °C, decreasing linearly to 40 % at +50 °C
Max. altitude	15 000 m	2000 m
Pollution degree	2 (As defined in IEC 61010-031. Only non-conductive pollution. Occasionally, however, a temporary conductivity caused by condensation must be accepted.)	

Care of the product

The probe contains no user-serviceable parts. Repair, servicing and calibration require specialized test equipment and must only be performed by Pico Technology or an approved service provider. There may be a charge for these services unless covered by the Pico two-year warranty.



WARNING

To prevent injury or death, do not use the product if it appears to be damaged in any way, and stop use immediately if you are concerned by any abnormal behavior.



CAUTION

To prevent damage when cleaning the exterior of the probe, use a soft cloth moistened with either distilled water or isopropyl alcohol. Before use allow the probe to dry completely. Do not allow liquids to enter the probe casings and ensure that the probe is completely dry before use.

To prevent measurement error or damage to the probe or other connected equipment, do not attempt to measure voltages outside the specified full-scale measurement range or overvoltage protection range below. In a combination the lower rating / measurement category always applies to both probe and accessories connected to it.

Take care to avoid mechanical stress or tight bends on the coaxial cable connecting the probe head to its interface box or BNC connector. Mishandling could degrade performance and measurement accuracy. Avoid mechanical shock to the probe in general to guarantee accurate performance and protection.

To avoid injury, handle with care especially when fitted with the extra thin and sharp spring contact tip.

About the probe

The TA133 and TA150 passive probes set new standards in high-performance probing.

The compact design with only 2.5 mm housing diameter at the probe tip is ideal for measurements of SMT components. It provides a much better visibility of the device under test than conventional 5 mm probe housing designs.

A valuable Pico Technology feature is the exchangeable probe tip. The gold-plated spring contact and the rigid tip are only 0.5 mm in diameter. Tip replacement is easy and gives the engineer a convenient choice.

The shortest possible ground connection is recommended, particularly for HF measurements on ICs. Due to long ground leads, most conventional adaptors bring additional inductance and resonances into the measurement which result in false or inaccurate readings. The innovative IC contacting system for the TA133 and TA150 utilizes 5 different IC adapters from 0.5 to 1.27 mm pitch. In combination with the ground blade and IC ground copper pad, it is the ideal solution for short-circuit-safe, reproducible, and reliable measurements.

Over a dozen accessories for the TA133 and TA150 enable a variety of configurations to solve most adaptation needs. For further information on available accessories please refer to the "Probe accessories" section later in this User's Guide or contact our service department.

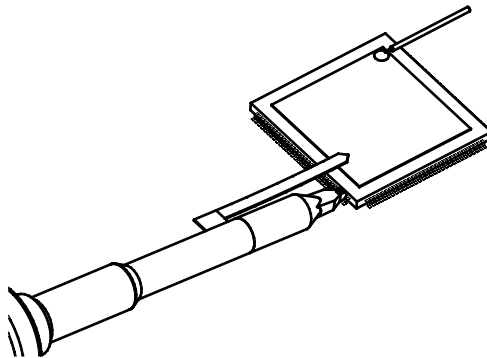

IC contact system with IC adapter, ground blade and IC ground copper pad.

Specifications

Specifications marked "typical" are published as general information for the user. The environmental conditions should not exceed the probe's specified limits.

Specifications are subject to change without notice.

Electrical specifications

	TA133	TA150	
Attenuation ratio ⁽¹⁾	10:1		(±2% at DC)
Voltage coefficient	0.0025 %/V		(typical)
Probe bandwidth	500 MHz	350 MHz	(-3 dB)
Probe risetime	700 ps	1 ns	(10%-90%, typical)

(1) Connected to oscilloscope with an input impedance of $1\text{ M}\Omega \pm 1\%$.

Electrical characteristics

Input resistance (system)	10 M Ω	± 1 %
Input capacitance (system)	9.5 pF	(typical)
Compensation range	10 pF to 25 pF	(typical)
Input coupling of the measuring instrument	1 M Ω AC / DC	

Input impedance

**CAUTION**

To avoid overloading the circuit under test, note that the input impedance of the probe decreases as the frequency of the applied signal increases.

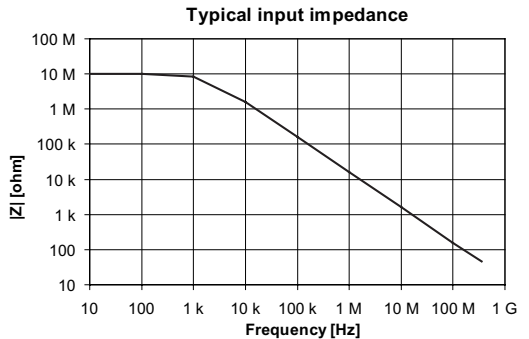

Mechanical characteristics

Weight (probe only)	48 g
Cable length	1.3 m
Probe tip diameter	2.5 mm

Adjustment procedure

The probe can be adjusted for low frequency (LF) compensation.

LF compensation is necessary whenever the probe is connected to a new oscilloscope input channel. LF compensation matches the probe's series capacitance to the oscilloscope's input capacitance. This matching assures good amplitude accuracy from DC to upper bandwidth limit frequencies. A poorly compensated probe influences the overall system performance (probe + scope) and introduces measurement errors resulting in inaccurate readings and distorted waveforms.

LF compensation is performed by connecting the probe to a suitable signal source such as:

- the CAL output on the oscilloscope front panel
- a good-quality 500 Hz square wave from the AWG output of a PicoScope
- a square wave output from an oscilloscope calibrator

and adjusting the LF compensation trimmer to obtain optimal square wave response. For examples see figures below.

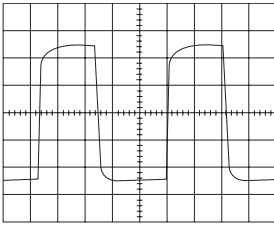

undercompensated

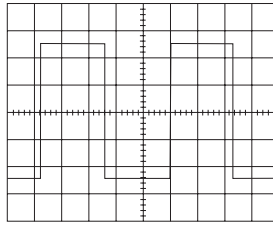

optimal

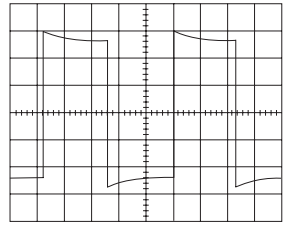

overcompensated

LF compensation trimmer

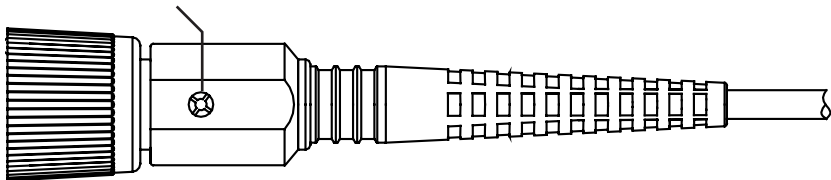

Probe accessories

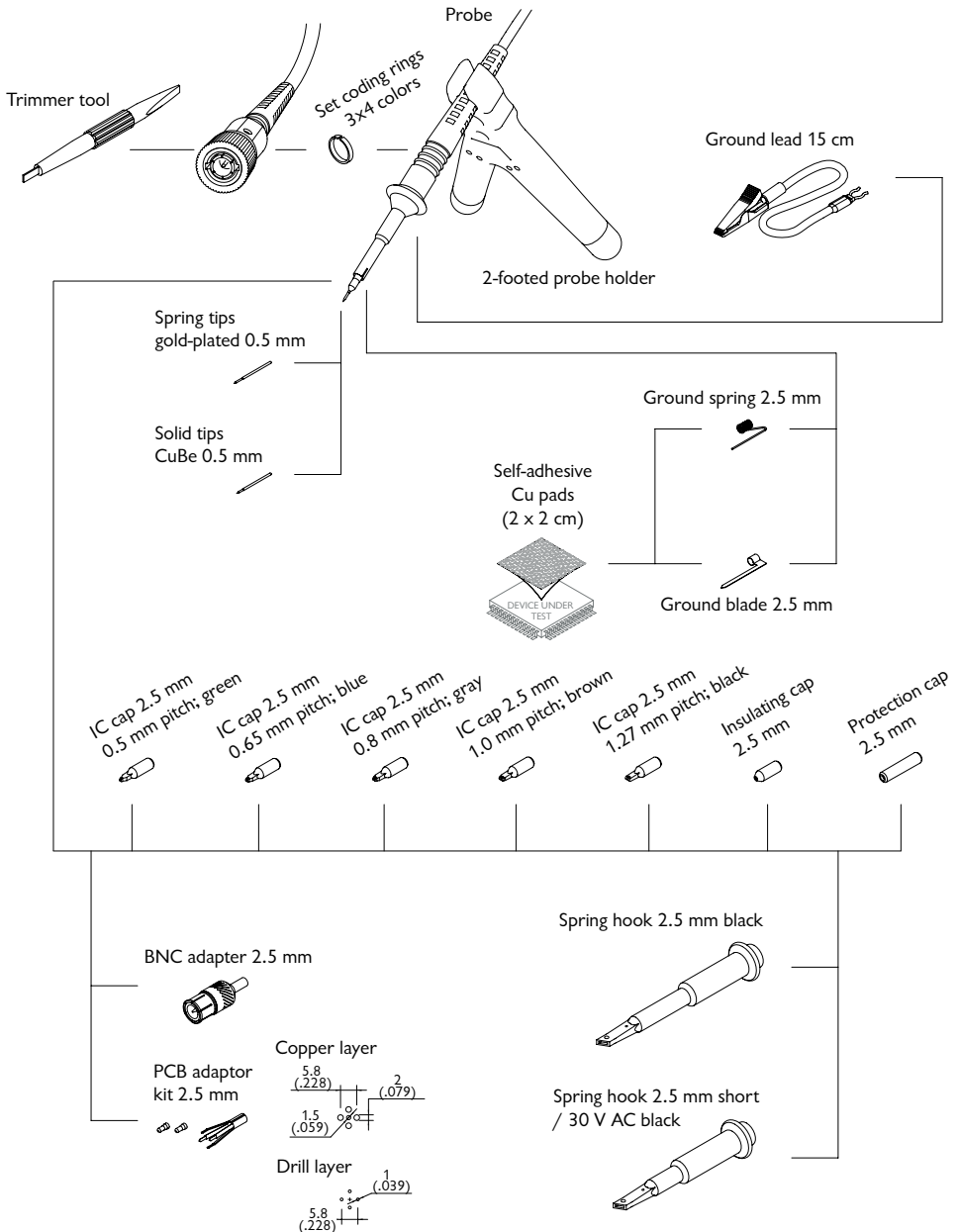

For further information on available accessories please refer to the accessory kits listed on page 10.

Probe accessories

You can buy a range of kits containing accessories and spare parts for the TA133 and TA150 probes. Contents of the standard product packs and optional kits are listed below.

Item	TA150 (4-pack) supplied with scope	TA133 (4-pack) supplied with scope	TA066 basic accessory kit	TA067 standard accessory kit	TA065 advanced accessory kit	TA152 BNC adapter kit	TA068 solid probe tips	TA064 spring contact tips	TA102 2-footed probe holder	TA150 probe kit	TA133 probe kit
Coding rings (set) 3x4 colors	2	2			1					1	1
Ground blade 2.5 mm					1						1
Ground lead 15 cm*	4	4	1	1	1					1	1
Ground spring 2.5 mm	4	4			1					1	1
IC cap 2.5 0.5 mm pitch; green					1						1
IC cap 2.5 0.65 mm pitch; blue					1						1
IC cap 2.5 0.8 mm pitch; grey					1						1
IC cap 2.5 1.0 mm pitch; brown					1						1
IC cap 2.5 1.27 mm pitch; black					1						1
Insulating cap 2.5 mm	4	4		1	1					1	1
PCB adapter kit 2.5 mm					1						1
Self-adhesive Cu pad 2 x 2 cm					2						2
Solid tip CuBe 0.5 mm	4	4	1	1	1		5			1	1
Spring tip gold plated 0.5 mm	4	4	1	1	1			5		1	1
Spring hook, short, 2.5 mm / 30 V AC			1	1	1						
Spring hook 2.5 mm	4	4								1	1
Trimmer tool	2	2		1	1					1	1
BNC adapter 2.5 mm†				1	1	1					
2-footed probe holder									1		



* WARNING. To avoid injury and equipment damage, use for ground connections only.



† WARNING. To avoid exposure to dangerous voltages, do not use with signals above 42 V peak.



WARNING. All accessories are safety-tested. Replace only with Pico Technology accessories.

Changing the probe tip

To change the probe tip use pliers to grip and pull it carefully straight out of its contact socket, along the axis of the probe. Do not grip the white plastic insulator or the housing with pliers, because the tip could be squeezed and made impossible to remove and the probe could be damaged.

After the probe tip is removed, the new tip can be inserted with pliers into the contact socket along the axis of the probe. In order to insert the probe tip completely into the housing, press the probe tip carefully against a hard surface.

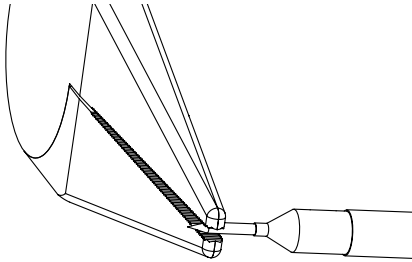

Use pliers to grip and pull the probe tip carefully out of its contact socket.

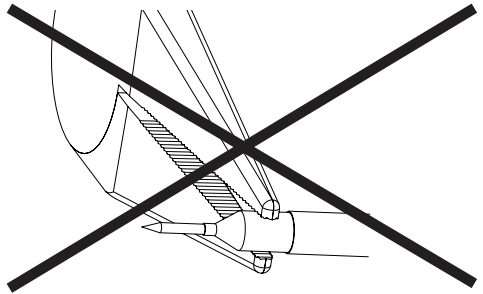

Do not grip the white plastic insulator or the probe housing with pliers.



UK headquarters:

Pico Technology
James House
Marlborough Road
Colmworth Business Park
Eaton Socon
St. Neots
PE19 8YP
United Kingdom

Tel: +44 (0)1480 396395
Fax: +44 (0)1480 396296

sales@picotech.com
support@picotech.com

www.picotech.com

11 Jun 2015

US headquarters:

Pico Technology North America, Inc.
320 N Glenwood Blvd.
Tyler
TX 75702
United States

Tel: +1 800 591 2796 (toll free)
Fax: +1 620 272 0981

DO251-I