

N5991 USB4

Receiver Compliance Test Automation Software

N5991U40A

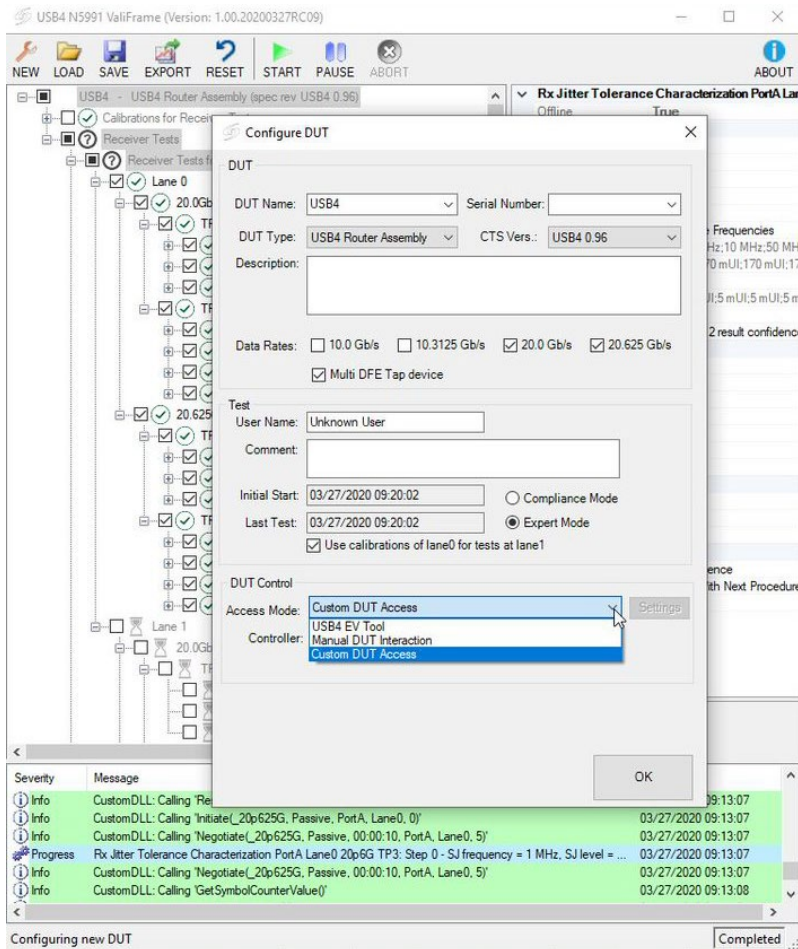

Table of Contents

At a Glance	3
Turn Your Instruments into a Solution	3
Fast and Reliable Testing	3
Standardize Your Tests	4
Test Selection and Test Results.....	4
N5991U40A USB4 Receiver Tests.....	5
Calibrations	5
Receiver Tests	6
Beyond Compliance.....	8
Add-Ons.....	9
USB4 Custom DUT Access.....	9
Receiver Test Proprietary Eye Monitor Support Add-on.....	9
Receiver Test Proprietary Script Automation Support	9
Ordering Information	10
License Types	10
Instrument Requirements	11
System Requirements	11
Software.....	11
Requirements	11
Recommendation.....	11
Hardware.....	11
Requirements	11
Recommendations	11
Remote Power Cycling.....	11
Remote Programming	11
Related Products	12

At a Glance

High-speed digital standards are quickly evolving to keep pace with emerging technologies such as 5G, Internet of Things (IoT), artificial intelligence (AI), virtual reality (VR), and autonomous vehicles.

Each generational change introduces new test challenges for your digital designs. You need to test your high-speed digital designs across all product development stages — from design and simulation, analysis, debug, and compliance test. The N5991 software solution anticipates test challenges, optimizes performance, and accelerates time-to-market of your high-speed computing interfaces, data center connections, and consumer electronics.

- Supported standards include USB, PCI Express, DP, CCIX, SAS and HDMI. Other standards will be continuously added with the requirements for higher data speed testing
- Guided setup with automated fast stress signal calibrations and compliance measurement functions
- Modern look and feel with enhanced functionalities
- System modularity allows the user to enable only required functionalities
- HTML / Excel test reports
- Link Training Suite products with specific standard that feature debugging of DUTs
- Node-locked or transportable licenses, which include 12 months of service, support and updates
- Characterization mode for in-depth testing
- Support for real-time parameter changes of amplitude levels, jitter components...
- Optional user programming for legacy code integration (such as LabVIEW, VEE, C++) and custom test procedures

Turn your instruments into a solution

An efficient test strategy is a proven competitive advantage. The Keysight N5991 test automation software platform is the successor to the well-known industry standard N5990A test automation software platform. While it follows the same concept of combining the performance of your instruments with the convenience of your PC, the latest N5991 test automation software platform provides unprecedented test integration, high-throughput, and ease-of-use for a wide range of stimulus and response systems. This approach provides a level of control that transforms a collection of instruments into a universal, user-friendly and highly productive test solution.

Fast and reliable testing

The comprehensive N5991 software platform increases test speed, reduces test costs, and ensures greater thoroughness than manual electrical testing. If, for example, the USB standard is tested using the N5991 software, you can test a wide range of products – devices, hosts or retimers – whether they are production-ready prototypes, development boards, or chipsets.

Standardize your tests

The N5991 receiver-test options provide dedicated receiver compliance tests for popular and emerging digital buses. You can choose compliance mode for fast certification testing, or characterization mode for in-depth analysis. The Receiver Test Automation Platform’s compliance testing capabilities have been repeatedly proven at interoperability workshops or “plug-fests”.

The N5991 platform has been built upon the success of previous generations to deliver significant gains in productivity. Like its predecessor (the N5990A software), the interface for the new system has been designed using a common framework, which makes it easy to test multiple buses, such as USB, PCI Express, CCIX, SAS and more. It delivers additional gains by using HTML or Excel formats for reporting results. The N5991 software architecture is based on C# code and Microsoft .NET, which, in conjunction with on-the-fly amplitude and jitter control supported by many Keysight instruments, ensures fast interaction, calibration, and test execution for the highest possible throughput.

Test selection and test results

The test automation software platform lets you select tests from an intuitive tree structure with multiple levels of detail. Select the tests you want to run, as well as the number of repetitions. Test results are provided in HTML or Microsoft Excel format. Measuring results are reported in parameter tables and graphically in curves (see Figure 1).

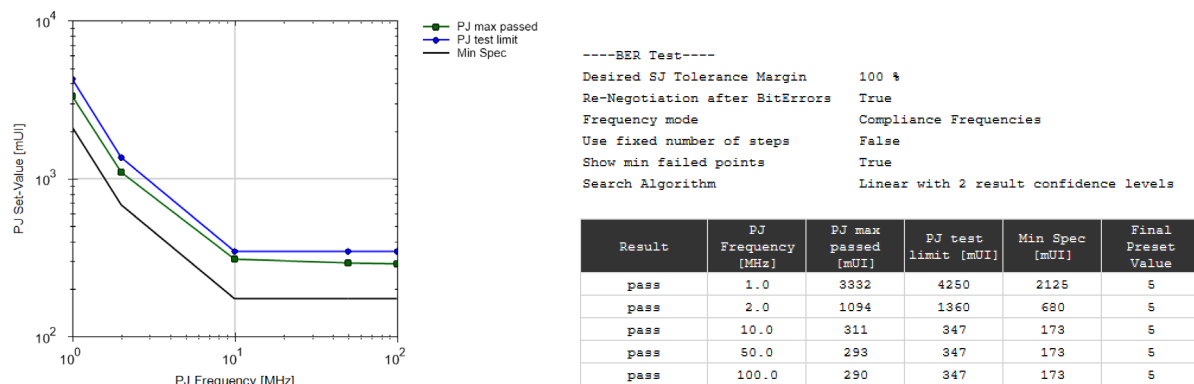

Figure 1: USB4 20 Gb/s Jitter Tolerance Measurement – Graphical and Tabular Result

N5991U40A USB4 Receiver Tests

USB4 is the next generation of the broadly adopted USB protocol. Doubling the PHY bitrate of its predecessor USB 3.2 from 10 Gb/s to 20 Gb/s, USB4 increases the throughput of the USB Type-C® interface, supporting data transfers of up to 40 Gb/s. In addition, USB4 supports optional compatibility with TBT3, operating at PHY bitrates of 10.3125 Gb/s and 20.625 Gb/s.

As PHY rates increase and products tend to be more compact and portable, the validation of new designs becomes more challenging than ever before. N5991U40A is designed to eliminate the complexity of validating USB4 receivers, maximizing your productivity and helping you bring your products to the market before the competition. N5991U40A implements all procedures to calibrate the stress signal and to test receivers as described in the *USB4 Router Assembly Electrical Compliance Test Specification* or *USB4 CTS*, published by the USB Implementers Forum (USB-IF).

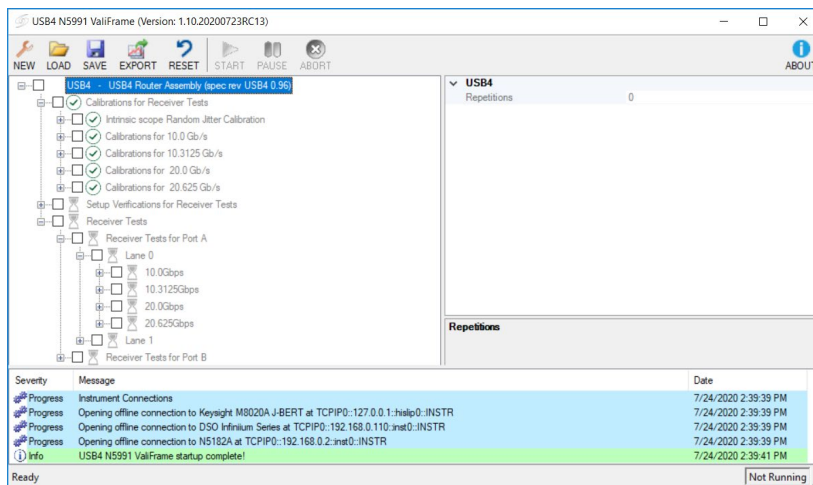

Figure 2: N5991U40A test tree overview

Calibrations

Stress signal calibration for USB4 testing is cumbersome, as it requires an extremely fine adjustment to obtain the required stress level by tuning the signal amplitude, the channel equalization and the channel insertion loss with 1 dB tolerance. Besides, various impairments like random jitter, sinusoidal jitter or common-mode interference must be characterized in advance before adding them to the test signal. The slightest deviation from the process can lead to invalid stress conditions, and thus invalid test results.

N5991U40A offers an intuitive user interface and ensures accuracy and repeatability with minimal user interaction, reducing the duration of the calibration process from weeks to hours. It includes precise guidance with high-detailed connection diagrams which minimize the sources of error.



Figure 3: Stress signal calibration at TP3' or Case 1 with pattern generator and common-mode interference source

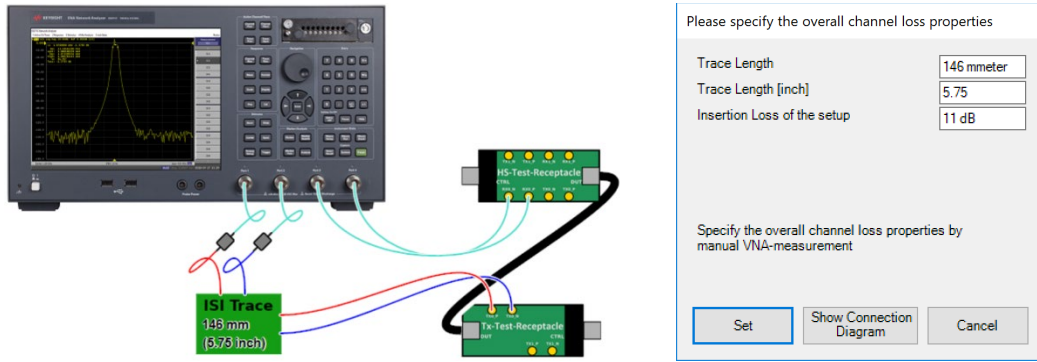

Figure 4: Guided insertion loss calibration at TP3 or Case 2

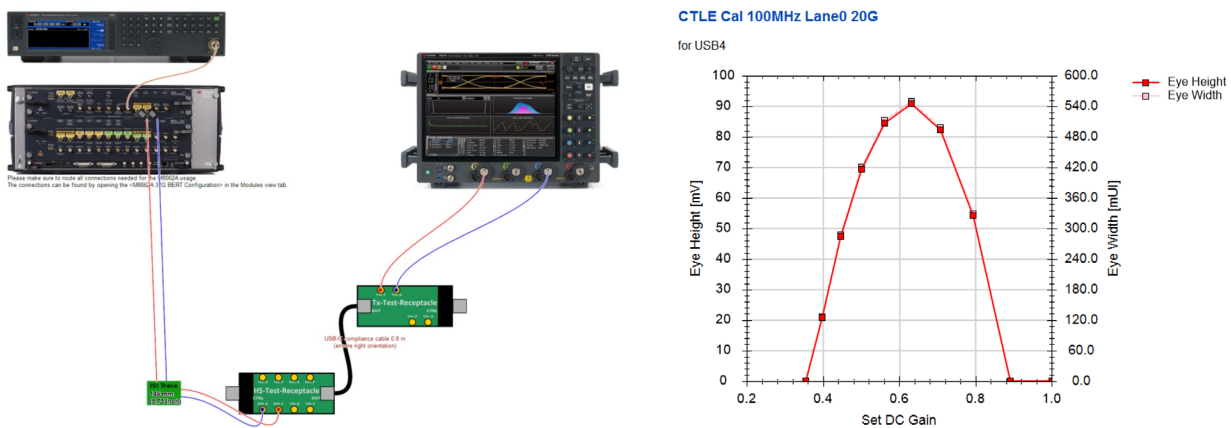

Figure 5: Receiver CTLE calibration at TP3 or Case 2

Receiver Tests

USB4 receiver testing does not require an error detector. Instead, USB4 products are required to implement an error counter that is accessed during the test. This is done by communicating with the USB4 DUT over the sideband channel with an external test controller.

During the test, the stress signal from the pattern generator is injected on the lane under test, and the test controller is used to generate an aggressor signal that is injected on the neighbor lane. N5991U40A gives very clear guidance on how to connect the different pieces of the setup.

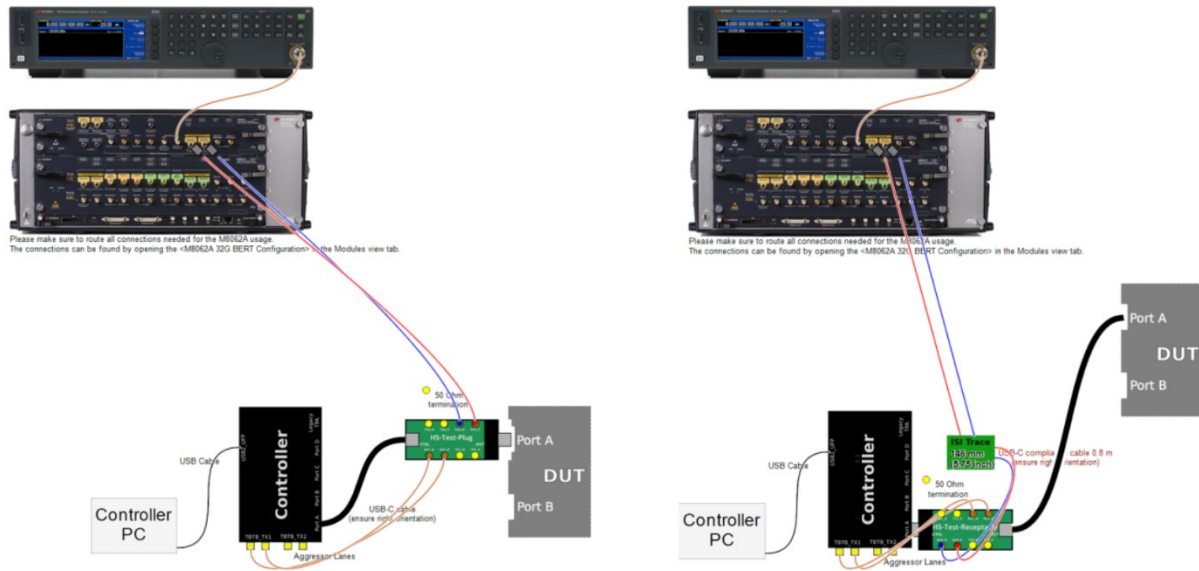

Figure 6: Receiver BER Test setup on Lane 0 at TP3' or Case 1 (left) and at TP3 or Case 2 (right)

```

----Impairments----
Total channel loss      18.5 dB
Add Generator ISI      False
----Generator----
Pattern                PRBS 31
SSC                    True
SSC Frequency          32 kHz
SSC Amplitude upwards  300 ppm
SSC Amplitude downwards -5300 ppm
Data Output Polarity   INverted
----Spec Values----
Total Jitter           380 mUI
Eye Height             700 mV
AC CM Amplitude        100 mV
AC CM Frequency        400 MHz
----BER Test----
Test Duration 1st Run  200 s
Test Duration 2nd Run  350 s
----Instruments----
Data Generator         Keysight M8020A J-BERT, Keysight M8020A J-BERT, SN: Unknown
Data Generator FW      Unknown
AcCm Source           N5171B EXG
  
```

Result	DJ Frequency [MHz]	AC CM Set Amplitude [mV]	PRBS Set Amplitude [mV]	RJ Set Value (RMS) [mUI]	DJ Set Value [mUI]	passed negotiations	Errors 1st Run	Received Symbols 1st Run	Errors 2nd Run	Received Symbols 2nd Run	Final Preset Value
pass	1	240	878	13.60	2125	4	0	125000000000	-	-	5
pass	2	240	878	13.60	680	4	0	125000000000	-	-	5
pass	10	240	878	13.60	173	4	0	125000000000	-	-	5
pass	50	240	878	13.60	173	4	0	125000000000	-	-	5
pass	100	240	878	6.40	255	4	0	125000000000	-	-	5

Figure 7: Receiver BER Test report

N5991U40A covers all high-speed receiver tests defined by the USB4 CTS:

Test Item	10 Gb/s	10.3125 Gb/s	20 Gb/s	20.625 Gb/s
Receiver BER Test	●	●	●	●
Receiver Multi Error-Burst Test			●	●
Receiver Signal Frequency Variations Training Test	●	●	●	●

Beyond compliance

Earning compliance certification is the first step to bring your product into the market. But it is not the last. Technology experts must make sure that their product will be able to interoperate with a wide range of products from other vendors once it has reached the market. N5991U40A will give you the extra confidence that you need by pushing your product beyond the limits of compliance testing. N5991U40A includes two additional receiver tests besides the compliance test suite under the *Expert Mode* configuration.

The *Jitter Tolerance Characterization Test*, also known as *Jitter Margin Test*, makes use of the full jitter injection capabilities of the pattern generator to overstress your product beyond the designated amplitudes in *Compliance Jitter Tolerance Test*.

Result	PJ Frequency [MHz]	PJ max passed [mUI]	PJ test limit [mUI]	Min Spec [mUI]	Final Preset Value
pass	1.0	3332	4250	2125	5
pass	2.0	1094	1360	680	5
pass	10.0	311	347	173	5
pass	50.0	293	347	173	5
pass	100.0	290	347	173	5

Result	PJ Frequency [MHz]	AC CM Set Amplitude [mV]	PRBS Set Amplitude [mV]	RJ Set Value (RMS) [mUI]	PJ Set Value [mUI]	passed negotiations	Errors 1st Run	Received Symbols 1st Run	Errors 2nd Run	Received Symbols 2nd Run	Final Preset Value
pass	1	240	878	13.60	2125	4	0	125000000000	-	-	5
pass	2	240	878	13.60	680	4	0	125000000000	-	-	5
pass	10	240	878	13.60	173	4	0	125000000000	-	-	5
pass	50	240	878	13.60	173	4	0	125000000000	-	-	5
pass	100	240	878	6.40	255	4	0	125000000000	-	-	5

Figure 8: Test results comparison: *Jitter Tolerance Characterization Test* (top) and *Compliance Jitter Tolerance Test* (bottom)

The Sensitivity Test will challenge your product's receiver by injecting a test signal decreasing the differential amplitude, allowing you to identify how well your product performs in worst-than compliance conditions.

Result	Eye Height	PRBS Set Amplitude	Test Time	Errors	Received Symbols	Preset Value
pass	700 mV	877 mV	200 s	0	125000000000	5
pass	675 mV	849 mV	200 s	0	125000000000	5
pass	650 mV	821 mV	200 s	0	125000000000	5
pass	625 mV	793 mV	200 s	0	125000000000	5
pass	600 mV	765 mV	200 s	0	125000000000	5
pass	575 mV	737 mV	200 s	0	125000000000	5
pass	550 mV	708 mV	200 s	0	125000000000	5
*** FAIL ***	525 mV	680 mV	200 s	3	125000000000	5

Figure 9: *Sensitivity Test* results

Add-Ons

USB4 custom DUT access

The USB4 CTS requires the use of the USB4 Electrical Test Tool (USB4 ETT) with a test controller to communicate with the DUT during testing to perform operations like resetting the DUT, negotiating the transmitter FFE preset or reading the error counter.

With the USB4 Custom DUT Access Add-On, you can replace these third-party tools with your own, taking full control of the test environment. All you need to do is to implement an API (Application Programming Interface) that N5991U40A will call during tests. This feature will allow you to test your product at early development stages before even having USB PD control or fully-functional USB4 sideband channel communication.

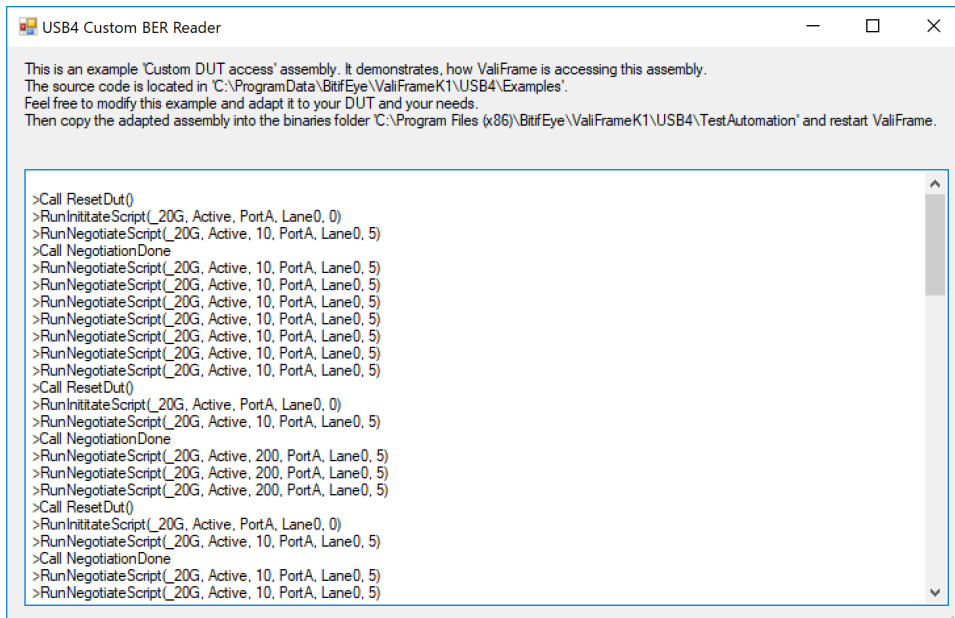

Figure 10: Custom DUT access example

N5991U40A contains a source code example and gives clear instructions on how to implement your custom control logic and integrate it into the test automation process.

Receiver test proprietary eye monitor support add-on

For special chip families, a proprietary test tool called *Eye Monitor* can provide valuable insight during receiver testing. Use this add-on to include this tool as part of the test flow.

Please contact Keysight Technologies if you would like more information about this feature.

Receiver test proprietary script automation support

Some chip families support proprietary tools that can be used in conjunction with the USB4 test controller, replacing the USB4 ETT to enable fully automated receiver testing. Use this add-on to integrate such proprietary tools with the test flow.

Please contact Keysight Technologies if you would like more information about this feature.

Ordering Information

N5991U40A USB4 Receiver Test

N5991U40A-1FP	USB4 Receiver Tests, Perpetual node-locked license
N5991U40A-1TP	USB4 Receiver Tests, Perpetual transportable single license
N5991U40A-SFM	USB4 Receiver Tests, SW maintenance, 12 Months, Node-locked License
N5991U40A-STM	USB4 Receiver Tests, SW maintenance, 12 Months, Transportable License

N5991U40A USB4 Receiver Test Add-ons

N5991U4DY-ADD	USB4 Custom DUT Access Add-on
N5991U4EY-ADD	USB4 Receiver Test Proprietary Eye Monitor Support Add-on
N5991U4SY-ADD	USB4 Receiver Test Proprietary Script Automation Support Add-on

License Types

Node-locked – License can be used on one specified computer.

Transportable – License can be used on one computer at a time but may be transferred to another using the BitifEye License Manager.

Instrument Requirements

The N5991U40A USB4 Receiver Test application supports the Keysight M8020A and M8040A High-Performance BERT platforms. The BERT must be equipped appropriately to cover the required data rates, jitter injection, transmitter and receiver equalization and USB link training capabilities.

The *USB4 Electrical Compliance Test Specification* defines a bandwidth of 21 GHz for USB4 calibrations at the fastest bitrate. In order to meet this requirement, Keysight recommends a real-time oscilloscope with a bandwidth of at least 25 GHz.

Please contact Keysight Technologies for more details about the supported instrument configurations.

System Requirements

Software

Requirements

- OS: Windows 10 - 64-Bit, English version
- Microsoft .NET Framework version 4.7.1 or higher
- Keysight IO Libraries Suite 18.1 or higher

Recommendation

- Microsoft Office Excel 2016 or higher, English version

Hardware

Requirements

- Connectivity hardware for instrumentation, depending on configuration e.g. USB 3.0, Ethernet

Recommendations

- Multicore processor with 12 logical processors or more
- 16GB RAM or higher

Remote Power Cycling

All N5991 Receiver Test Automation products can control power strips from Koukaam, Allnet and Synaccess to power cycle a device under test remotely.

Remote Programming

The N5991 ValiFrame remote interface allows ValiFrame functionality, such as test setup information, calibration, test procedures and results, to be accessed from external programming environments. The remote interface does not need a special license to be used, it is included in the base product.

Related Products

D9020USBC USB 3.2 Tx Compliance Test Software

D9040USBC USB4 Tx Test Software

M8020A J-BERT High-Performance BERT

M8040A 64 Gbaud High-Performance BERT

N5991 Receiver Compliance Test Automation Platform

N5991U32A USB 3.2 Receiver Compliance Test Software

U7242A USB 3.0 test fixture

Learn more at: www.keysight.com

For more information on Keysight Technologies' products, applications or services, please contact your local Keysight office. The complete list is available at: www.keysight.com/find/contactus

