

PNA and PNA-X Series Microwave Network Analyzers

Table of Contents

Complete Solutions for a Wide Range of Applications	5
Future-proof your microwave component testing	6
Industry's Most Advanced RF Test Solution	7
Reach for unrivaled excellence	7
Multiple measurements with a single instrument	9
Bottom Line Results - PNA-X Case Studies	11
Case study 1	11
Case study 2	13
Case study 3	13
Case study 4	14
Intuitive, Speed-Driven Features	15
Hardware for Exceptional Flexibility	16
Flexible Architecture	17
PNA Series	19
Highest performance	19
PNA Series	20
New DDS Synthesizers Improve PNA Measurement Performance	21
Measuring next generation devices	21
Innovative Applications	23
Powerful measurement setup assistance, Device Measurement eXpert (DMX) (S94601B/S94602B) ..	23
Network Analyzer Test Setup Assistant (S94605B)	25
Innovative Applications	26
Real-time S-parameter and power measurement uncertainty (S93015B)	26
Innovative Applications	29
Simple, fast and accurate pulsed-RF measurements (S93025/026B, Options 021, 022)	29
Innovative Applications	34
Fast and accurate noise figure measurements (S93029B, Option 029/E29 ²)	34
Innovative Applications	39
Fast and accurate noise parameter measurements for unmatched devices (S93027B, S93029B, Option 029) (PNA-X only)	39
Innovative Applications	41
Fast and accurate gain compression versus frequency measurements of amplifiers and converters (S93086B)	41
Innovative Applications	44
Fast two-tone intermodulation distortion (IMD) measurements with simple setup (S93087B)	44
Innovative Applications	49
Accurate characterization of mixers and converters (S93082/083/084B)	49

Innovative Applications	54
Phase noise measurement for component characterization (S930317B/321B).....	54
Sensitivity (supplemental performance data).....	56
Innovative Applications	57
Fast multi-channel spectrum analyzer for component characterization (S93090x/093/094B)	57
Innovative Applications	61
New capability of spectrum analysis application - Noise Power Ratio (NPR) measurements (S93090x/093/094B)	61
Innovative Applications	64
EVM, NPR and ACPR measurements for component characterization modulation distortion (S93070xB)	64
Innovative Applications	69
Internal 6 GHz arbitrary waveform generation application – (S93072B)	69
Innovative Applications	70
VSA wideband IQ data link application – (S93050B/51B/52B).....	70
Innovative Applications	74
Load Pull Capability for Modulation Distortion Measurements (S94570B/71B)	74
Innovative Applications	76
Innovative Applications	77
Control relative magnitude and phase between two sources for active output-load control (S93088B) 77	
Innovative Applications	79
Simplified test of I/Q converters and modulators, and differential mixers (S93089B)	79
Testing differential amplifiers under real operating conditions (S93460B)	80
Innovative Applications	83
One-box solution for high-speed serial interconnect analysis (S93011B).....	83
Innovative Applications	86
Powerful, fast and accurate automatic fixture removal (AFR) (S93007B).....	86
Innovative Applications	89
Extending the PNA-X to millimeter-wave frequencies	89
Millimeter-wave applications with the PNA-X.....	92
New 170 GHz / 220 GHz Broadband Vector Network Analysis.....	96
Enabling Insights into Broadband device performance	96
Solution Architecture	97
Active hot parameters in nonlinear region (S93110B/111B) (PNA-X only)	98
Innovative Applications	100
Nonlinear waveform and X-parameter characterization (S94510/511/514/518/520/521/522B) (PNA-X only).....	100
Innovative Applications	103
Fast and accurate RF subsystem for antenna measurements	103

Extend the power of the PNA family to multiport devices	107
Outstanding performance.....	109
Configuration Information.....	112
Keysight software licensing options provide flexibility and support	119
Choose your term. Choose your type. Keep control of your budget.....	119
KeysightCare Software Support Subscription provides peace of mind amid evolving technologies....	120
Ordering information	121
Additional Information	122

Complete Solutions for a Wide Range of Applications

2 ports	300 kHz to 8.5 GHz	PNA-X
2, 4 ports	900 Hz /10 MHz to 8.5 GHz	
2, 4 ports	900 Hz /10 MHz to 13.5 GHz	
2, 4 ports	900 Hz /10 MHz to 13.5 GHz	
2, 4 ports	300 kHz to 13.5 GHz	
2, 4 ports	300 kHz to 20 GHz	
2, 4 ports	900 Hz/10 MHz to 26.5 GHz	
2, 4 ports	900 Hz/10 MHz to 26.5 GHz	
2, 4 ports	900 Hz /10 MHz to 43.5 GHz	
2, 4 ports	900 Hz /10 MHz to 43.5 GHz	
2 ports	10 MHz to 43.5 GHz	PNA
2, 4 ports	900 Hz/10 MHz to 50 GHz	
2, 4 ports	900 Hz /10 MHz to 50 GHz	
2 ports	10 MHz to 50 GHz	PNA-L
2, 4 ports	900 Hz/10 MHz to 67 GHz	
2, 4 ports	900 Hz/10 MHz to 67 GHz	
2, 4 ports	900 Hz/10 MHz to 1.5 THz ¹	900 Hz/10 MHz to 1.5 THz ¹
2, 4 ports	900 Hz/10 MHz to 1.5 THz ¹	

1. With frequency extenders



In addition to being very capable standalone network analyzers, PNA and PNA-L instruments often form the core of more advanced measurement systems to serve a variety of microwave measurement applications.

Future-proof your microwave component testing

All members of the PNA family share a common software platform that makes it easy to choose just the right level of performance to match your budget and measurement needs. This commonality guarantees measurement consistency and repeatability and a common remote-programming interface across multiple instruments in R&D and manufacturing. All of the powerful PNA software applications can be added later to meet future test requirements.

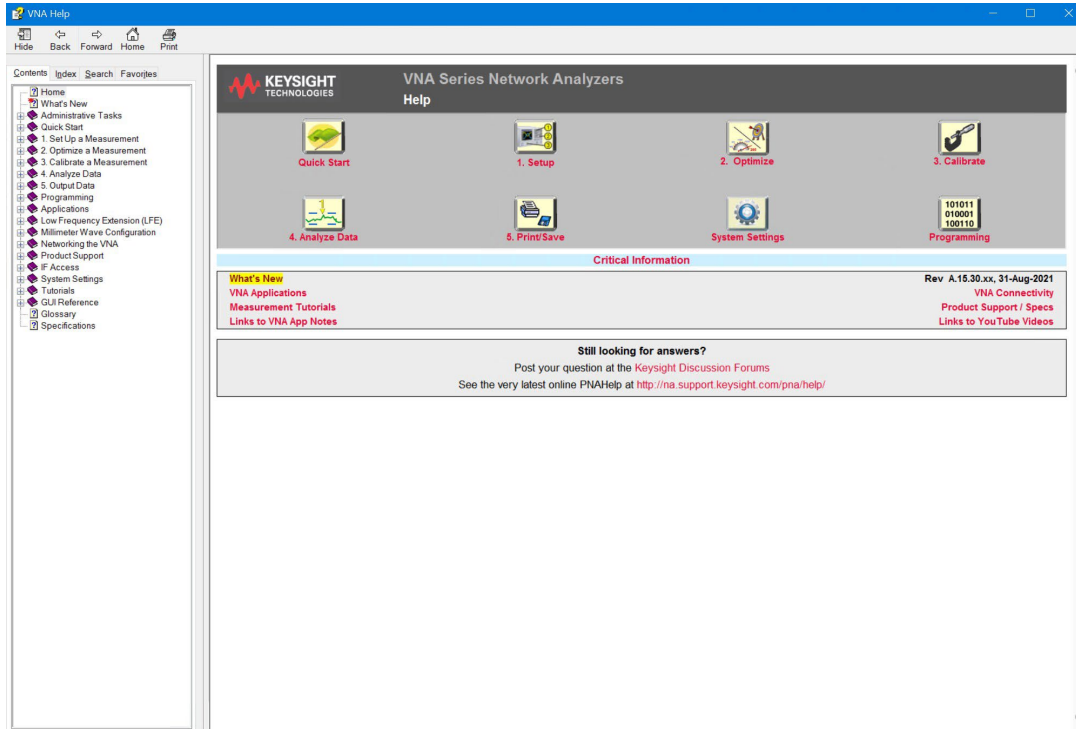

The PNA's built-in help system provides a complete user's guide, including measurement tutorials and programming documentation.

Industry's Most Advanced RF Test Solution

Reach for unrivaled excellence

Choose the leader in network analysis

The PNA-X Series of microwave network analyzers are the culmination of Keysight Technologies, Inc. 40-year legacy of technical leadership and innovation in radio frequency (RF) network analysis. More than just a vector network analyzer, the PNA-X is the world's most integrated and flexible microwave test engine for measuring active devices like amplifiers, mixers, and frequency converters.

The combination of two internal signal sources, a signal combiner, S-parameter and noise receivers, pulse modulators and generators, and a flexible set of switches and RF access points provide a powerful hardware core for a broad range of linear and nonlinear measurements, all with a single set of connections to your device-under-test (DUT).

When you're characterizing active devices, the right mix of speed and performance gives you an edge. In R&D, the PNA family provides a level of measurement integrity that helps you transform deeper understanding into better designs. On the production line, our PNAs deliver the throughput and repeatability you need to transform great designs into competitive products. Every Keysight VNA is the ultimate expression of our expertise in linear and nonlinear device characterization. Choose a PNA - and reach for unrivaled excellence in your measurements and your designs.



All of the PNA-X's powerful measurement applications can be used for on-wafer devices.

World's widest range of measurement applications

PNA-X applications bring speed, accuracy, and ease-of-use to common RF measurements, in coaxial, fixtured, and on-wafer environments. Applications include:

- S-parameters (CW and pulsed)
- Noise figure
- Gain compression
- Intermodulation and harmonic distortion
- Conversion gain/loss
- True-differential stimulus
- Nonlinear waveform and X-parameter* characterization
- Antenna test

* X-parameters is a trademark and registered trademark of Keysight Technologies in the US, EU, JP, and elsewhere. The X-parameter format and underlying equations are open and documented. For more information, visit; <http://www.keysight.com/find/eesof-x-parameters-info>

Network analysis technology down to the nanoscale

The PNA-X is also compatible with these Keysight measurement solutions:

- **Physical layer test system (PLTS)** software to calibrate, measure, and analyze linear passive interconnects, such as cables, connectors, backplanes, and printed circuit boards.
- Materials test equipment and accessories to help determine how your materials interact with electromagnetic fields, by calculating permittivity and permeability.
- Award-winning scanning microwave microscope to create a powerful and unique combination for topography measurements of calibrated capacitance and dopant densities at nanoscale dimensions.

Multiple measurements with a single instrument



Replace racks and stacks

With its highly integrated and versatile hardware and re-configurable measurement paths, the PNA-X replaces racks and stacks of equipment - with a single instrument. One PNA-X can take the place of the following test gear:

- Network analyzer
- Spectrum analyzer
- Three signal sources
- Noise figure meter/analyzer
- Power meters
- Switch matrix
- Digital voltmeter

Benefits of a PNA-X-based solution

- Simpler test systems for...
 - lower hardware and software costs
 - quicker development time and faster time to manufacturing
 - less downtime and lower maintenance costs
 - smaller size and lower power consumption
- Faster test times for...
 - improved throughput
- Higher accuracy for...
 - better yields and better specifications
- Flexible hardware for...
 - greater adaptability to future test requirements

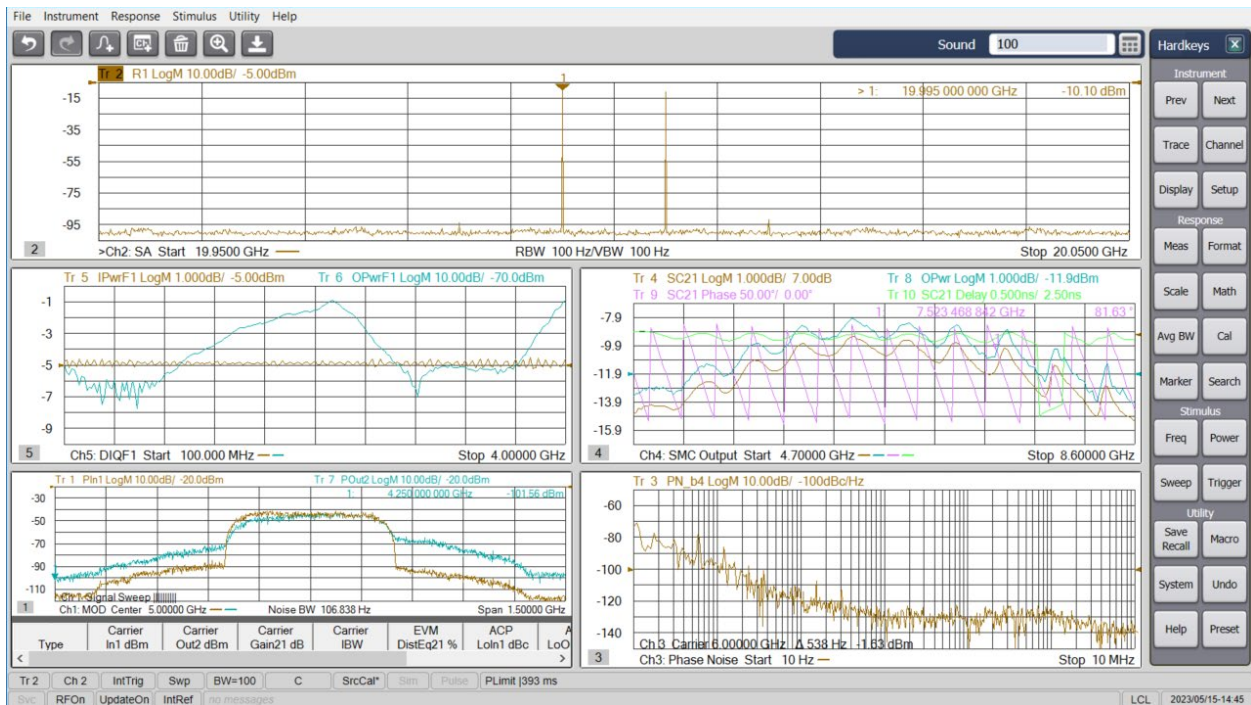
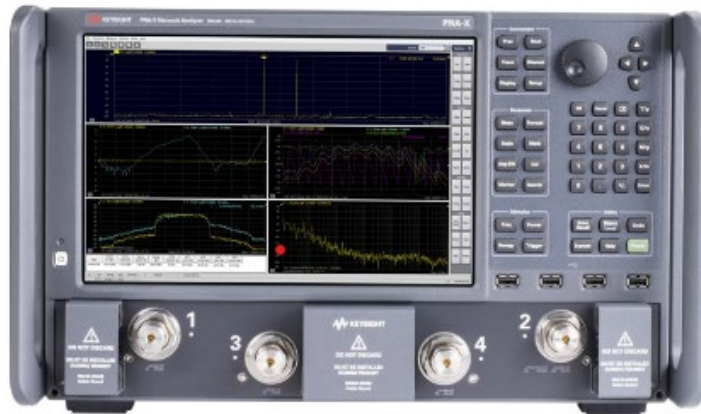

With a single set of connections to an amplifier or frequency converter, the PNA-X can measure CW and pulsed S-parameters, intermodulation distortion, gain and phase compression versus frequency, noise figure, and more.

Bottom Line Results - PNA-X Case Studies

Case study 1

Aerospace/defense component supplier reduces test time by 95%

Challenges

This customer manufactures over 4600 RF components, with typically 1000 devices in the manufacturing process at any given time. Devices included filters, multipliers, amplifiers, and switches, from 10 MHz to 60 GHz. They needed to simplify the test system for one particular multiport device, so they set out to develop an operator independent automated test system (ATS). Key challenges included:

- Complicated and expensive test systems with multiple racks of equipment and miles of test cables
- Multiple cable swaps and recalibrations required with extensive operator intervention and downtime
- Significant retesting of devices and high system downtime

Results

The PNA-X's ability to incorporate more active measurements into a single instrument than any other product on the market provided:

- **Faster test times:** Reduced test times from four hours per temperature to 24 minutes when compared to the prior ATS, resulting in a test-time reduction of 95%
- **Reduced equipment count:** Replaced nine racks of equipment with three, 12- port PNA-X network analyzers
- **Increased operator productivity:** Enabled operators to monitor four test stations simultaneously and eliminated the need for single-operator test stations
- **Reduced re-testing and cable swaps**

We selected Keysight's PNA-X because it eliminated unnecessary cable swaps between measurements, and it makes more active measurements than any other network analyzer out there. We used to make S-parameter, vector-signal, and noise-figure measurements with separate test equipment— and now with the PNA-X, we can perform all of our active measurements in one box.

Test Engineering Manager

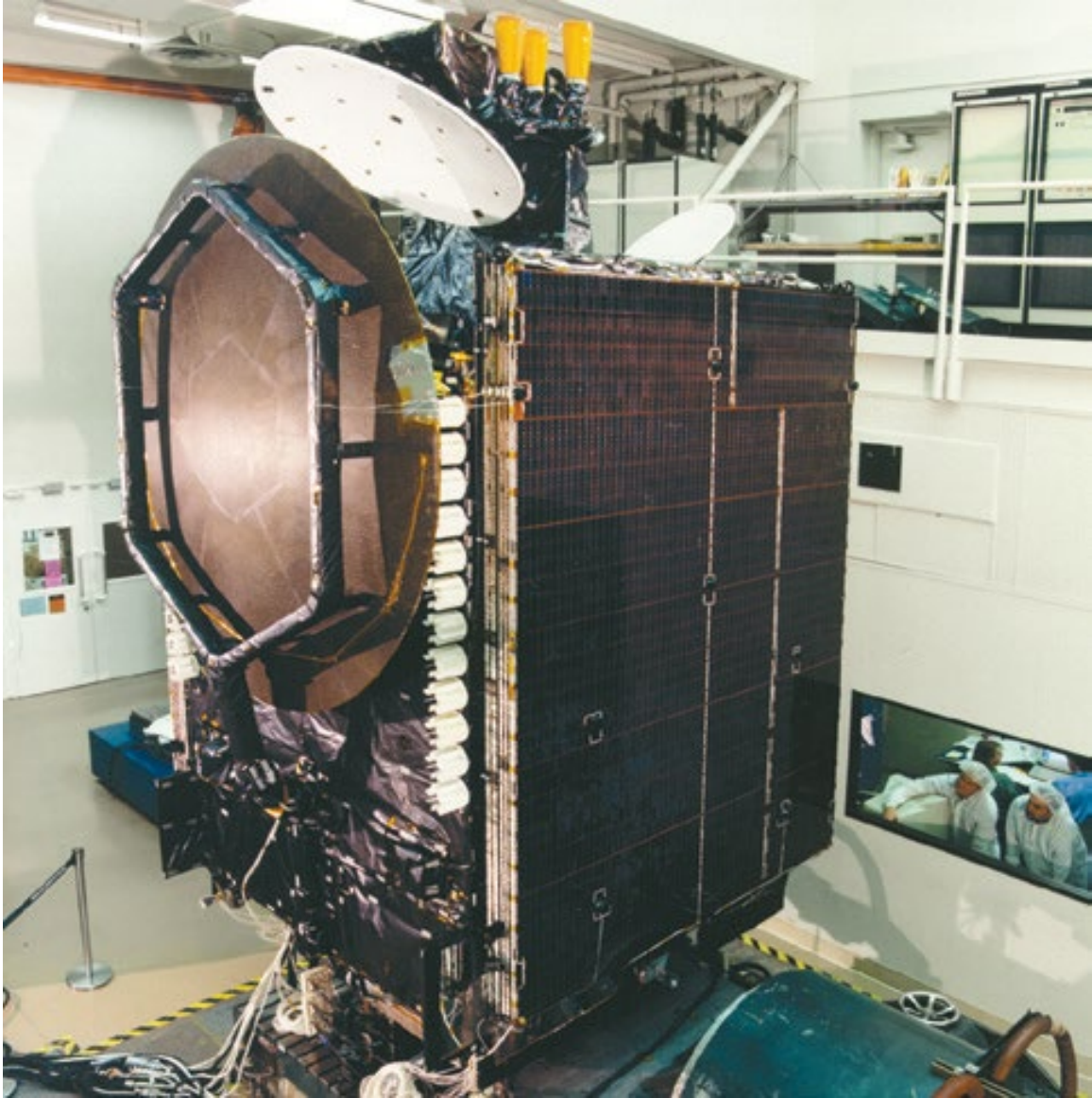

Case study 2

Satellite designer and manufacturer reduces test time from 3 hours to 3 minutes

Challenges

This aerospace company was conducting a specific panel-level test and wanted to modernize its test systems and improve its test productivity and throughput. Its legacy satellite payload test systems utilized a large amount of rack and stack equipment accompanied by a big test overhead. The company was required to exert a great deal of time and effort to program and maintain the test systems.

Results

Initially the aerospace company purchased four PNA-Xs (26.5 and 50 GHz models). They were so impressed with the throughput and test productivity results, that they purchased eight more analyzers. In one test case, the level of improvement exceeded expectations—taking a 20-minute gain-transfer test to just under a minute. Replacing their test system with the PNA-X effectively modernized and simplified their test system which enabled:

- **Faster test times:** Complete test suite cut measurement times from 3 hours to 3 minutes
- **Reduced equipment count:** Replaced a two-rack payload test system with a single four-port PNA-X
- **Smaller test system:** Reduced the amount of equipment space and power consumption

Case study 3

Wireless networking systems manufacturer reduces throughput from 30 to 10 minutes

Challenges

The manufacturer was developing a new broadband wireless network system and needed a faster test system. Its existing test system consisted of 2 sources, a spectrum analyzer, and power meters. Using this system, they estimated their new product would take 30 minutes to test; their speed goal was 15 minutes. In addition to a faster test solution, the company also needed better noise figure and distortion measurements, and it required single-connection measurements on both up and down converters.

Results

Replacing their existing multi-instrument test system with a single four-port 50 GHz PNA-X enabled the company to realize:

- **Faster test times:** Complete test suite cut test throughput from an estimated 30 minutes to under 10 minutes
- **Less downtime and reduced maintenance costs:** Reducing the equipment count reduced the setup time, as well as the headaches associated with multiple equipment faults, and resulted in lowered annual calibration costs
- **Cost savings on equipment:** The cost of a four-port PNA-X was substantially less expensive than the legacy multi-instrument test system.

Case study 4

Global security company speeds test and improves measurement accuracy

Challenges

The company needed to upgrade its legacy test systems, which consisted of large switch matrices with network analyzers. They required technicians to keep connecting and disconnecting the device-under-test (DUT) to multiple instruments to make a range of different measurements. This approach was slow, costly, prone to inaccuracy, and required a good deal of user intervention and additional hardware. The company sought a solution that was easy to set up and use, decreased test time and cost, minimized measurement inaccuracy, and offered a smaller footprint.

Results

The company decided to purchase PNA-Xs rather than simply upgrade to newer, code-compatible, drop-in instruments offered by the provider of its legacy test equipment. This decision was made despite the fact that it meant significant rewrite of legacy software. The company saved time over their existing test solutions and realized:

- **Easy setup and use:** Technicians were able to easily connect to a DUT and measure all different parameters in one pass-without additional hardware
- **Faster and more accurate tests:** Using just one instrument technicians were able to conduct their required tests in significantly less time and improve accuracy
- **Smaller test system:** A single four-port PNA-X reduced their initial capital expense, equipment count, floor space, and power consumption, which resulted in lower overall test costs.

We chose the PNA-X for its unique single-connection, multiple-measurement capability. The PNA-X is also the only solution we found that can make accurate nonlinear measurements by using its extended NVNA software option. This saves us an amazing amount of design time because it means we can quickly and accurately characterize the nonlinear behavior of our devices even at crazy high power levels.

Test Engineering Manager

Intuitive, Speed-Driven Features

Flexible, modern user interface: front panel keys, tabbed soft panel, pulldown menus, customizable toolbar, right-click shortcuts, drag-and-drop operation, and 12.1" touch screen

Up to 15 markers per trace

State-of-the-art calibration capabilities

200 measurement channels and unlimited traces

Context sensitive, built-in help

Undo/Redo cancels or restores previous entries

Configurable test set available on all models

Linear, log, power, CW, phase, and segment sweeps

Equation editor and time-domain analysis

Quick access for ECal and other USB devices

Hardware for Exceptional Flexibility

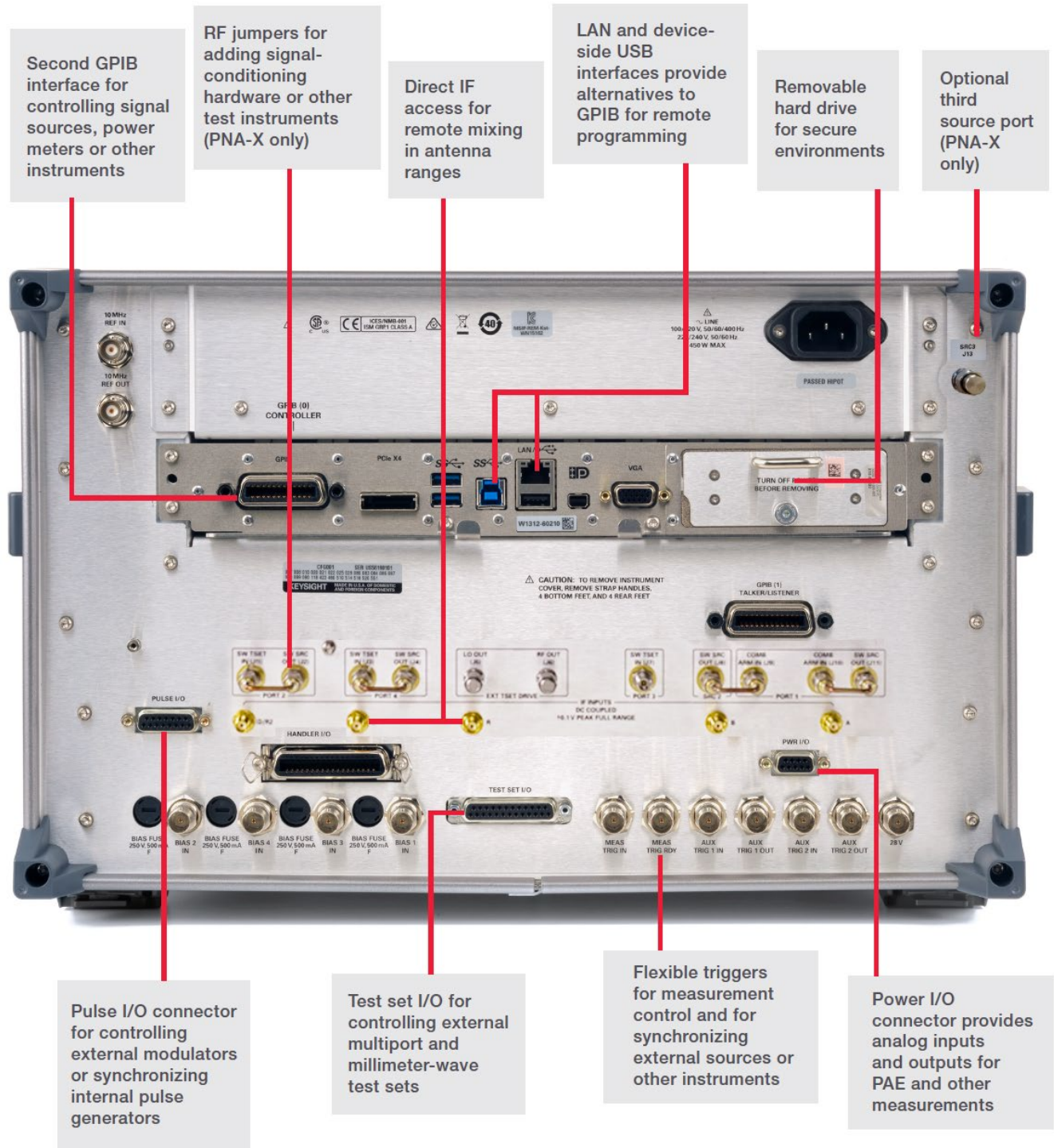

Flexible Architecture

1. Each test port includes test and reference couplers and receivers, source and receiver attenuators, and a bias tee, for maximum accuracy and flexibility.
2. The built-in signal combiner greatly simplifies the setup for intermodulation distortion and X-parameter measurements. (PNA-X only)
3. Internal pulse modulators enable integrated pulsed-RF testing over the full frequency range of the instrument, eliminating expensive and bulky external modulators.
4. Extremely low-phase noise sources with DDS synthesizers enable to characterize active devices without using high-performance analog signal generators. ex. two adjacent tone IMD.
5. Optional third source on 4-port PNA-X can be used as another signal source.(PNA-X only)

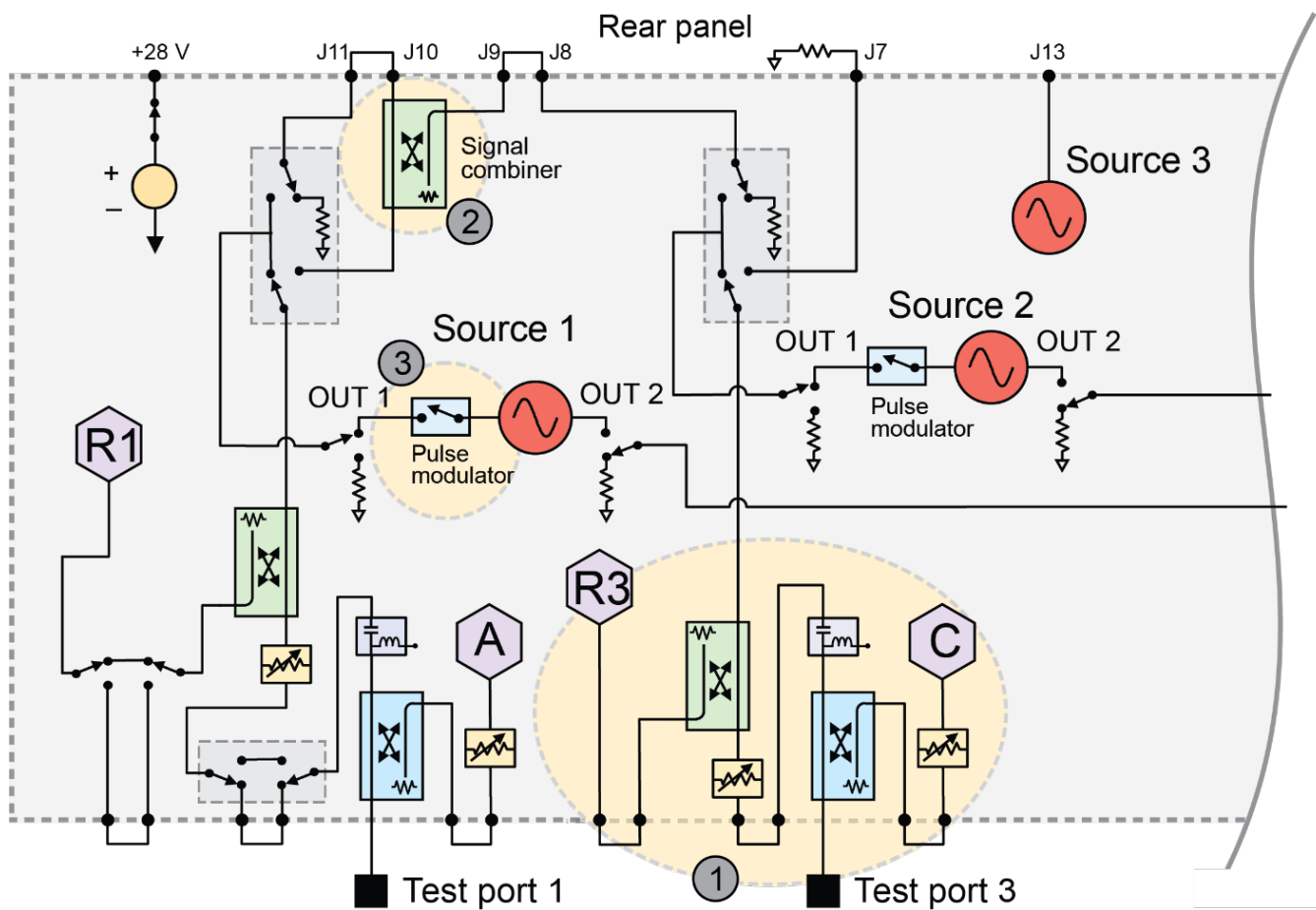

6. Switchable rear-panel jumpers provide the flexibility to add signal-conditioning hardware or route additional test equipment to the DUT without moving test cables. (PNA-X only)
7. Setting up pulse timing for the pulse modulators and internal IF gates is easy using the built-in pulse generators.
8. Internal low-noise receivers, along with advanced calibration and measurement algorithms, provide the industry's most accurate noise figure measurements. (PNA-X only)

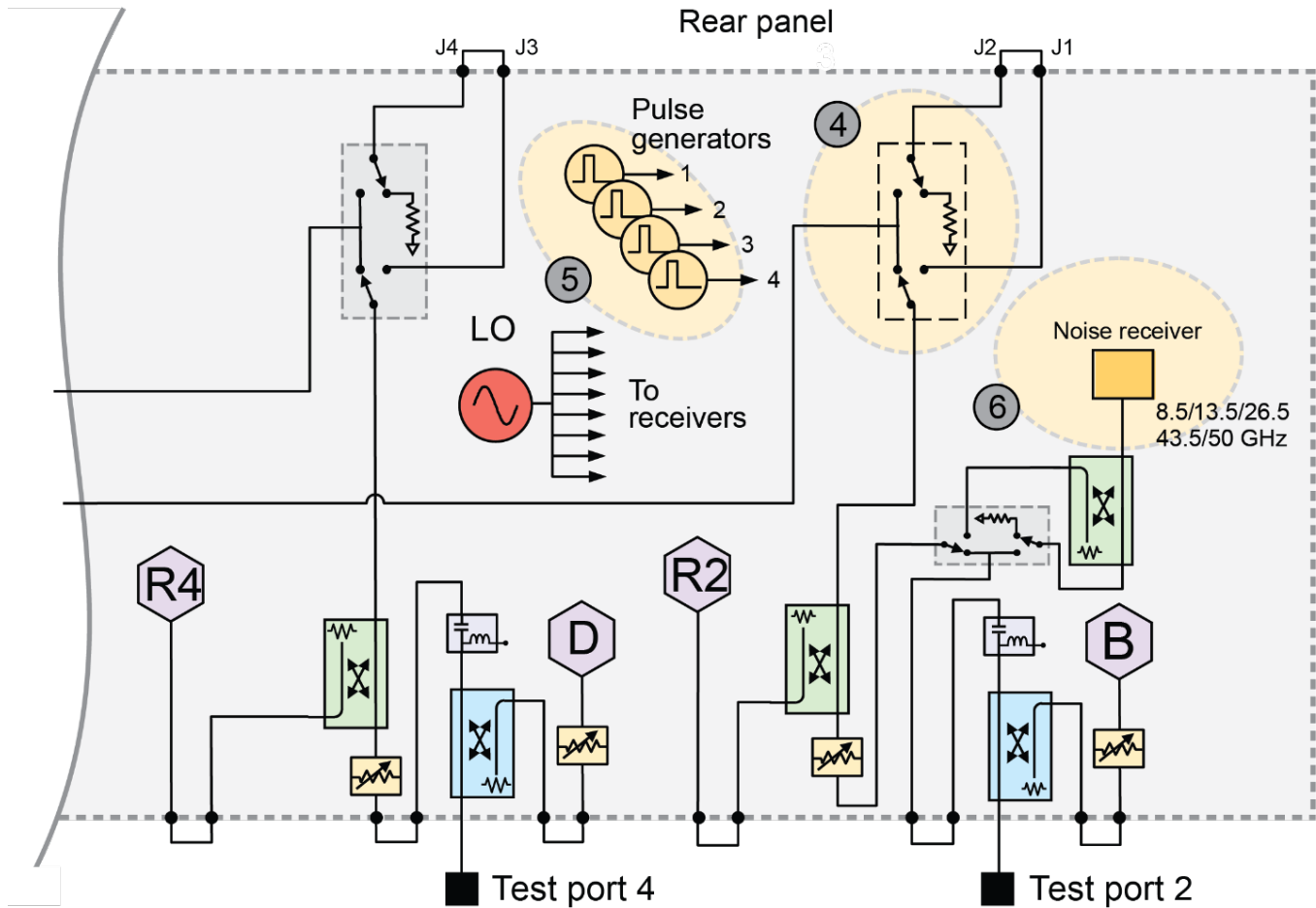

PNA Series

The PNA Series of network analyzers offers industry-leading performance for testing amplifiers, mixers and frequency converters. The PNA Series provides a winning combination of excellent hardware and powerful measurement applications to measure a broad range of devices fast and accurately. All models are available in 2-port single-source and 4-port dual-source versions. Pulsed S-parameters are easy using built-in pulse modulators and pulse generators.



Highest performance

- High source output power of +13 dBm at 1 GHz to +11 dBm at 67 GHz
- High dynamic range: 134 dB at 20 GHz at test port
- Low trace noise: 0.002 dB rms at 1 kHz bandwidth
- Low receiver noise floor
- High receiver compression level
- Fast measurement speed: 3.6 to 23 psec/point
- High stability: < 0.03 dB/°C

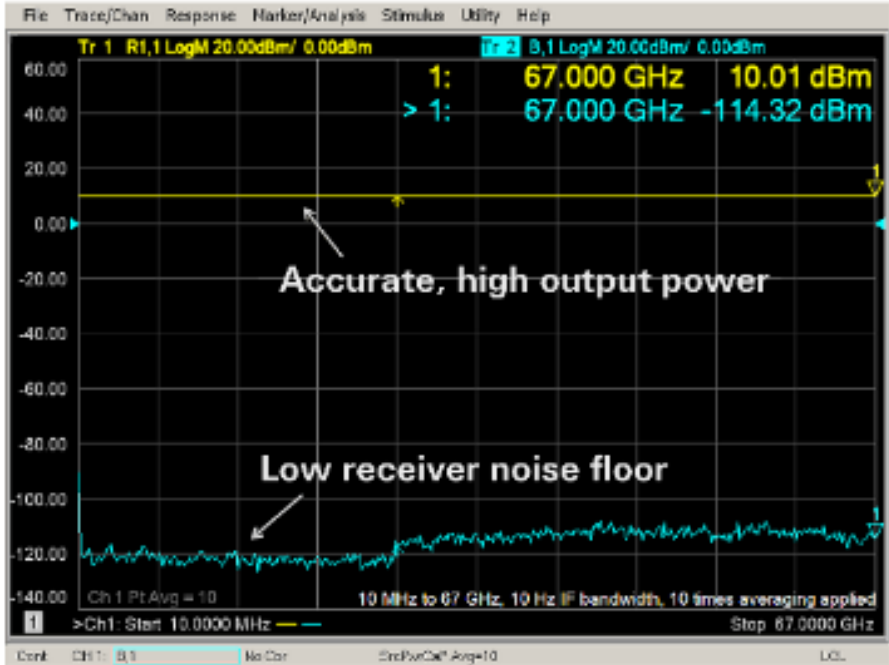

With receiver-leveled output power of +10 dBm and a receiver noise floor of -114 dBm, the PNA typically has 124 dB of dynamic range at 67 GHz, more than any other network analyzer in this frequency range.

PNA Series

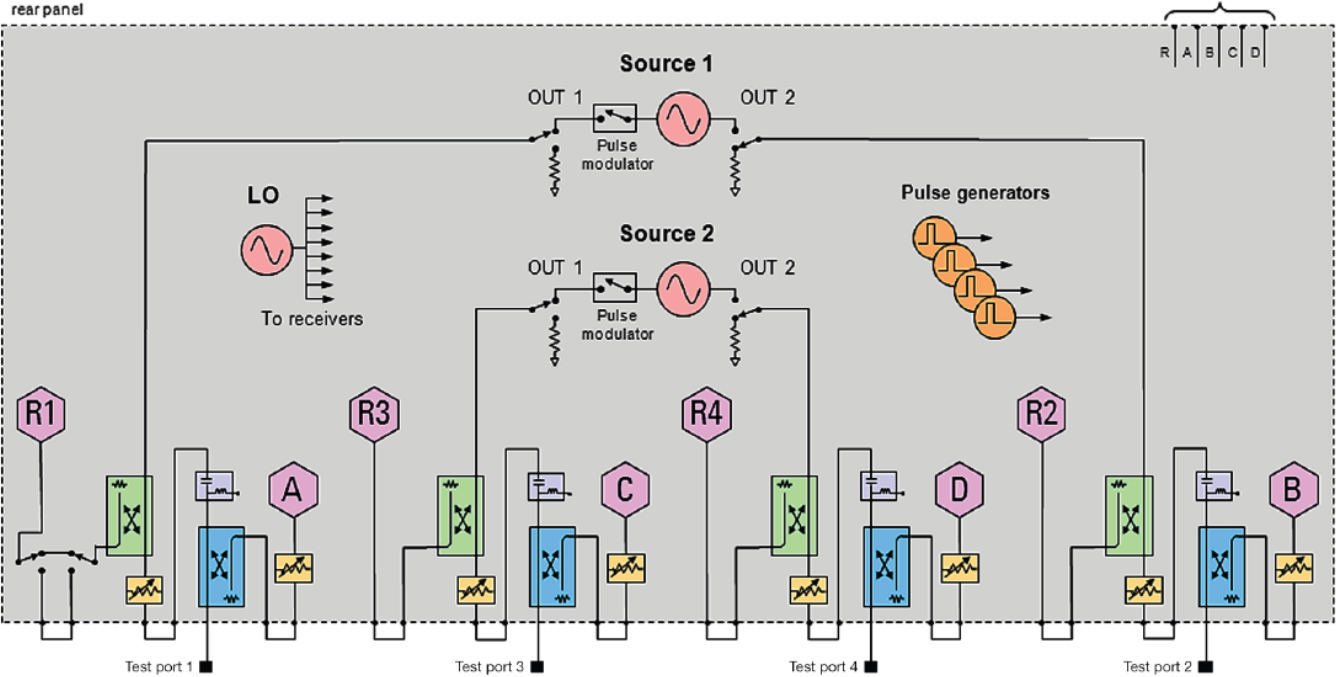

PNA Series block diagram shown with test set Option 419, plus pulse and external-IF options.

Performance	Legacy PNA E836x	New PNA N522x
Port power, 20 GHz	+3 dBm	+13 dBm
System dynamic range, 20 GHz	123 dB	127 dB
Receiver compression, 0.1 dB	-5 dBm	+12 dB
Source power sweep range	27 dB	38 dB
Minimum pulse width, wideband detection	50 us	100 ns

The new PNA Series network analyzers offer significantly better performance compared to legacy models.

New DDS Synthesizers Improve PNA Measurement Performance

Measuring next generation devices

The N522xB PNA and N524xB PNA-X Vector Network Analyzers employed DDS (Direct Digital Synthesizers) as the signal sources in the summer of 2020. DDS sources typically introduce unwanted spurious emissions, but Keysight's proprietary DDS developed for high-end signal generators achieves both extremely low phase noise, -122 dBc/Hz at 100 kHz offset at 10 GHz carrier (typical) and low spur levels, < -80 dBc (typical). The new sources improve the phase noise by 30 dB and also measurements that require input signals with low phase noise such as close two-tone IMD measurements.

The new sources with DDS with very low phase noise make phase measurements more stable and improves the measurement performance of some applications that require stable phase noise measurements: SMC+phase, differential IQ, true mode stimulus analysis.

Option UNY Enhanced low phase noise improves the phase noise performance of the new standard PNA/PNA-X by 10 dB or better, -131 dBc/Hz at 100 kHz offset at 10 GHz carrier (typical). The phase noise performance is comparable to the low phase noise option of high-performance analog signal generators like Keysight PSG with Option UNY mode 1.

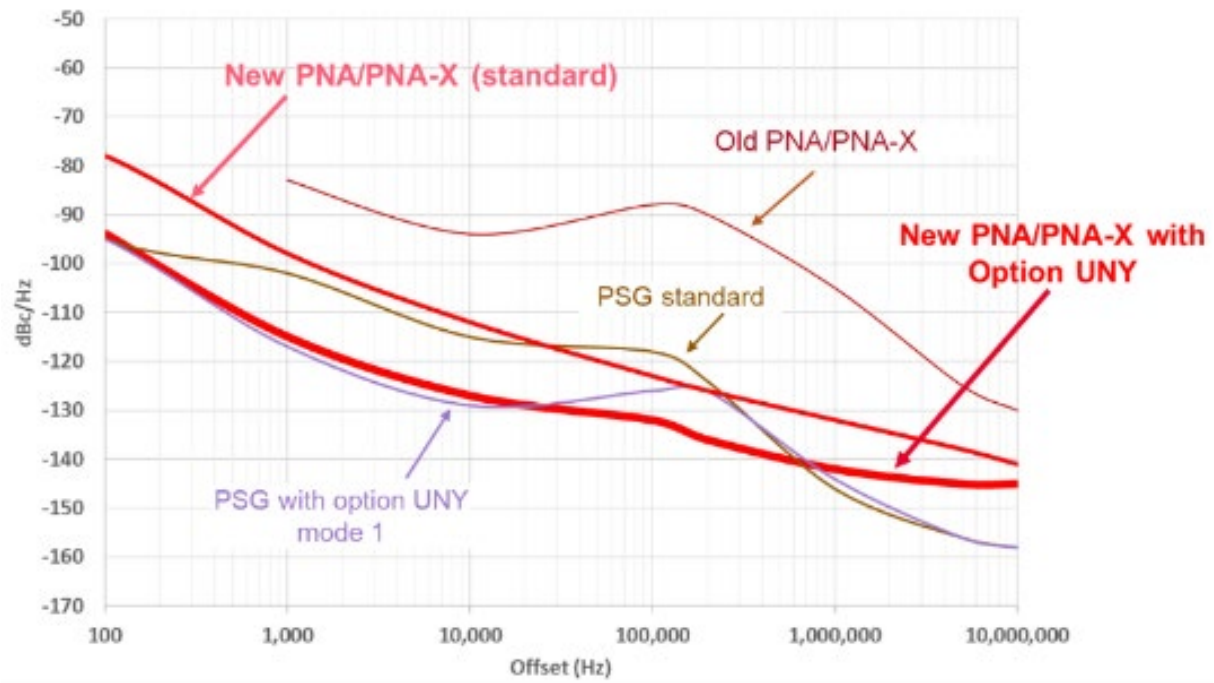

10 GHz phase noise comparison

Innovative Applications

Powerful measurement setup assistance, Device Measurement eXpert (DMX) (S94601B/S94602B)

Measurement challenges

- Inexperienced users find it difficult to setup complex measurements
- PNA is so flexible/capable that the users need to have a lot of knowledge/ experience to optimally set up the measurement.
- When making a number of different measurements for active devices (noise figure, gain compression, IMD...), there are many common settings that the users have to repeatedly configure for each measurement.
- The users need to know the limits of the instrument performance as well as the operating conditions of their DUTs to set up measurements in a safe and optimal manner.

Device Expert and S94601B DMX (Device Measurement eXpert) application

- Helps the users to set up the measurements automatically based on selected DUT. Device Expert, included with the base PNA software, provides three DUT types: low noise amplifier, mixer, and bandpass filter. The S94601B DMX provides many more DUT types than the built-in Device Expert. Once a DUT is selected the measurements and parameters configured in the template are listed. The users can modify the measurements and parameters using S94601B DMX or the DMX template editor.
- Assists the users in consistently configuring measurement settings throughout the design and test workflow by using a common template.
- Allows the users to create customized templates for their measurement needs.
- Provides intelligent algorithms that optimize measurement setups based on instrument and DUT performance limitations, protecting both the DUT and the instrument.

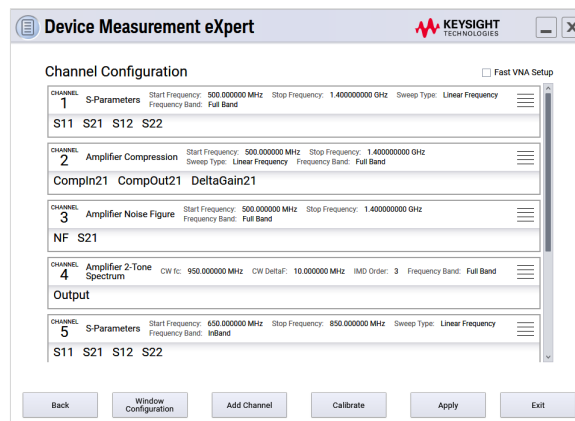
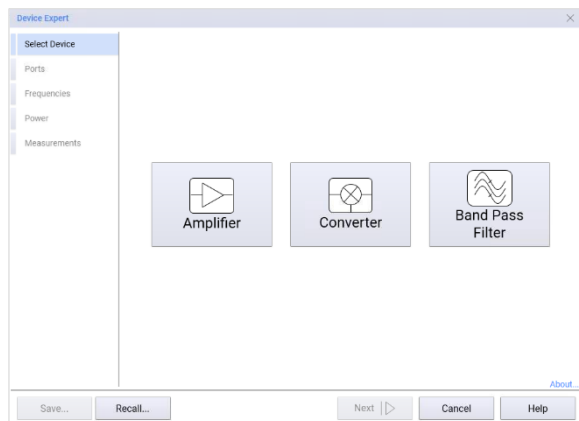

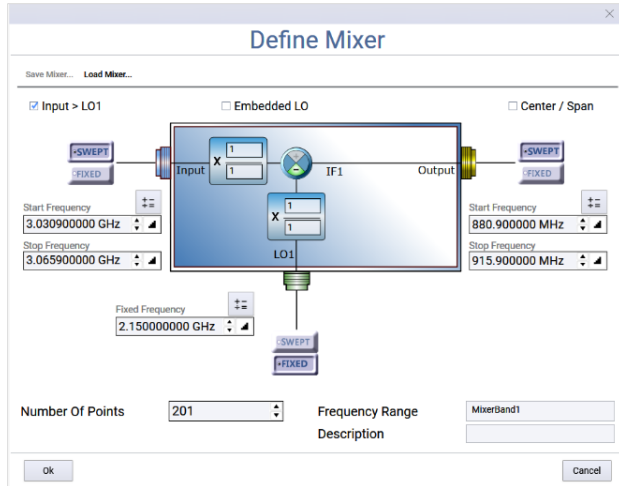

DMX Limit Assistant application (S94602B)

- Allows the users to acquire the data from a PNA or data file in csv, s2p or prn format and easily generate limit masks for complex limit test conditions with an intuitive and convenient graphical interface for production test applications

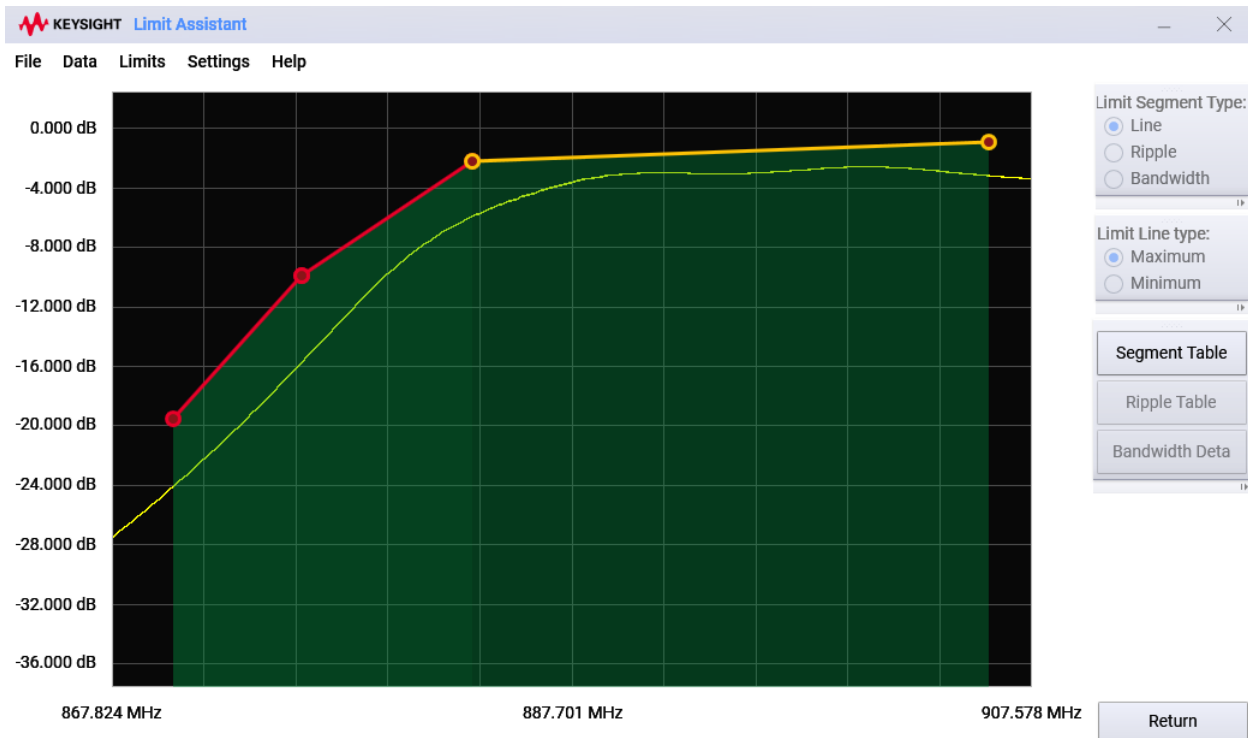

Network Analyzer Test Setup Assistant (S94605B)

Helps users with setting up and calibrating complex measurements with a spreadsheet-based measurement configuration assistant for a multiport DUT with a VNA based system and reduces the test development time.

Tips from the Experts

- The more details you put in the template, the less decisions and data entry operators will have to make when using the DMX wizard.
- When setting up measurements for a mixer/converter, use the save option to store your mixer frequency setup. You can then simply load the mixer setup anytime you need to reference the same mixer.

The image shows a Microsoft Excel spreadsheet and the Keysight Network Analyzer Test Setup Assistant software interface. A red arrow points from the spreadsheet to the software window.

Spreadsheet Data:

# Channel	Measurement Class	Sheet Title	Window Title	Sweep Type	Freq Start	Freq Stop
1	Standard	SP1	S-Parameters 1	Linear	1000000000	1000000000
2	Standard	SP2	S-Parameters 2	Segment		
3	Standard	SP3	S-Parameters 3	Linear	1000000000	1000000000
4	Standard	SP4	S-Parameters 4	Linear	1000000000	1000000000
5	Standard	SP5	S-Parameters 5	Linear	1000000000	1000000000
6	Standard	SP6	S-Parameters 6	Linear	1000000000	1000000000
7	Standard	SP7	S-Parameters 7	Linear	1000000000	1000000000
8	Noise Figure Cold Source	NF1	Noise Figure 1	Linear	1000000000	5000000000
9	Noise Figure Cold Source	NF2	Noise Figure 2	Linear	5000000000	10000000000
10	Noise Figure Cold Source	NF3	Noise Figure 3	Linear	10000000000	18000000000
11	Spectrum Analyzer	SA1	Spectrum Analysis 1	Linear	10000000000	10000000000
12	Spectrum Analyzer	SA2				

Software Interface (Network Analyzer Test Setup Assistant):

- Application Selection:** State Setup
- VISA Address:** 40883-hislip_PXIO_CHASSIS1_SLOT4_II
- I/O Timeout (ms):** 10000
- Setup Files:** C:\Program Files\Keysight\NTSA\Example Spreadsheets\State\Channel_...; C:\Program Files\Keysight\NTSA\Example Spreadsheets\State\Trace_Sp...
- I/O Type:** Command
- Content:** SENSI:PULS0:DEL 1E-07; SENSI:PULS0:WIDT 1E-06; SENSI:PATH:CONF:ELEM 'PulseTrigInput,External'; SENSI:PATH:CONF:ELEM 'PulseModDrive,RearPanel'; SENSI:PULS:TYP Edge; SENSI:PULS:TPOI Positive; SOUR1:POW:COUP ON; SENSI:AVR:MODE POINT; SENSI:BAND:RES 50000; SENS:CONT ON; SENSI:CONT:MACR BEF, ON; SENSI:CONT:MACR:COMM BEF-TestExtSwitch PATH 'Path1'; DISP:WIND2:STAT 1; DISP:SHE:ARR WIND; CALC2:MEAS19:DEF 'b1_1-Standard'; SENS2:SWE:MODE HOLD; DISP:MEAS19:FEED 2
- Buttons:** Add, Remove, Start, Clear
- Status:** Ready
- Timestamp:** 01/27/2022 11:02:30

Innovative Applications

Real-time S-parameter and power measurement uncertainty (S93015B)

Product performance verification challenges

- Need to calculate the measurement uncertainty including multiple uncertainty factors
- Hard to optimize limit lines for pass/fail tests
- Quality control procedure is not simple due to complexity of quantifying the quality of the measurement process.

PNA-X's real-time S-parameter and power measurement solution

- Provides real-time S-parameters and power measurements uncertainty on the display
- Enables more realistic limit lines and reduce the defect percentage on the finished products for better production yield rates
- Includes the calibration standard uncertainty and provides the national metrology institute traceability
- Establishes a metric to quantify the quality of the measurement process for quality- control-procedure simplification
- Helps to include uncertainty information to the users' product specifications and datasheets
- Allows users to save measurement data and evaluate other parameters with fully correlated uncertainty

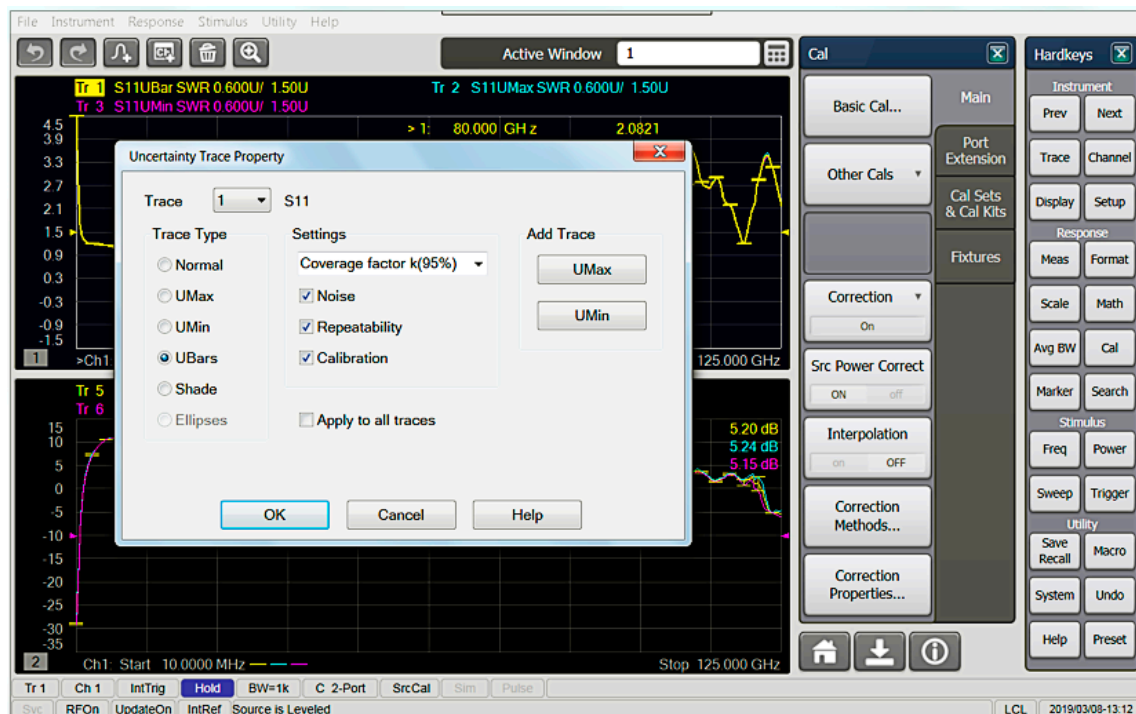

S93015B uncertainty model includes multiple uncertainty factors: noise, calibration standards, power sensor, and repeatability.

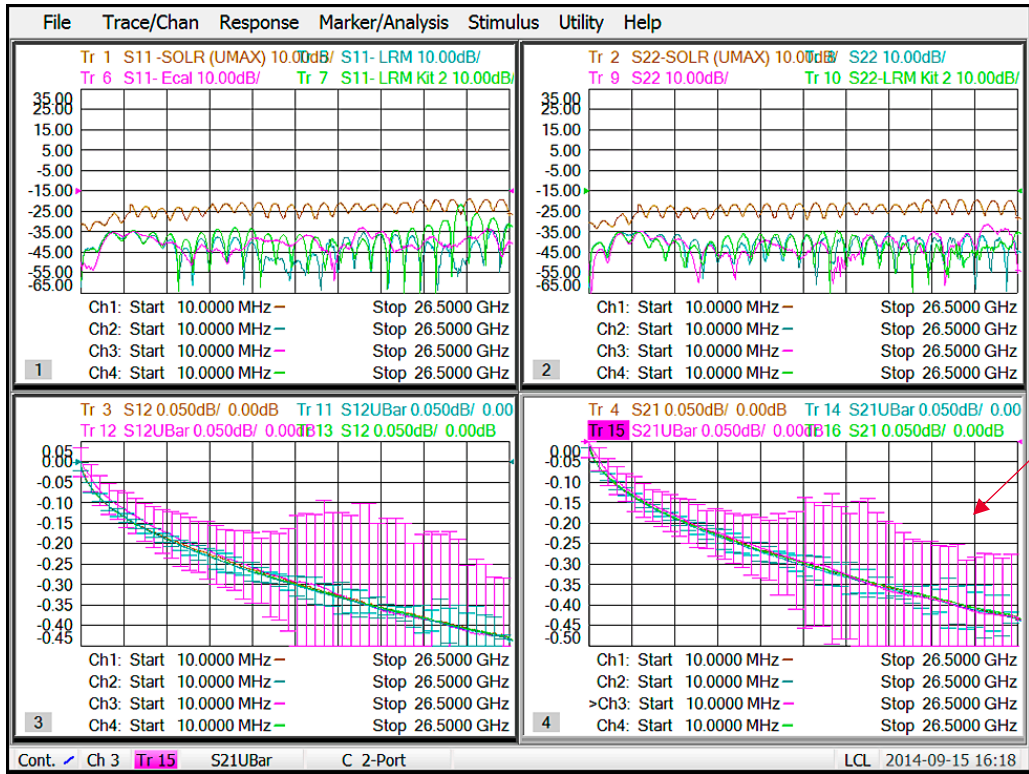

Error (uncertainty) bars are given on the measurement traces

Real time uncertainty with measurement traces and uncertainty bars

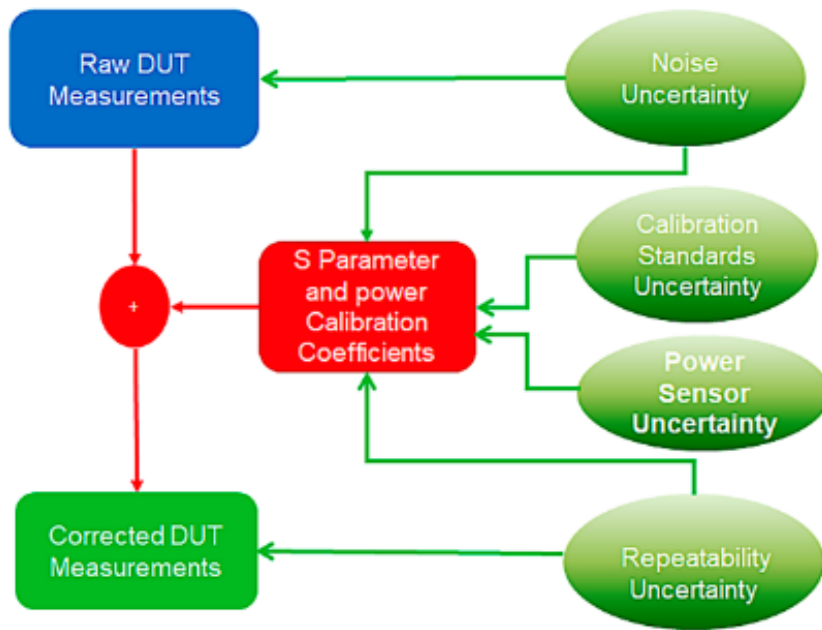

The users can select the uncertainty factors and the coverage factors depending on the application.

Tips from the Experts

- Prior to using the uncertainty calibration, ensure that you have set up the correct number of points, IFBW and power for the device you want to measure. This will avoid invalidation of your uncertainties as a result of changing any of these parameters after doing a calibration.
- It is recommended that you do a standard calibration prior to using the Uncertainty Manager, as this will make it more efficient when you start the repeatability-characterization process.
- When using the uncertainty manager to characterize the repeatability of the measurement, consider providing a unique label for each port. This way you can save the noise and repeatability for each of the ports you will be using in the final measurement. As an example, use "Lab System Port 1" as the cable name and assign the appropriate connector.
- When viewing 1-port uncertainties, it is best to use the linear format as opposed to the log format.

Innovative Applications

Simple, fast and accurate pulsed-RF measurements (S93025/026B, Options 021, 022)

Pulsed-RF measurement challenges

- Pulse generators and modulators required for pulsed-RF measurements add complexity in test setups
- For narrow pulses:
 - Maximum IF bandwidth of analyzer is often too small for wideband detection
 - Narrowband detection is slow, and measurements are noisy for low-duty-cycle pulses

PNA-X pulsed-RF measurements provide:

- S93025B provides a simple user interface for full control of two internal pulse modulators (Options 021 and 022), four internal independent pulse generators, and point-in-pulse measurements with pulse widths as narrow as 200 ns, and pulse-profile measurements with 50 ns minimum resolution
- S93026B adds point-in-pulse measurements with 20 ns minimum pulse width, and pulse profile measurements with 10 ns minimum resolution
- Improved measurement speed and accuracy for narrowband detection using hardware filters and patented spectral-nulling and software IF-gating techniques
- Measurements using wideband detection with pulse widths as narrow as 100 ns
- Pulse I/O connector on rear panel for synchronization with external equipment and DUT
- Accurate active-component characterization using unique application measurement classes for gain compression, swept-frequency/power IMD, and noise figure



Figure 1. By the 1990s, the HP 8510 was the industry-standard for pulsed-RF vector network analyzers



Figure 2. The PNA Series replaced the pulsed 8510 with a bench-top solution.



Figure 3. Providing the first one-box pulsed-RF test system, the PNA-X sets a new standard for simplicity, speed, and accuracy.

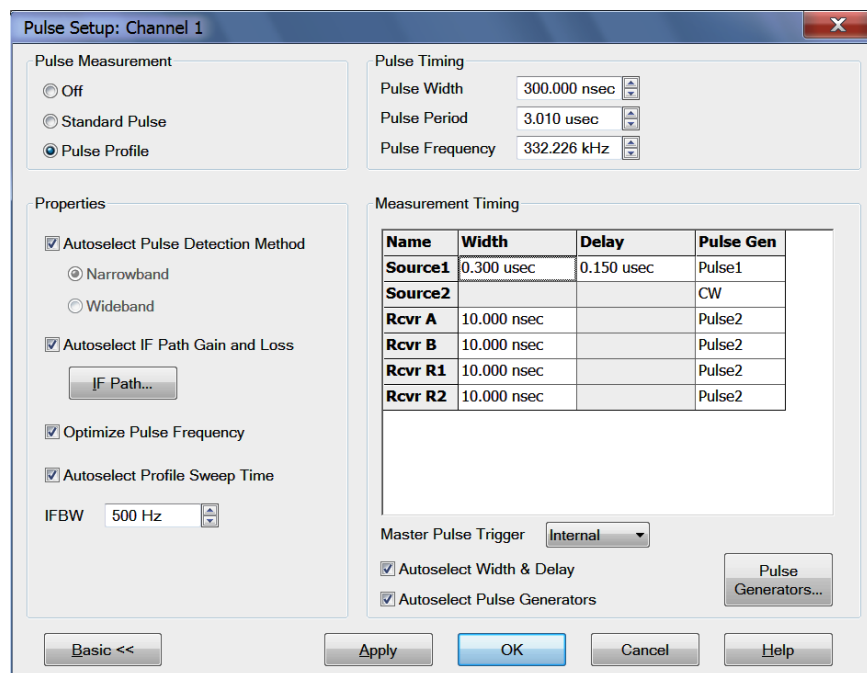

Figure 4. Pulsed-RF measurement application automatically optimizes internal hardware configuration for specified pulse conditions to dramatically simplify test setups. Alternately, users can choose to manually set up the hardware for unique test requirements.

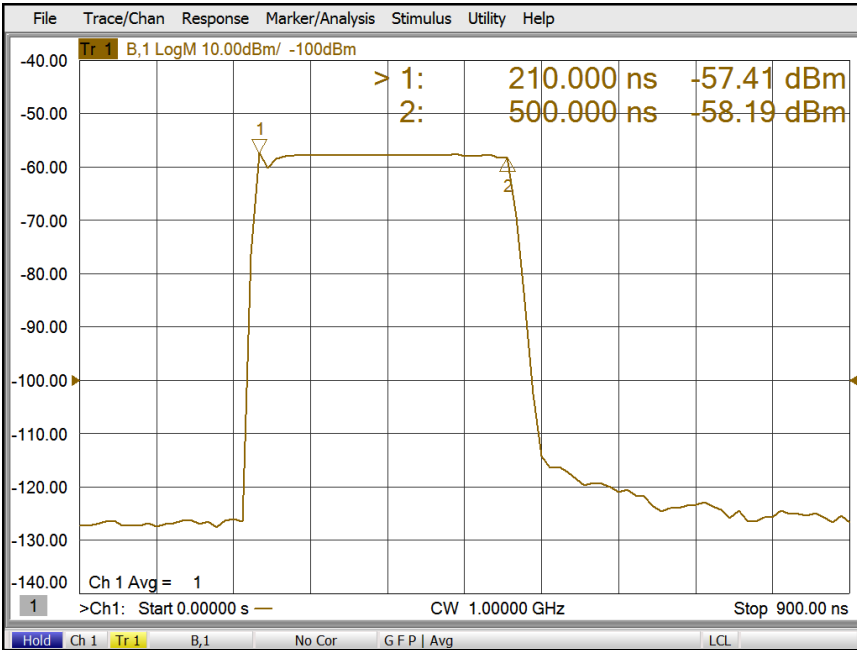
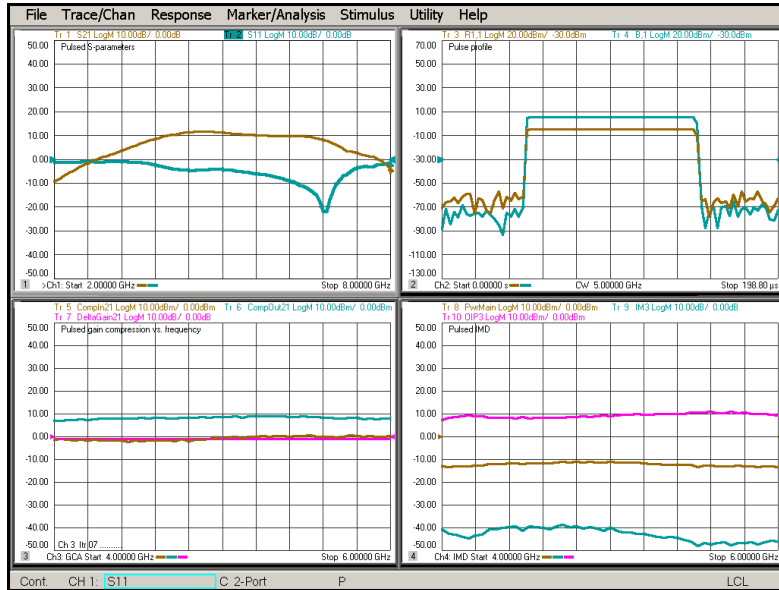

Figure 5. Pulse profile measurement using narrowband detection technique allows 30 measurement points within 300 ns pulse, with 10 ns timing resolution.

Tips from the Experts

- Compared to sweep averaging, point averaging typically provides faster results when averaging is needed to lower noise and improve accuracy of measurements using wideband detection.
- During source power calibrations, power sensors read the average power, while the analyzer sets the peak power of the pulsed stimulus. To compensate for the difference between the peak and average power, use the power offset feature with the value of $10 \log$ (duty cycle).
- The minimum pulse width for point-in-pulse measurements using wideband detection is determined by the number of samples required for the IF bandwidth (IFBW). For example, the minimum pulse width is 100 ns with 15 MHz IFBW, 300 ns with 5 MHz IFBW, and 1.44 μ s with 1 MHz IFBW. When working at the minimum pulse width for a particular IFBW, it is important to precisely set the measurement delay (with 10 ns resolution) to align the pulse modulation and the data acquisition period.
- In pulse mode, it is important to use receiver leveling to maintain power-level accuracy for power-dependent measurements, such as output power, compression, and intermodulation distortion.

PNA-X's narrowband detection method used for narrow pulse widths (< 267 ns) employs special hardware and patented software-gating techniques to improve system dynamic range for low-duty-cycle measurements by 40 dB compared to PNA-based pulsed-RF systems.



The PNA-X accurately characterizes active devices under pulsed operation with a single set of connections to the DUT— pulsed S-parameters, pulse profile (input and output power in the time domain), gain compression versus frequency, and swept-frequency IMD are measured in this example

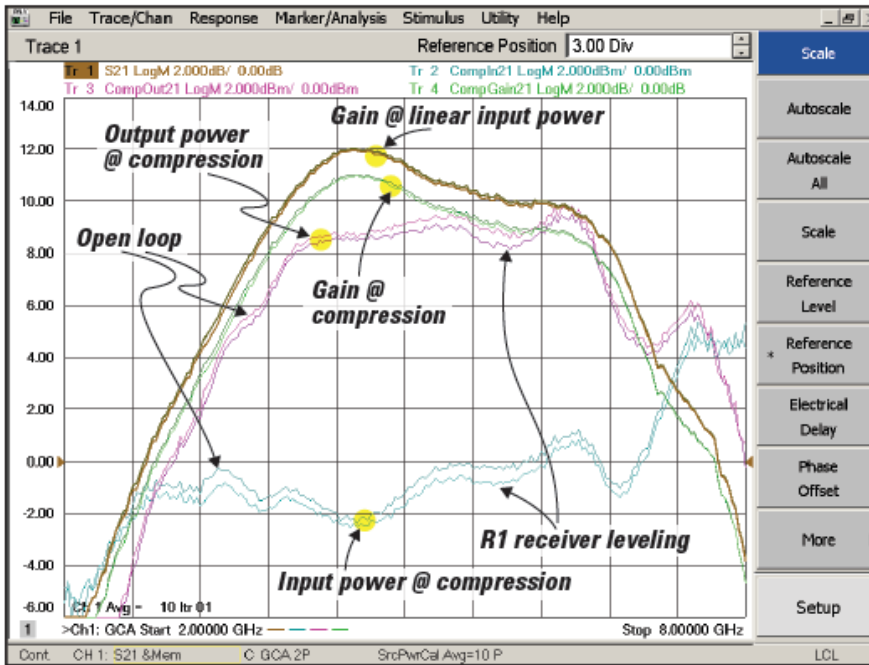

Using receiver leveling improves the pulsed-RF power accuracy from ± 1 dB to less than 0.05 dB.

Above measurements compare the results with and without receiver leveling in GCA measurements. Inaccurate stimulus causes large errors in power-dependent measurements such as input and output power at the compression point versus frequency

Innovative Applications

Fast and accurate noise figure measurements (S93029B, Option 029¹/E29²)

Noise figure measurement challenges with traditional, Y-factor approach

- Multiple instruments and multiple connections required to fully characterize DUT
- Measurement accuracy degrades in-fixture, on-wafer, and automated-test environments, where noise source cannot be connected directly to DUT
- Measurements are slow, often leading to fewer measured data points and misleading results due to under-sampling

PNA-X noise figure solution provides:

- Amplifier and frequency converter measurements with the highest accuracy in the industry, using advanced error-correction methods
- Fast measurements: typically, 4 to 10 times faster than Keysight's NFA Series noise figure analyzers
- Ultra-fast noise-parameter measurements when used with Maury Microwave automated tuners, giving 200 to 300 times speed improvements

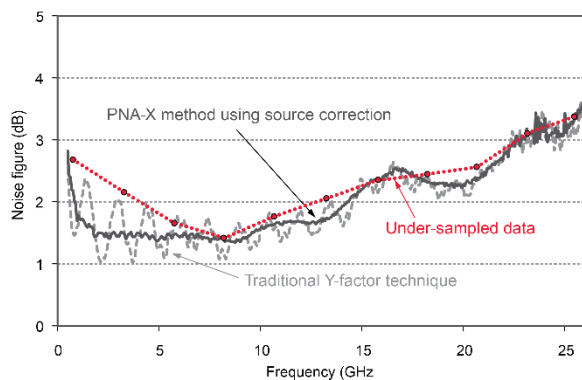

For this 401-point measurement of an unmatched transistor, the PNA-X exhibits much less ripple compared to the Y-factor method. The NFA default of 11 trace points would give under-sampled and therefore misleading results of the amplifier's performance.

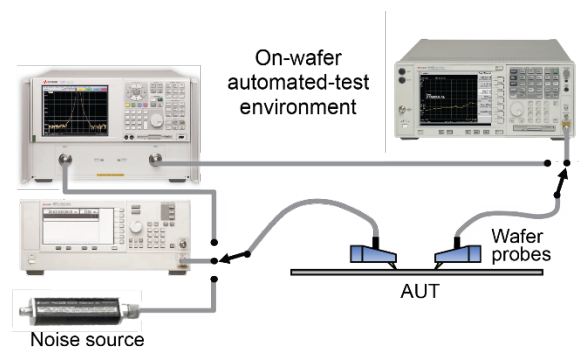

For Y-factor measurements, any electrical network connected between the noise source and the DUT, such as cables, switch matrices, and wafer probes, causes significant accuracy degradation.

1. Option 029 Low-noise receiver is available only on N524xB PNA-X.
2. Option E29 Low-noise receiver to 67 (70) GHz available only on N5247B PNA-X.

I have several instruments in my equipment pool that can measure noise figure— 8970s, NFAs, and spectrum analyzers. My biggest problem for noise figure measurements was lack of correlation—I'd get different answers depending on which instrument I used. Now, with the PNA-X's high accuracy, I know I'll get the right answer every time, no matter which PNA-X I use.

Test Engineering Manager

Noise figure measurement methods

Y-factor: The most prevalent method for measuring noise figure is the Y-factor technique. It relies on a noise source connected to the input of the device under test (DUT). When the noise source is turned off, it presents a room temperature (cold) source termination. When the noise source is turned on, it creates excess noise, equivalent to a hot source termination. Under these two conditions, noise power is measured at the output of the DUT, and the scalar gain and noise figure of the amplifier is calculated. The Y-factor method is used by Keysight's NFA Series and by spectrum analyzers with preamplifiers and a noise figure personality option.

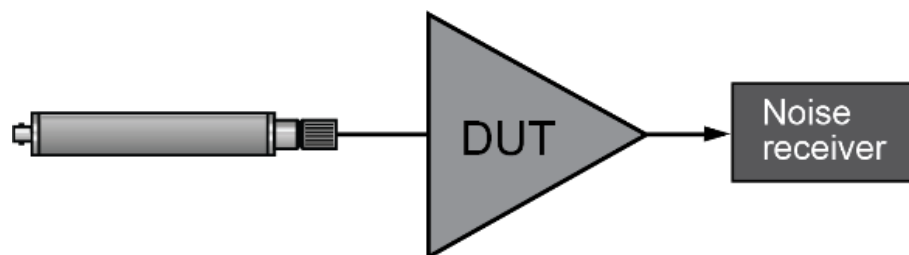

Cold Source: An alternate method for measuring noise figure is the cold source or direct noise technique. With this method, only one noise power measurement is made at the output of the DUT, with the input of the amplifier terminated with a room temperature source impedance. The cold source technique requires an independent measurement of the amplifier's gain. This technique is well suited for vector network analyzers (VNAs) because VNAs can measure gain (S₂₁) extremely accurately by utilizing vector error correction. The other advantage of the cold source method is that both S-parameter and noise figure measurements can be made with a single connection to the DUT.

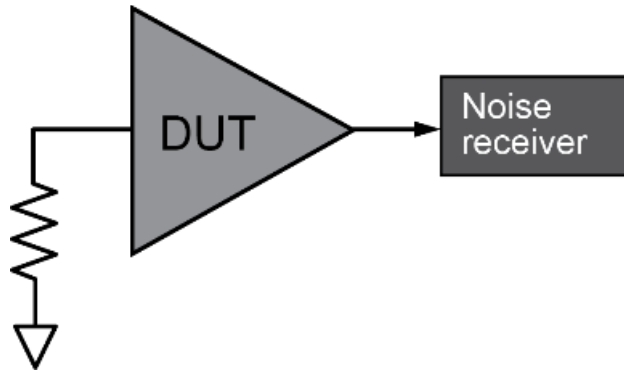

PNA-X's unique source-corrected noise figure solution

- Uses modified cold-source method, eliminating need for noise source when measuring DUT
- Corrects for imperfect system source match by using vector correction to remove mismatch errors plus an ECal module used as an impedance tuner to remove noise-parameter-induced errors
- Maintains high measurement accuracy in fixtured, on-wafer, or automated-test environments
- Accurately measures differential devices using vector de-embedding of baluns or hybrids

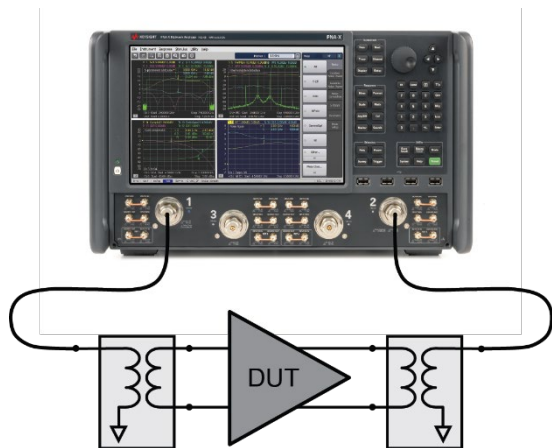

Measure differential devices by de-embedding baluns or hybrids.

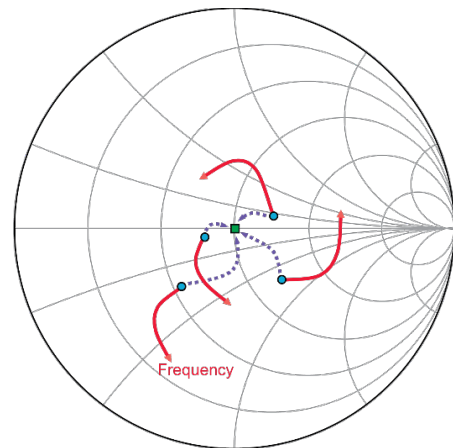

At each test frequency, four or more noise measurements are made with known, non-50-ohm source impedances. From these measurements, 50-ohm noise figure is accurately calculated.

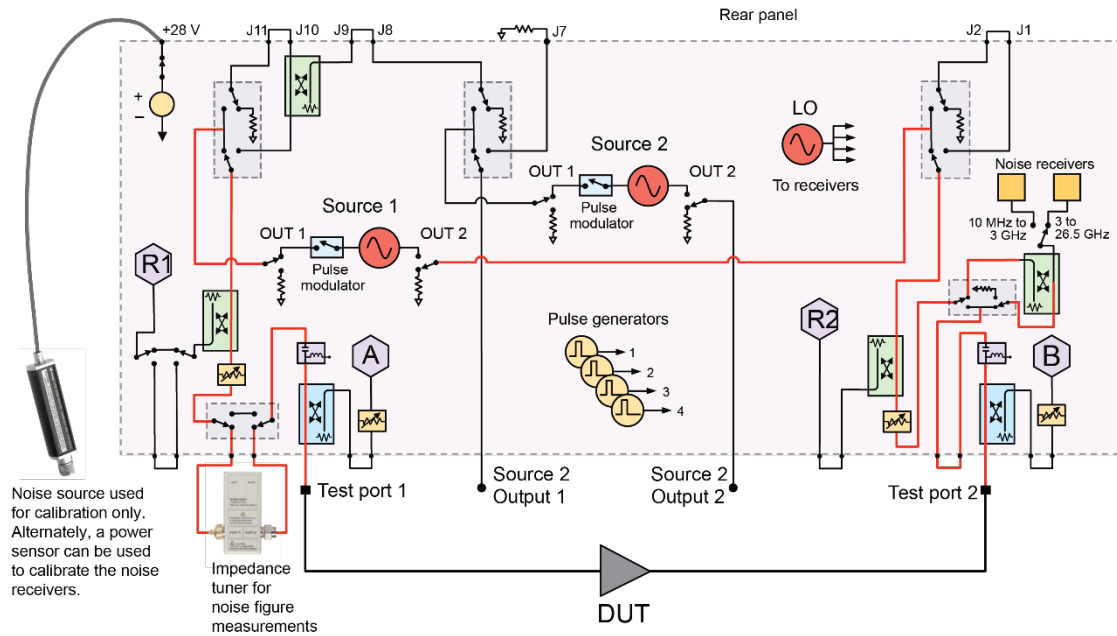

Noise source used for calibration only. Alternately, a power sensor can be used to calibrate the noise receivers.

Block diagram of a two-port N5242B PNA-X with test set option 224, and low-noise receiver option 029. A standard ECal module is used as an impedance tuner to help remove the effects of imperfect system source match. N5244/45/47B models include a built-in impedance tuner.

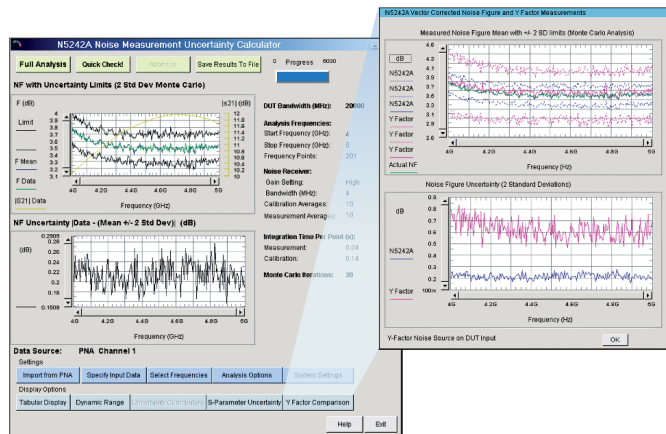

Keysight's PNA-X noise figure uncertainty calculator (www.keysight.com/find/nfcalc) includes the effects of mismatch and noise-parameter-induced errors caused by imperfect system source match.

Tips from the Experts

- Noise figure measurements are best done in a screen room to eliminate spurious interference from mobile phones, wireless LAN, handheld transceivers, etc.
- Batteries are sometimes used instead of mains-based power supplies to eliminate conducted interference from sensitive LNA measurements
- Overall measurement accuracy can be estimated by using Keysight's Monte-Carlo- based noise figure uncertainty calculator

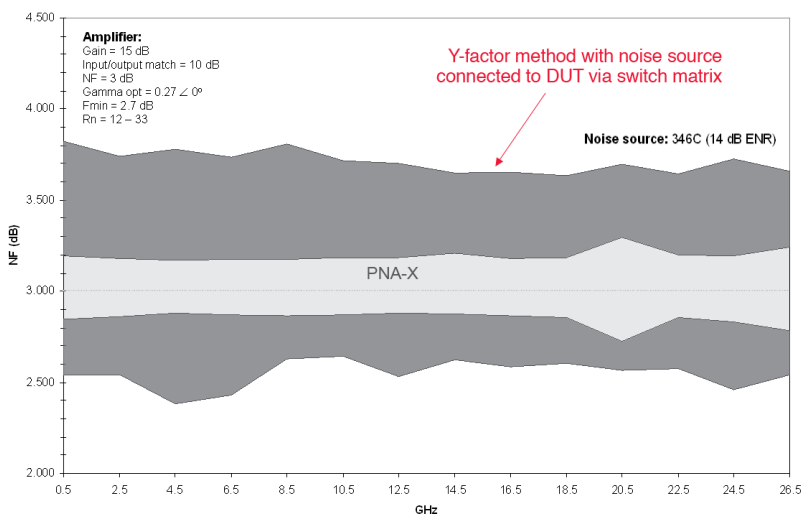

Noise figure measurement uncertainty example in an automated test environment (ATE). The PNA-X's source corrected technique is considerably more accurate than the Y-factor method.

Innovative Applications

Fast and accurate noise parameter measurements for unmatched devices (S93027B, S93029B, Option 029) (PNA-X only)

Unmatched devices noise parameter measurement challenges

- An ECal module as an impedance tuner works fine for 50-ohm devices like packaged amplifiers, but it does not work well for non-50-ohm devices like unpackaged, on-wafer amplifiers.
- A mechanical impedance tuner is needed for noise figure measurement for various impedance states



Block diagram of a four-port N5245B PNA-X with test set option 423, and low-noise receiver option 029. A Maury Microwave's LXI tuner is used as an impedance tuner to provide a wide range of source impedances.

PNA-X's noise parameter measurement for unmatched devices

- Noise parameter measurements of unmatched devices with $\gamma_{\text{opt}} < 0.9$
- Use Maury Microwave's LXI tuner as the impedance tuner instead of ECal module
- The software application, S93027B controls the LXI tuner to generate various source impedance states for noise parameter measurements.
- Requires the low-noise receiver (Option 029) and the S93029B

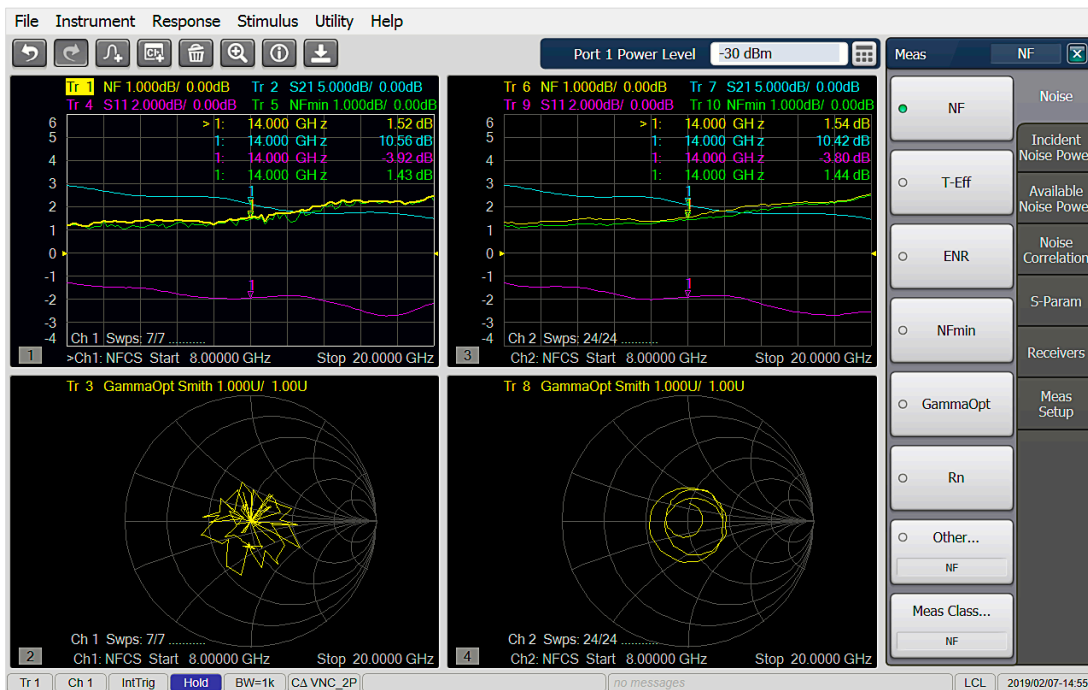
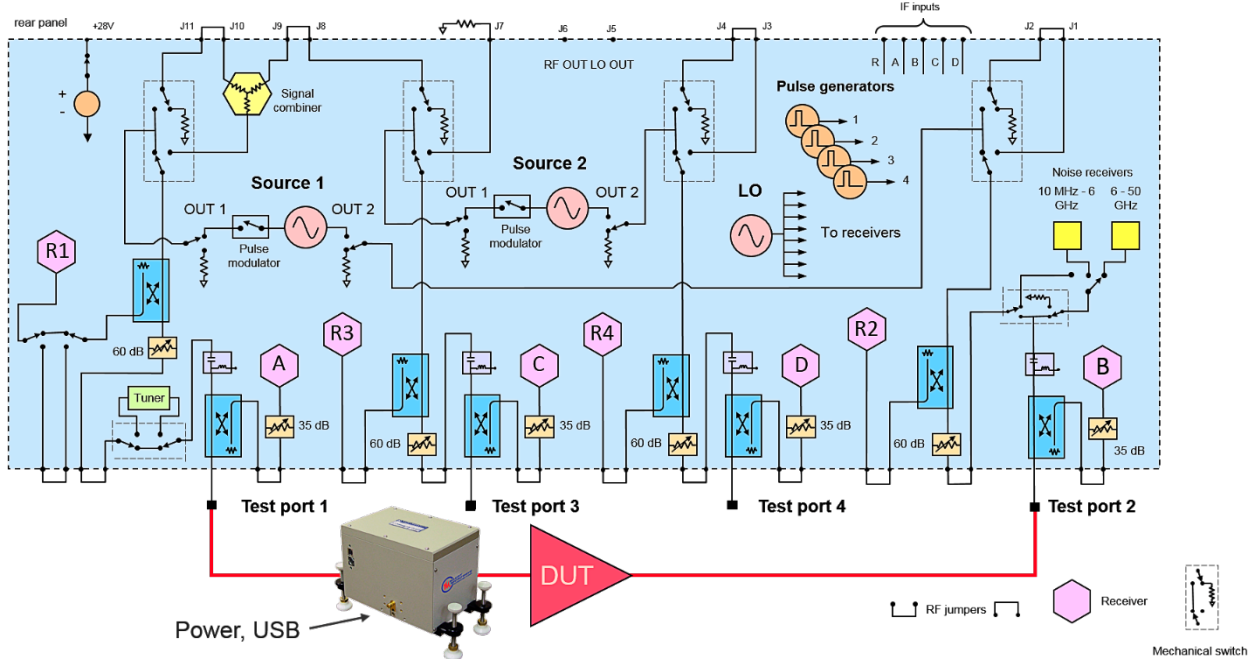

ECal

Maury LXI tuner

Unmatched device noise parameter measurements with ECal as impedance tuner vs with Maury LXI tuner as impedance tuner. For available Maury LXI tuners, contact Maury Microwave. www.maurymw.com

Innovative Applications

Fast and accurate gain compression versus frequency measurements of amplifiers and converters (S93086B)

Gain compression measurement challenges

- Characterizing amplifier or frequency converter compression over its operating frequency range requires measurements at many frequency and power points, so setting up the measurements, calibration, and data manipulation takes a lot of time and effort
- A variety of errors degrade measurement accuracy, such as mismatch between the test port and the power sensor and DUT during absolute power measurements, and using linear S-parameter error correction in nonlinear compression measurements

PNA-X's noise parameter measurement for unmatched devices

- Fast and convenient measurements with SMART Sweep
- Highly accurate results using a guided calibration that provides power and mismatch correction
- Complete device characterization with two-dimensional (2D) sweeps, with the choice of sweeping power per frequency, or sweeping frequency per power
- Flexibility with a variety of compression methods — compression from linear gain, maximum gain, X/Y compression, compression from back-off, or compression from saturation

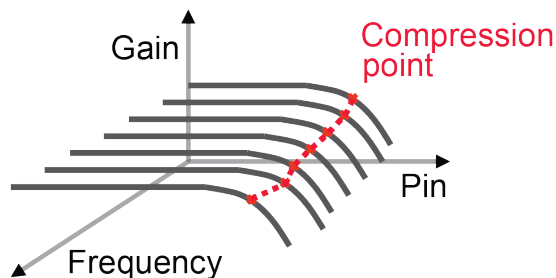

A network analyzer is commonly used for gain compression measurements by performing power sweeps at multiple CW frequencies. The PNA-X's GCA makes it easy to characterize compression over the DUT's operating frequency range with extreme speed and accuracy, and a simple setup.

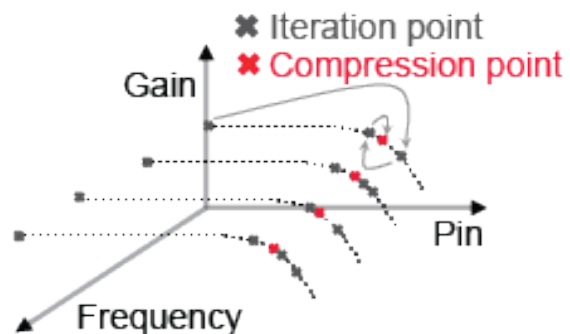

Instead of a linear power sweep with many points, GCA's SMART Sweep uses an adaptive algorithm to find the desired compression point at each frequency with just a few power measurements, thus significantly reducing test times.

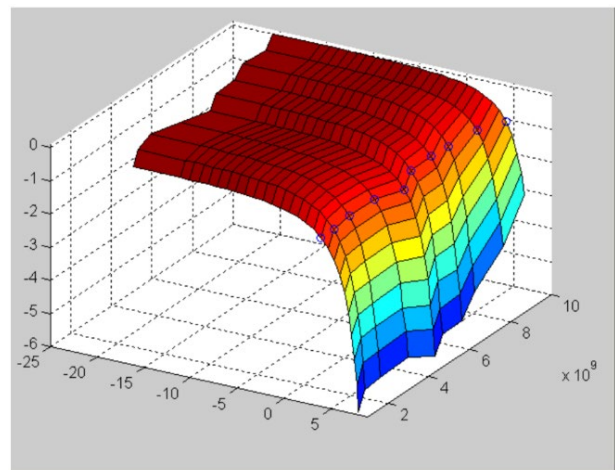
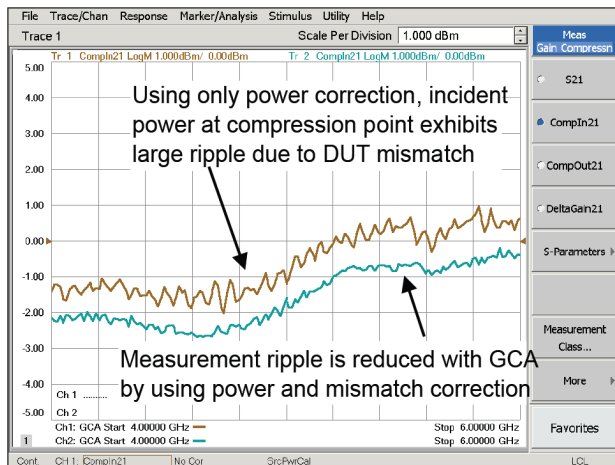

Complete device response to 2D sweeps — gain versus frequency and power — can be extracted for device modeling.

Tips from the Experts

- Use the safe mode in SMART Sweep to increment the input power first with coarse and then with fine steps to prevent over driving the DUT
- When the DUT's hysteresis or thermal effects are in doubt, it is recommended to sweep frequency per power rather than power per frequency, or to add dwell time to lower the effects from previous measurements
- Compression analysis capability extracts the DUT response over the power range at a specified frequency point on any of the compression traces
- Use the CompAll and CompAl2 internal voltmeter readings that are synchronized to the compression point to measure power-added efficiency (PAE) at compression for each frequency

Available compression methods

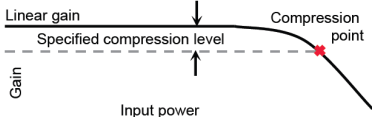
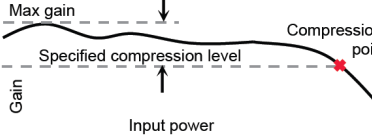
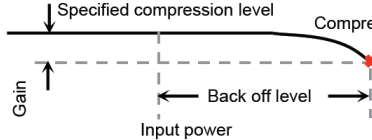
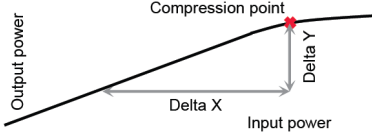
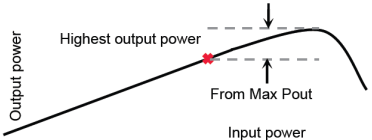
Compression from linear gain	The linear gain is measured using the specified linear (input) power level. The compression point is calculated as the linear gain minus the specified compression level.	
Compression from max gain	The highest gain value that is found at each frequency is used as the max gain. The compression point is calculated as the max gain minus the specified compression level.	
Compression from back off	The gains at two input powers that are different with the specified back off level are compared. The compression point is found as the highest input power with the gain difference of the specified compression level.	
X/Y compression	The output powers at two input powers that are different with the specified delta X are compared. The compression point is found as the highest input power with the output power difference of the specified delta Y.	
Compression from saturation	The compression point is found at the highest output power minus the value specified as "From Max Pout".	

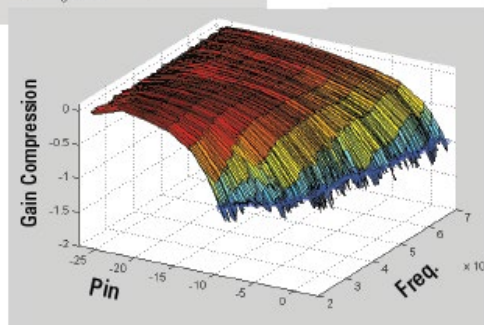
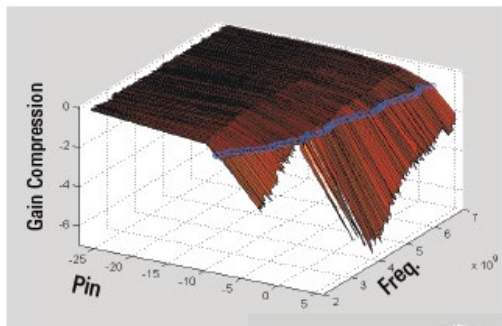

Measured background data in SMART Sweep with Safe Mode Off (above) and On (below)— more iterations are used as the gain becomes closer to the 1 dB compression point with Safe Mode On, which minimizes excess drive power.

Innovative Applications

Fast two-tone intermodulation distortion (IMD) measurements with simple setup (S93087B)

IMD measurement challenges

- Two signal generators, a spectrum analyzer, and an external combiner are most commonly used, requiring manual setup of all instruments and accessories
- Test times are slow when swept-frequency or swept-power IMD is measured
- Instruments and test setups often cause significant measurement errors due to source-generated harmonics, cross-modulation, and phase noise, plus receiver compression and noise floor



The PNA-X with IMD application replaces two signal generators and a spectrum analyzer in the system rack, simplifying the system configuration and increasing test throughput.

PNA-X with IMD application provides:

- Fast swept IMD measurements of amplifiers and frequency converters, using internal combiner and two internal sources
- Quick and easy measurements with simplified hardware setup and intuitive user interface
- Guided calibration that simplifies the calibration procedure and provides high measurement accuracy
- Spectrum analyzer mode for troubleshooting or making spurious measurements, eliminating the need for a separate spectrum analyzer
- Very clean internal sources and wide receiver dynamic range, minimizing the measurement errors caused by other instruments

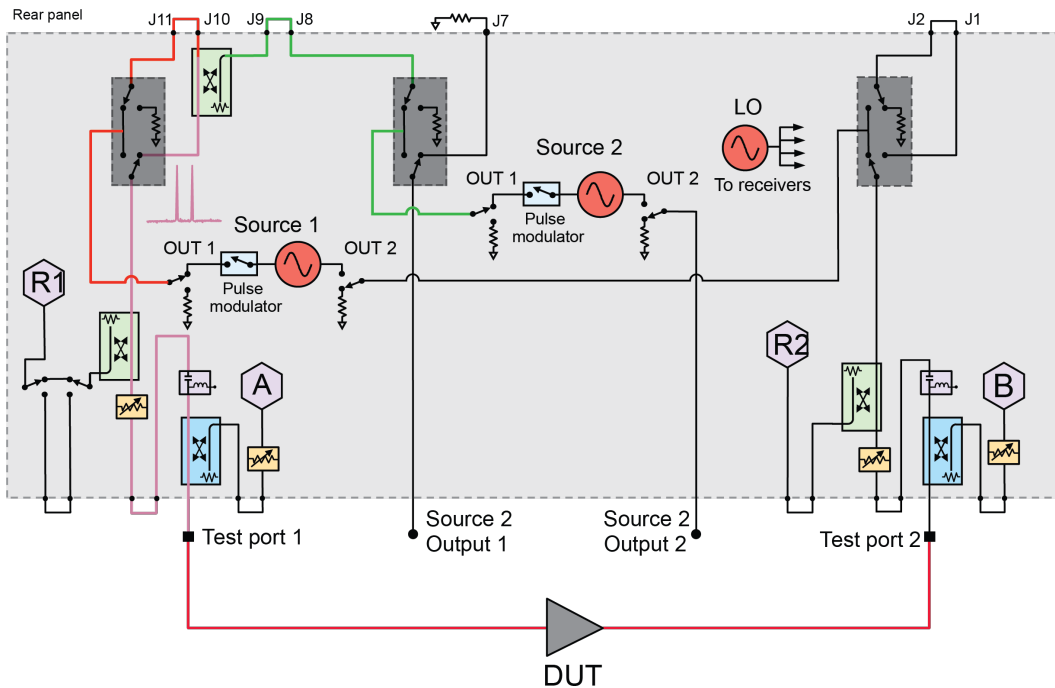

Two internal sources with high output power, wide ALC range, -60 dBc harmonics, and a high-isolation combiner, make the PNA-X an ideal instrument to drive the DUT for two-tone IMD measurements. Wide dynamic-range receivers with high compression points enable accurate measurements of low-power IMD products while the higher power main tones are present.

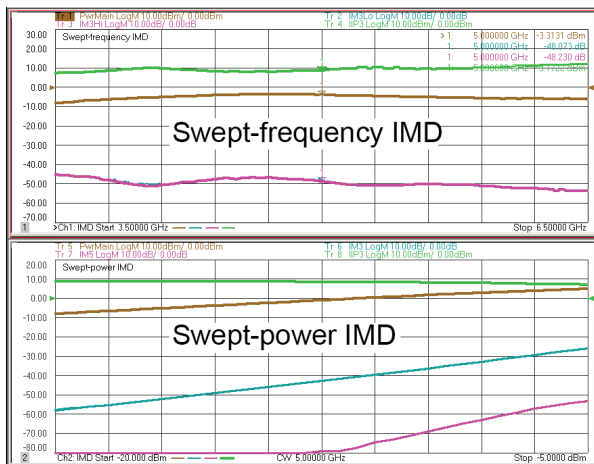

IMD application measures third order IMD and IP3 at 201 frequency (or power) points in a matter of seconds, compared to several minutes using signal generators and a spectrum analyzer.

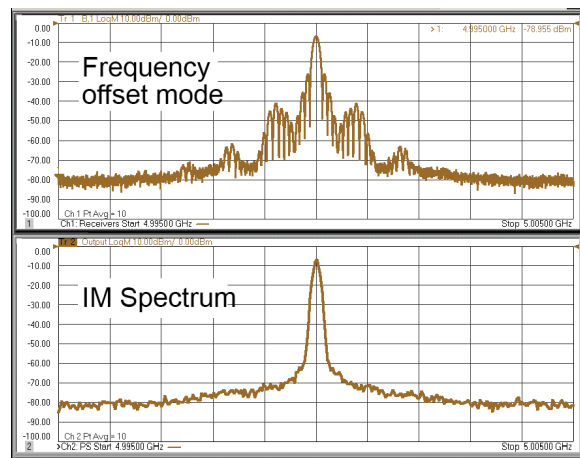

Frequency-offset mode is commonly available in VNA's, but conventional IF filter responses exhibit high side lobes. The IM Spectrum mode employs an optimized digital IF filter and provides true spectrum measurement capability in the PNA-X.

Swept IMD sweep types

	Sweep fc	Sweep Delta F	Power Sweep	CW	LO Power Sweep	Segments
Center Frequency	Swept	Fixed	Fixed	Fixed	Fixed	Swept (as defined by segment table)
Tone Spacing	Fixed	Swept	Fixed	Fixed	Fixed	Fixed
Tone Powers	Fixed	Fixed	Swept (coupled or uncoupled)	Fixed	Fixed	Fixed
z						
Diagram						

Tips from the Experts

- Calibrate at all measurement frequencies or at center frequencies only, trading off productivity and accuracy
- Let the PNA-X control external signal generators to greatly simplify swept IMD measurements of mixers and converters
- Use the Marker to IM Spectrum feature to show the spectrum at a specified point on the swept IMD trace
- Use point averaging with IM Spectrum, especially when using a wide resolution bandwidth, to reduce the noise deviation of the noise floor with minimum speed impact

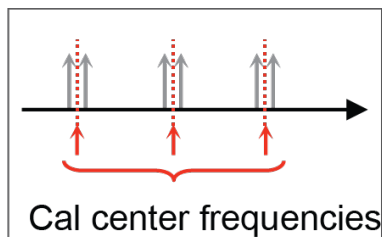
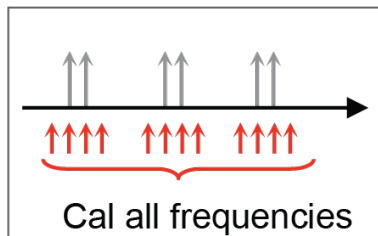

Calibrating all frequencies is recommended for wide tone spacing. Although the calibration takes longer with “all frequencies”, measurement speed is not affected.

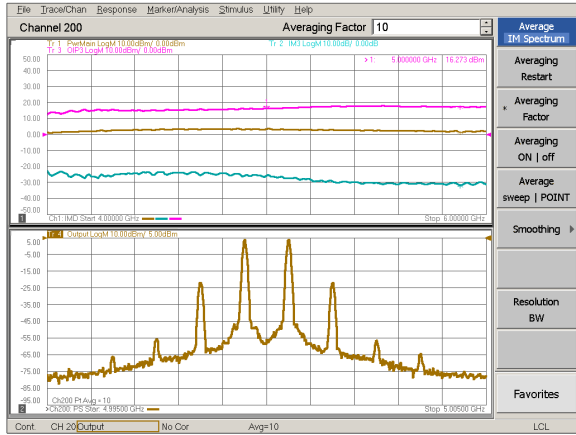

The IM Spectrum in the lower window shows the spectrum corresponding to the Swept IMD marker at the center of the trace in the upper window. Point averaging is applied to the IM Spectrum to reduce the noise deviation.

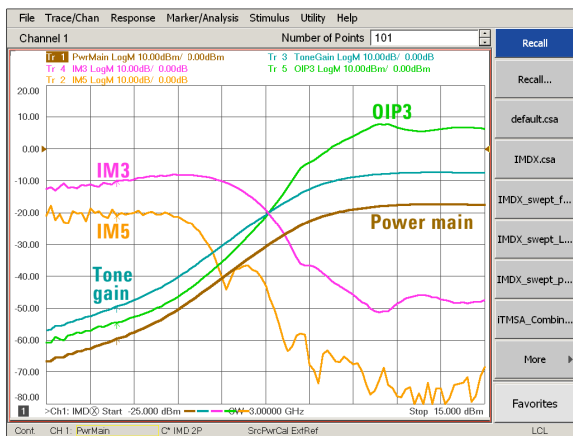

IMD and IP3 versus LO power yields maximum IP3 with lowest possible LO drive power. This helps specify the mixer setup to achieve maximum efficiency while minimizing power consumption.

The two-tone measurements in the image below compare the spectral purity of the previous signal source in PNA and that of the new DDS source in the current version of PNA with option UNY. The phase noise is much better and also the close-in spurious signals are essentially eliminated.

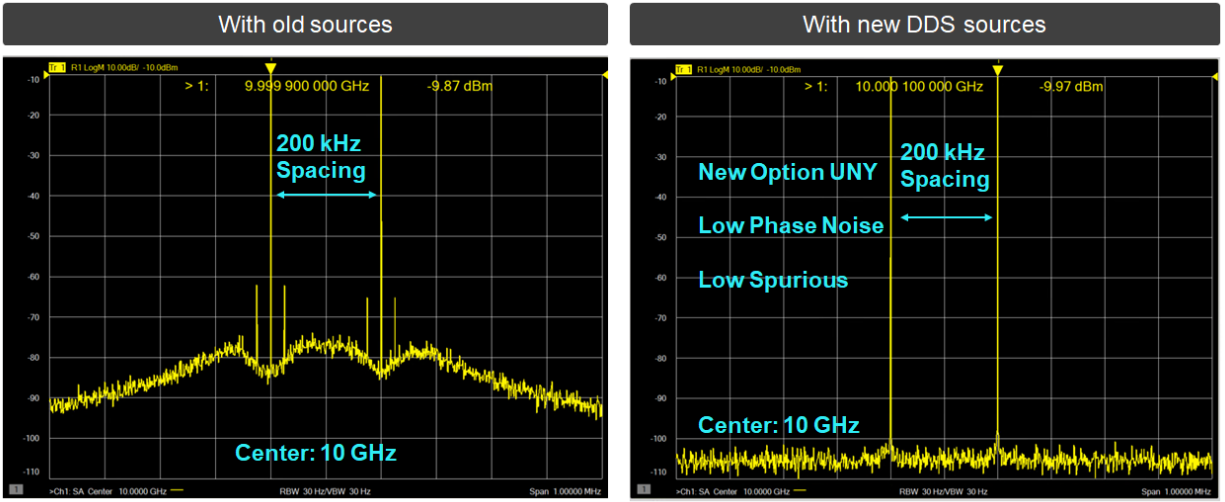

Figure 4. Two-tone measurements

Additional RF source port

A third RF source up to 13.5 GHz (option XSB) can be added to the N524xB 4-port PNA with option 422 or 423. The third source also has the same low-phase noise performance as the two internal RF sources. You can use it as the local source of the DUT for two-tone frequency converter measurements or two-stage frequency converter measurements. It eliminates the need of an external signal generator. You can also use it as an independent analog signal generator. For example, it can be used as the reference signal for a DUT that requires the external reference clock signal, and as the reference signal of another measurement instrument like Keysight’s UXG agile vector adapter. If you add both Option UNY and Option XSB, the 4-port PNA-X has three signal sources with extremely low phase noise performance. You gain the equivalent of three high-performance analog signal generators built in the 4-port PNA-X.

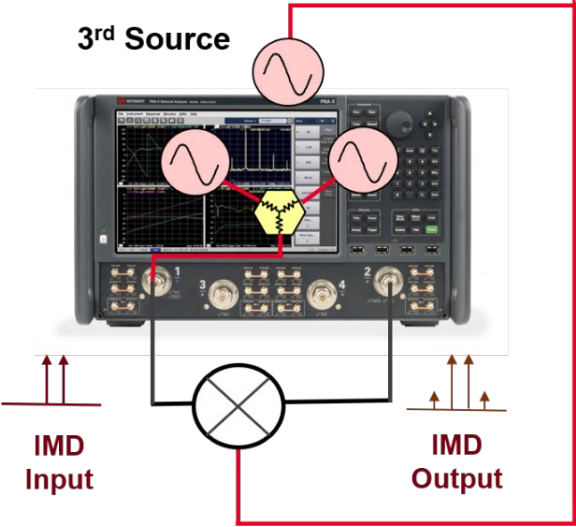

Figure 5. Two-tone IMD mixer measurement

Innovative Applications

Accurate characterization of mixers and converters (S93082/083/084B)

Mixer and converter measurement challenges

- Traditional approach with spectrum analyzer and external signal sources is cumbersome, slow, and does not provide phase or group delay information
- Conventional VNAs require an external signal source, which degrades sweep speed
- Conventional VNAs provide phase or group delay data relative to a “golden” device
- Attenuators are often used to minimize ripple due to input and output mismatch, at the expense of dynamic range and calibration stability



S93083B's Scalar Mixer/Converter plus Phase (SMC+Phase) makes mixer and converter measurements simple to set up since reference and calibration mixers are not required. Calibration is easy to perform using three broadband standards: a power meter as a magnitude standard, a comb generator as a phase standard, and an S-parameter calibration kit (mechanical or ECal module).

PNA-X frequency converter applications provide:

- Simple setup using internal second signal source as a local oscillator (LO) signal
- Typical measurement time improvement of 100x compared to spectrum analyzer- based approach
- High measurement accuracy using two patented techniques:
 - Scalar Mixer/Converter (SMC) provides match and most accurate conversion loss/gain measurements by combining two-port and power-meter calibrations (S93082B), and with (S93083B), calibrated absolute group delay measurements without a reference or calibration mixer
 - Vector Mixer/Converter (VMC) provides measurements of match, conversion loss/ gain, delay, phase difference between multiple paths or devices, and phase shifts within a device, using a vector-calibrated through mixer (S93083B)
- Input and output mismatch correction reduces ripple and eliminates the need for attenuators
- Embedded-LO feature (S93084B) extends SMC and VMC measurements to converters with embedded LOs without access to internal time bases

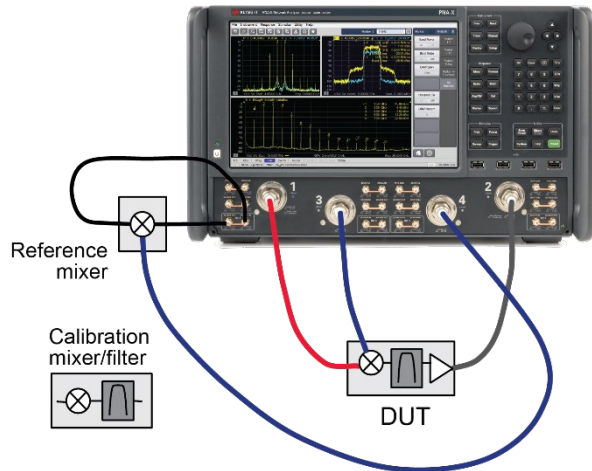

The Vector Mixer/Converter technique provides measurements of match, conversion loss/gain, delay, phase difference between multiple paths or devices, and phase shifts within a device

Calibration mixer/filter pair

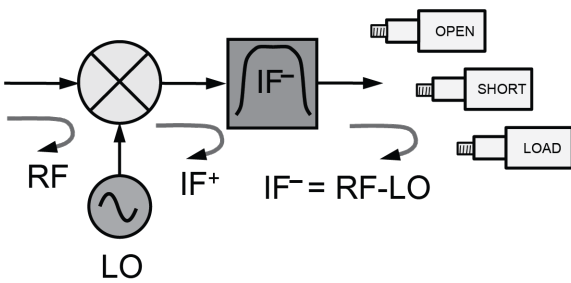

Keysight's patented Vector Mixer/Converter calibration method uses open, short, and load standards to create a characterized mixer through standard.

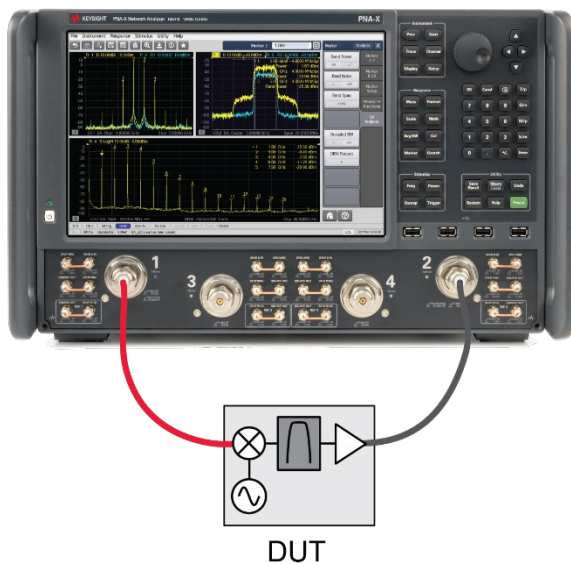

Both SMC and VMC can be used to measure converters with embedded LOs, without need for access to internal time bases.

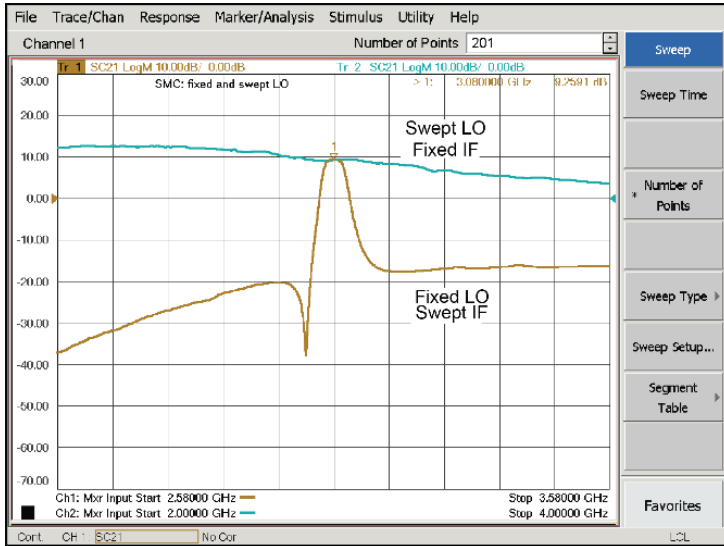

Figure 6. With two internal signal sources, the PNA-X provides fast measurements of both fixed and swept IF responses.

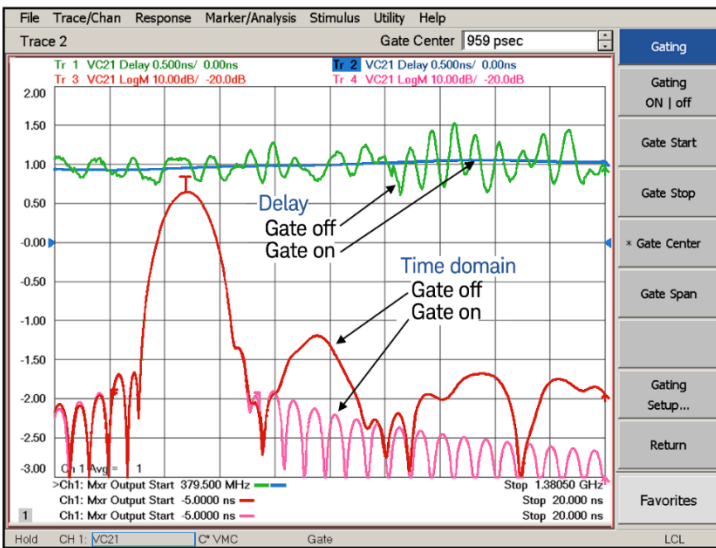

Figure 7. Time-domain gating can remove ripple by removing unwanted, time-delayed responses due to spurious signals.

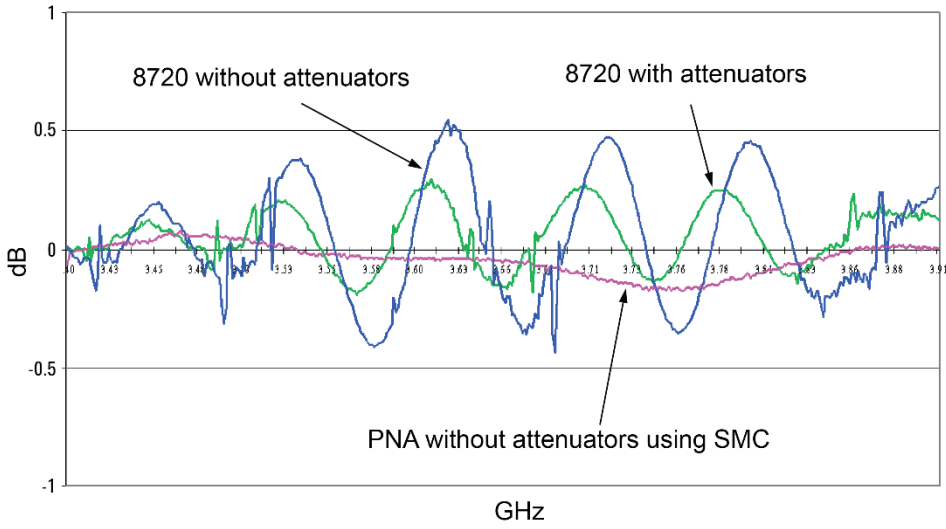

Figure 8. SMC's match correction greatly reduces mismatch errors in conversion loss/gain measurements, eliminating the need for attenuators at the ends of the test cables.

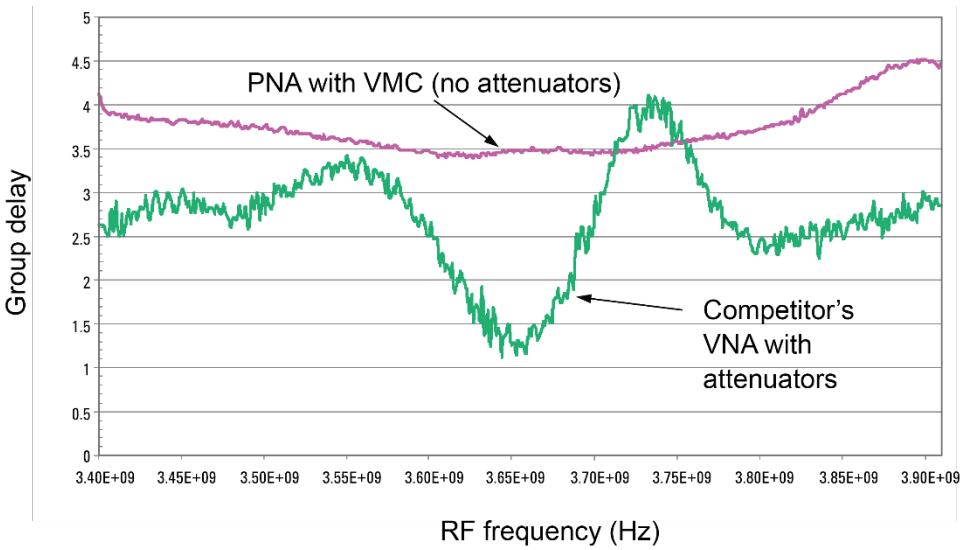
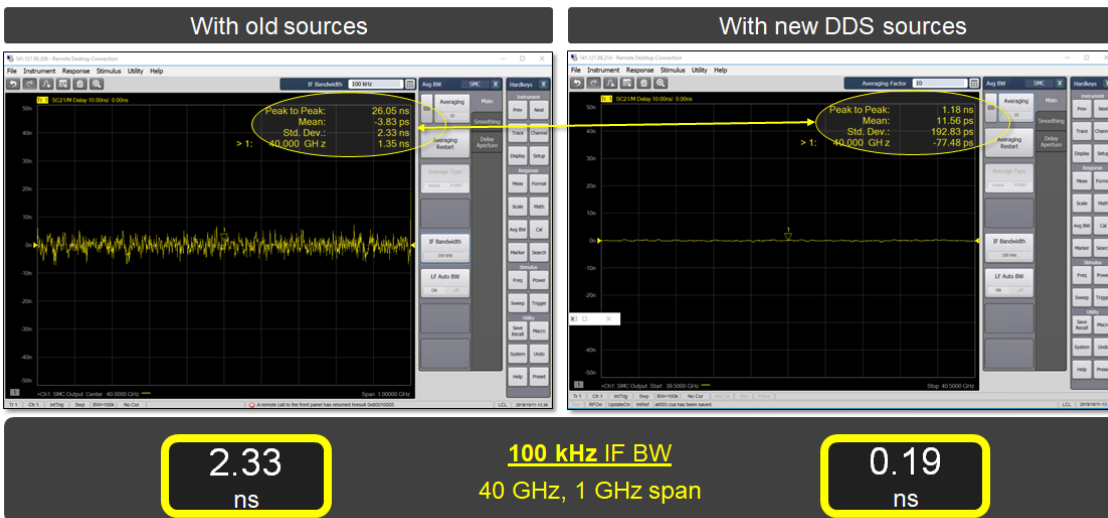

Figure 9. VMC's match correction greatly reduces mismatch errors in group delay measurements, eliminating the need for attenuators at the ends of the test cables.

Measurement speed improvement in SMC+Phase application

The frequency converter test is typically time-consuming, and you need to measure various measurement parameters such as gain, delay, phase, IMD, spurious, gain compression, and noise figure. One of the biggest benefits from the new DDS source is the phase measurement stability. When you measure the phase and delay of frequency converters, you may need to take averages due to relatively large trace noise of phase measurements, which slows down the measurements. The new sources achieve excellent phase measurement stability and eliminate the need for averaging. The combination of general speed improvement and excellent phase measurement stability significantly reduces the test time, and in some cases, it drastically improves the test throughput of the frequency converters by more than 50 times without compromising the measurement accuracy.



Mixer group delay measurement with SMC+phase application

Tips from the Experts

- Narrowing the IF bandwidth helps eliminate spikes on the measurement trace that result from LO feed through and other spurious signals from the DUT
- To prevent source-unleveled errors when measuring devices with high-level spurious outputs (such as unfiltered mixers), it is often helpful to increase the amount of source attenuation to provide better isolation between the DUT and the PNA-X
- When making VMC measurements on multistage converters, it is best to create a single “meta-LO” signal that can be used to drive the reference and calibration mixers
- When measuring unfiltered mixers, time-domain gating can be a useful tool to reduce ripple by removing undesired, time-delayed responses due to spurious signals

Innovative Applications

Phase noise measurement for component characterization (S930317B/321B)

Phase noise measurement application

Measurement challenges

- Phase noise or residual noise measurements require a spectrum analyzer or dedicated phase noise measurement instrument.
- Phase noise measurement setup for very high frequencies is complex

Phase noise measurement application provides

- The application simplifies your active device measurement configuration by using the same cable connection as other measurements (No need for spectrum analyzer)
- Phase noise, AM noise, residual noise and spurious measurements with offset frequency range of 0.1 Hz to 10 MHz
- The phase noise measurement noise floor comparable with high-performance signal analyzers with phase noise measurement capability like the UXA signal analyzer with phase noise measurement application.
- No harmonic mixers are required up to 125 GHz
- Low noise floor for residual noise measurements at close-in offset frequencies.

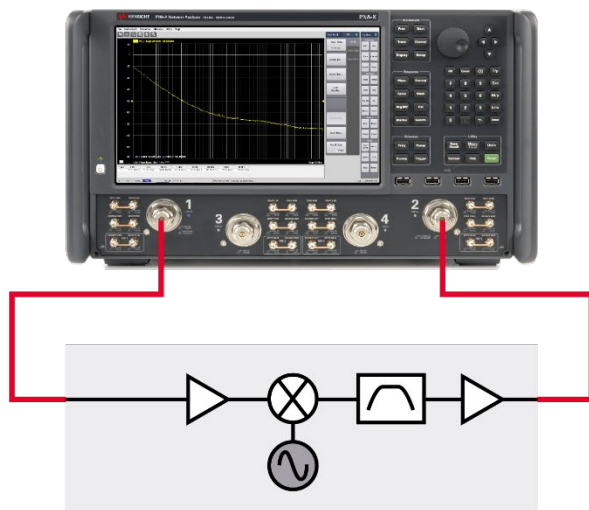

Embedded-LO frequency converter

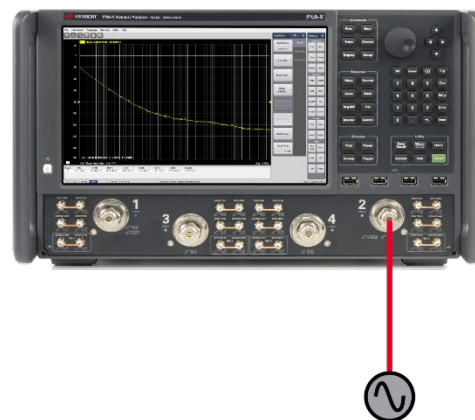

Signal source under test

Phase noise measurement setup examples

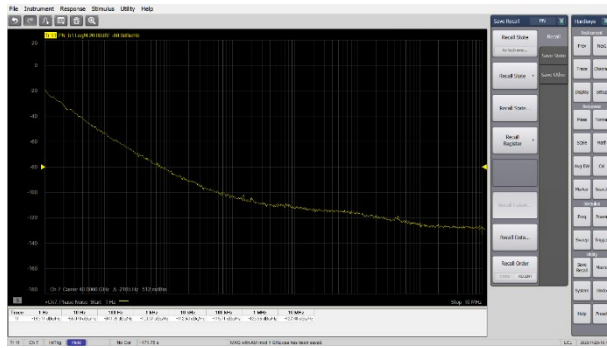

Figure 10. Phase noise measurement example

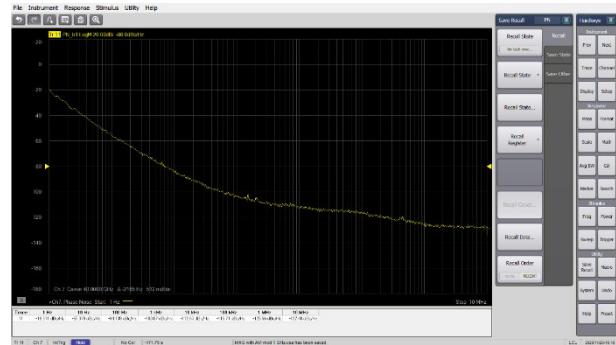

Figure 11. Oscillator phase noise, AM noise, and spurious measurement example

No need for harmonic mixers for millimeter-wave phase noise measurement

The measurement frequency range is from 10 MHz to the highest frequency of the PNA or PNA-X. When the N5292A test set controller and the N5293AXxx/5AXxx frequency extenders are connected to the PNA or PNA-X, (or the N5290A/91A broadband millimeter-wave test system is used), the phase noise can be measured up to 110 GHz/125 GHz. Unlike the dedicated phase noise test systems, no harmonic mixers are needed even for millimeter-wave frequencies.

Measurement performance

- Offset frequency range: 0.1 Hz to 10 MHz
- Sweep speed (typical): 34 seconds (1 Hz to 10 MHz offset in normal mode)

Sensitivity (supplemental performance data)¹

SSB Phase noise sensitivity [dBc/Hz] (supplemental performance data)²

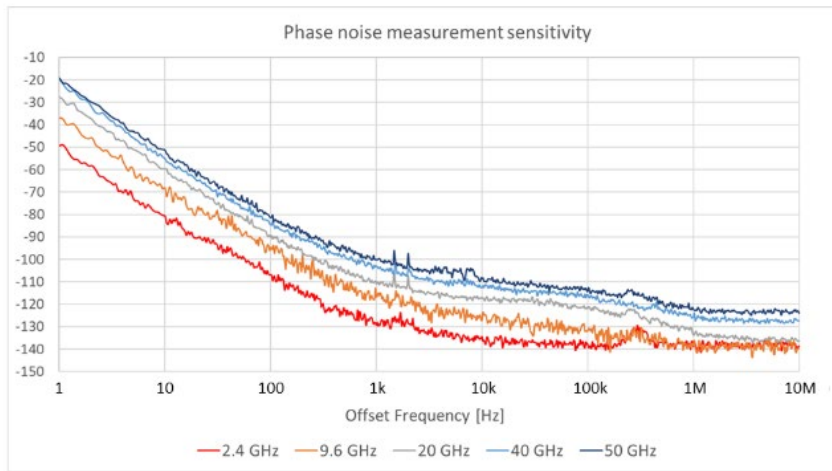

Figure 12. PNA Phase noise measurement noise floor

SSB residual noise sensitivity [dBc/Hz] (supplemental performance data)²

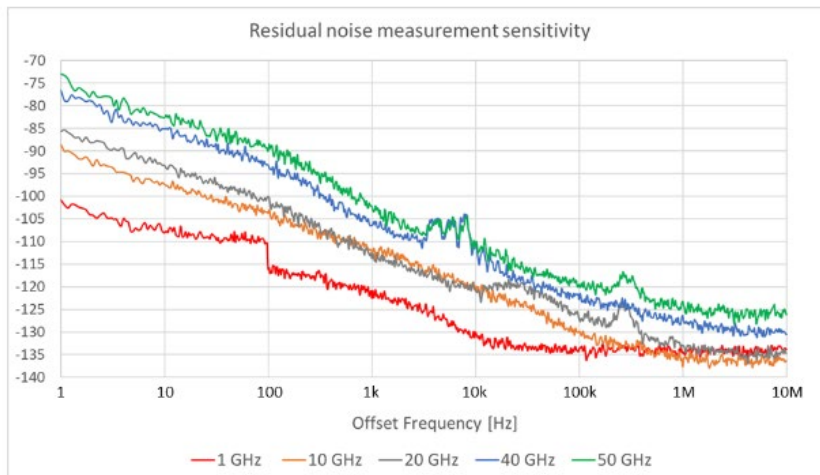

Figure 13. PNA residual noise measurement noise floor

1. Supplemental performance data (SPD) represents the value of a parameter that is most likely to occur; the expected mean or average.
2. N5245B PNA-X sensitivity at 300 kHz offset may be worse than that at 100 kHz offset by a few dB for certain carrier frequencies.

Innovative Applications

Fast multi-channel spectrum analyzer for component characterization (S93090x/093/094B)

Spectrum analysis challenges for component testing

- Measuring spurious performance is time consuming, especially when searching for low-level spurs over a broad frequency range
- Long measurement times may force insufficient test coverage
- Characterizing spurs over operating range of the DUT is tedious to accomplish or requires external control software

PNA-X spectrum analyzer (SA) application provides:

- Fast spurious searches over broad frequency ranges
- A multi-channel SA with internal swept-signal generators for efficient spurious analysis of mixers and converters
- In-fixture spectrum measurements using VNA calibration and de-embedding techniques
- Fast band- and noise-power measurements
- SA capability to the PNA-X's single-connection, multiple-measurement suite

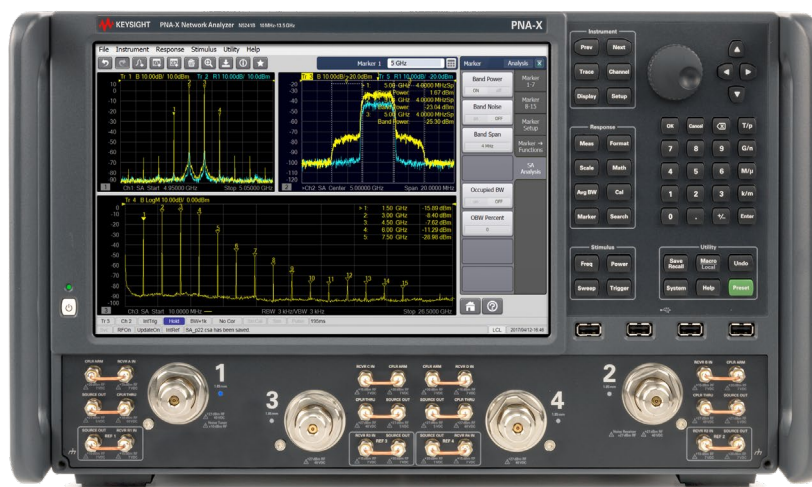

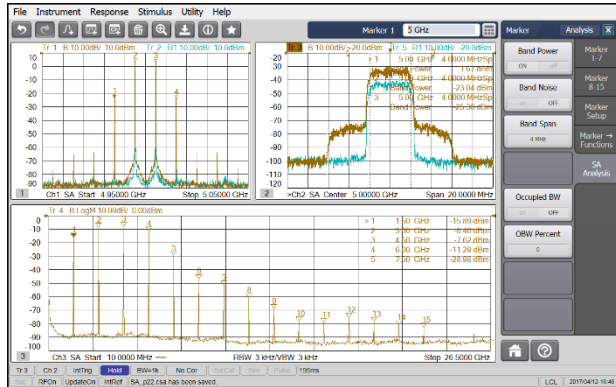

Spectrum analyzer option adds fast spur search capability to the PNA-X, replacing a standalone spectrum analyzer and switch matrix in component-characterization test systems.

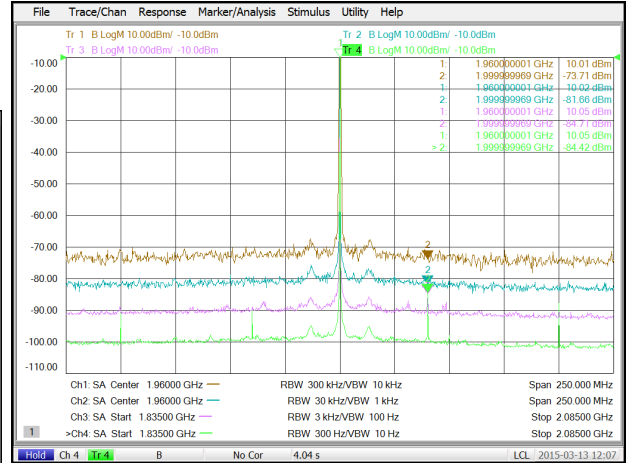

Above plot shows -84 dBm spurious measurements in the presence of a +10 dBm signal, with (from top to bottom) approximate S/N (at RBW) of 80 dB (300 kHz), 90 dB (30 kHz), 100 dB (3 kHz), and 110 dB (300 Hz).

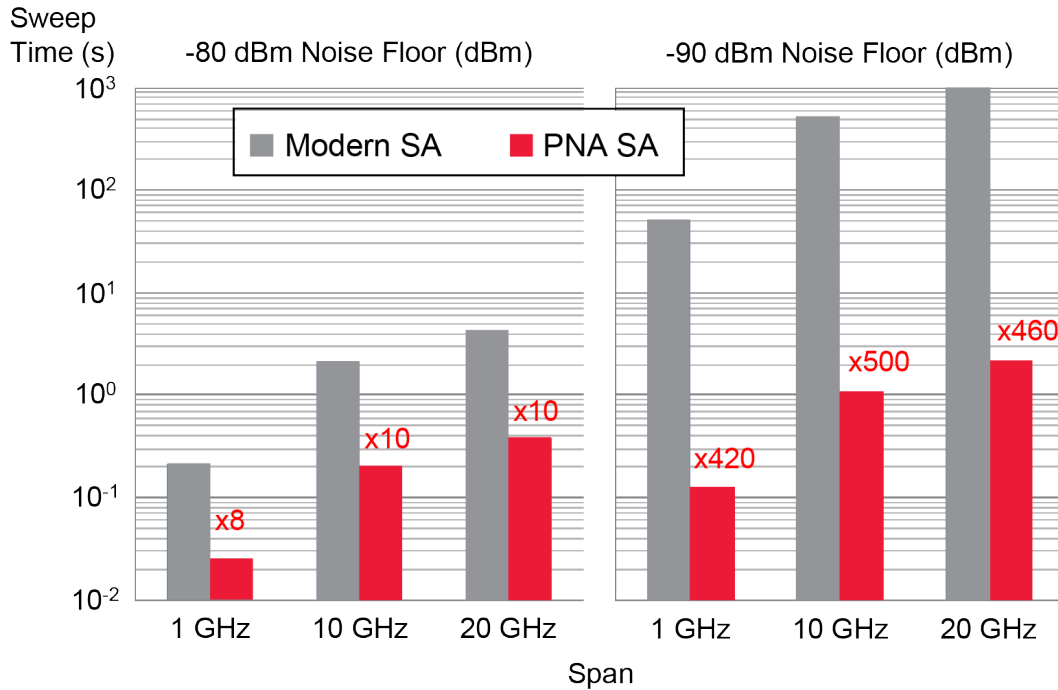

Sweep time versus span with 12 GHz center frequency for -80 dBm and -90 dBm noise floor. The receiver attenuator is set to avoid compression with a +10 dBm signal.

Providing multi-channel spectrum analysis

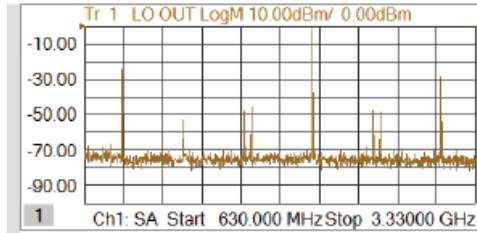
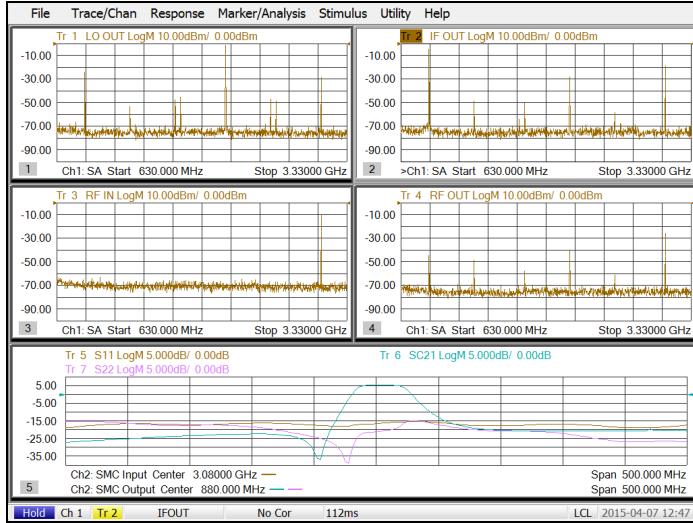

Output spectrum on LO port

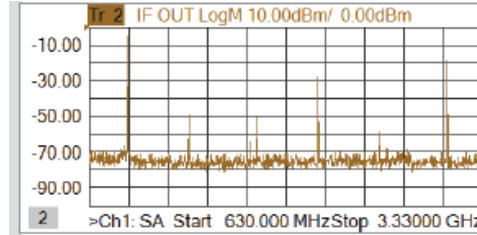

Output spectrum on IF port

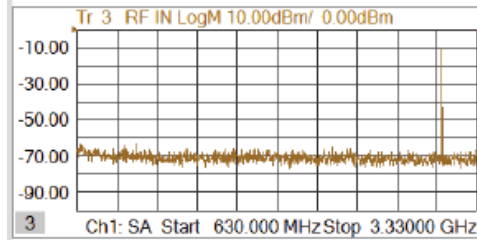

Input spectrum on RF port

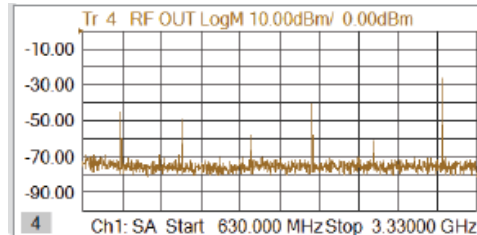

Output spectrum on RF port

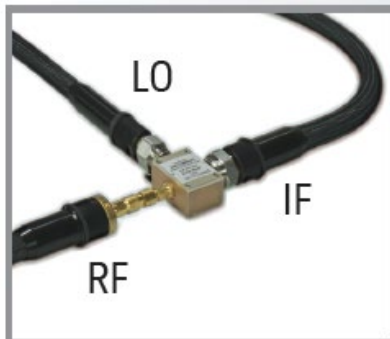

Having spectrum analyzers on all ports of a mixer or converter provides unparalleled insight into the performance of the device. With a single set of connections, the spurious content emanating from all ports is readily apparent during operation with fixed or swept stimuli. Measured spurs can include LO, RF, and IF feedthrough, harmonics, intermodulation products, and other higher-order mixing products. Conversion loss and match versus frequency is easily seen in a companion SMC channel (bottom right graph).



Tips from the Experts

- Choose different levels of software-image rejection to trade-off measurement speed with thoroughness, based on the spectral density of the measurement
- For harmonics measurements, add a separate SA channel for each harmonic with a narrow frequency span and RBW to optimize speed and sensitivity, and with enough receiver attenuation to avoid internally generated harmonics
- To help identify spurious signals that might be interfering with a measurement, use the Marker-to-SA feature to easily create a spectrum display with the same stimulus conditions at the marker position in SMC, swept-IMD, or standard channels
- When using de-embedding to measure in-fixture or on-wafer devices, use the power-compensation feature to overcome the loss of the fixture or probes, thereby delivering a known stimulus power to the DUT

Unlock true performance with VNA calibration

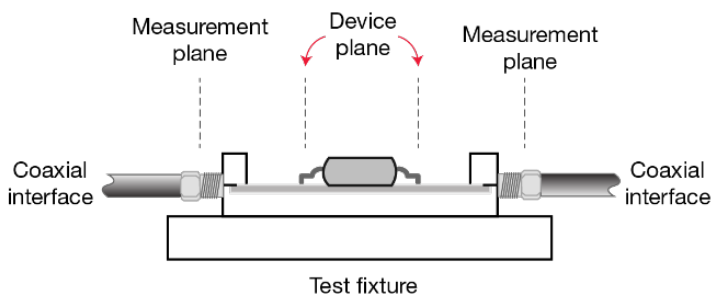
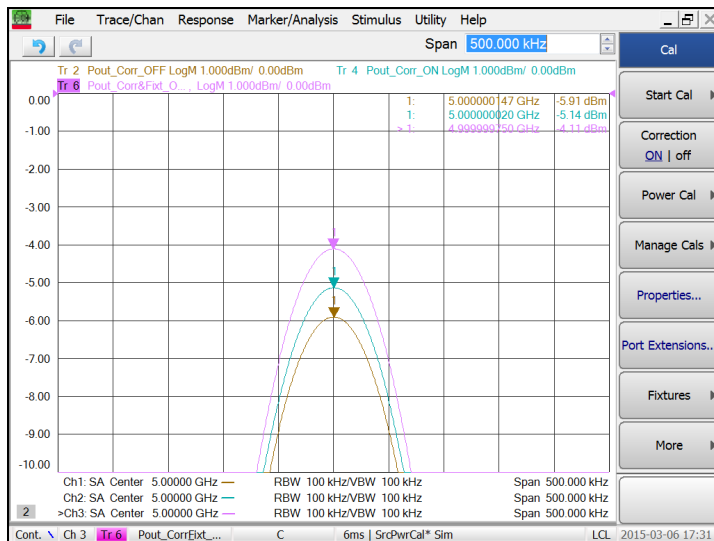

VNA calibration and fixture de-embedding remove cable and fixture effects and correct receiver response errors, providing calibrated in-fixture spectrum analysis.

Innovative Applications

New capability of spectrum analysis application - Noise Power Ratio (NPR) measurements (S93090x/093/094B)

Challenges for amplifier noise power ratio (NPR) measurements

- It requires a spectrum analyzer for the analysis, and the measurement takes a long time due to the need for lots of averaging of random, noise-based signals
- It's difficult and time-consuming to correct the flatness of the multi-tone input stimulus
- The distortion floor in the notch may not be low enough, especially if a booster amplifier is used

The spectrum analysis application provides:

- Achieve fast and accurate NPR measurements with vector averaging of coherent, repetitive, multi-tone test waveforms
- Control external signal generators and AWGs to easily generate wideband modulated signals
- Quickly correct the power flatness of input signal
- Lower the distortion floor in the notches and adjacent channels with distortion- cancelling tones
- NPR measurement can be done as part of a single-connection-multiple- measurement setup with no cable changes

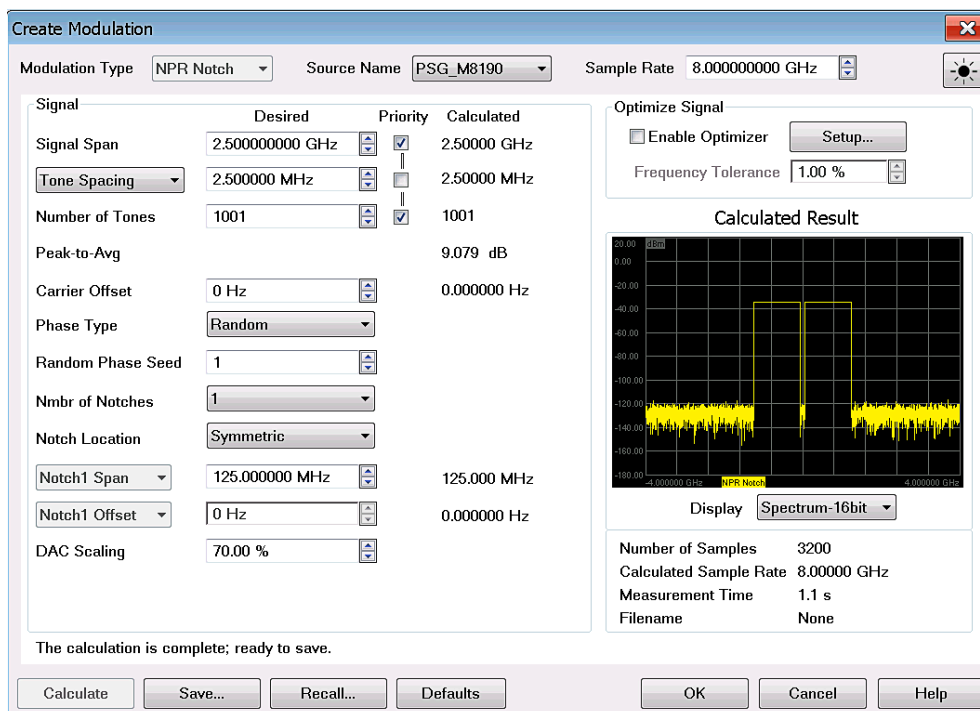

External signal generator wideband modulation signal creation on the PNA-X

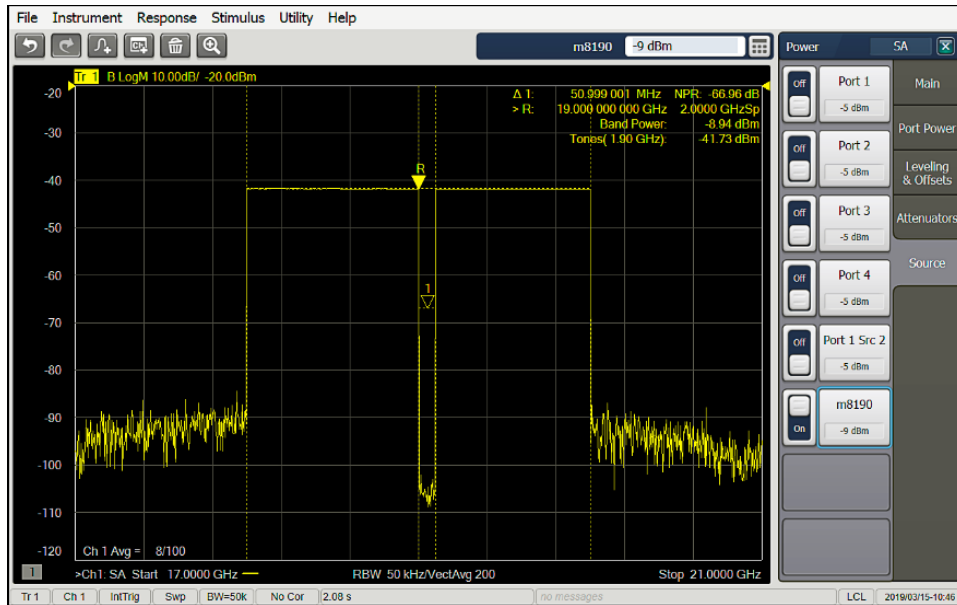

Figure 15. Improved flatness and lower noise floor in the notch after signal correction

Tips from the Experts

- NPR is sometimes used to estimate the EVM of an amplifier, without the need for full demodulation
- NPR can also be used to evaluate high-linearity devices such as Analog-to-Digital Converters (ADC) by providing a test signal with a dense spectrum, and a clear notch from which the ADC distortion can be seen
- The new NPR signal calibration can support correcting the signal at the output of an amplifier for power and flatness, while correcting the signal at the input for low-notch distortion. This is a great way to support NPR measurements for exact power at the output while maintaining a pure signal at the input of an amplifier-under-test

Innovative Applications

EVM, NPR and ACPR measurements for component characterization modulation distortion (S93070xB)

Measurement challenges

- For increasingly complex modulation schemes with wide bandwidths (BW), EVM measurements become more difficult as the EVM of the DUT gets closer to the “residual EVM”, the EVM of the test system. The imperfectness of the generated signal and the wideband noise captured by the receivers cause residual EVM, leading to SNR degradation as the BW increases.
- The frequency response as bandwidth increases, test fixtures (cables, attenuators, booster amplifiers, etc.), loss, and mismatch cause inaccuracies in modulated performance measurements. Furthermore, the actual signal applied to the DUT differs from the ideal signal.
- When creating models for digital pre-distortion (DPD), it is impossible to separate the non-idealities of the test system and those of the DUT.
- EVM measurements require increasingly wide modulation analysis bandwidths, ex. 5G FR2 and 6G exploration, leading to

Our application for modulation distortion analysis provides:

- VNA calibration and de-embedding applied to modulation analysis for accurate modulated measurements up to sub-THz frequencies.
- Isolation from the distortion and additive noise contributions from the DUT while removing error contributions from the input signal and the test system.
- Very wide measurement analysis bandwidth (limited only by the signal generator).
- High dynamic range, fast measurement speed, and the lowest residual EVM.
- Simplification of high-power setups and switch matrices for EVM, NPR, and ACPR measurement.
- Accurate and repeatable model extraction and linearization assessment (e.g., DPD complexity) of active devices.

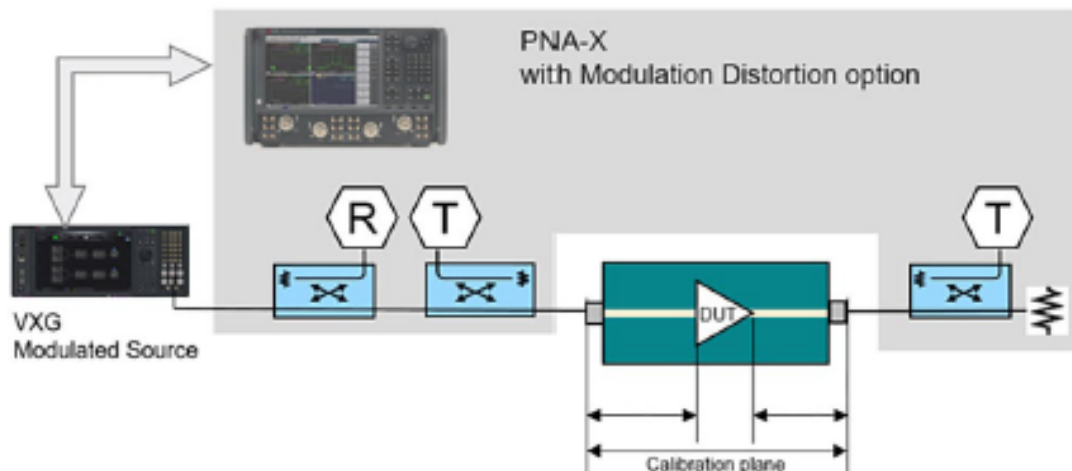

A Vector Signal Generator is used to generate a repetitive signal with a given CCDF (Complementary-Cumulative-Distribution-Function) and PSD (Power Spectral Density)-Compact test signal generation. The VNA then measures the amplitude of the input spectrum $|X(f)|$, the amplitude of the output spectrum $|Y(f)|$, and the phase relationship of the tones relative to each other, $\phi(Y(f))-\phi(X(f))$.

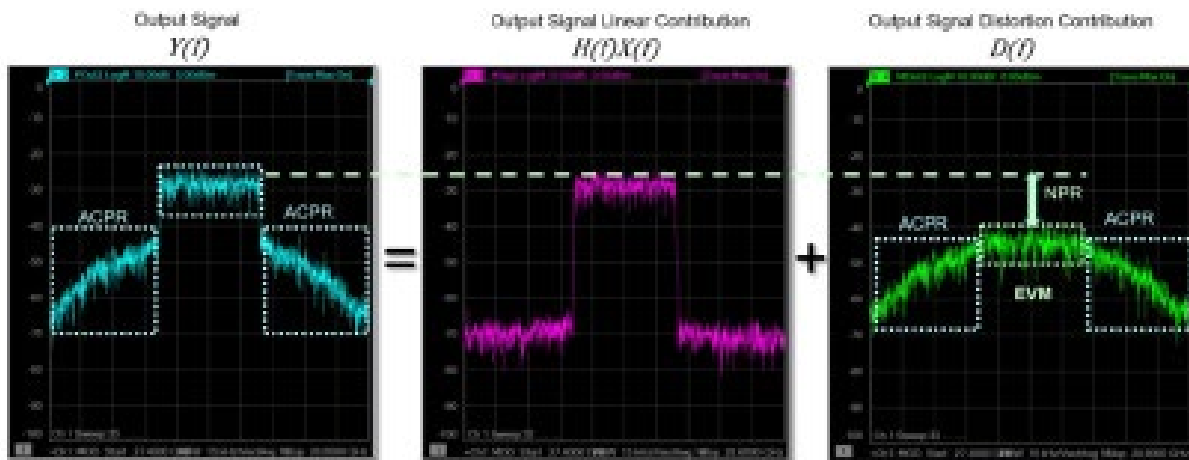
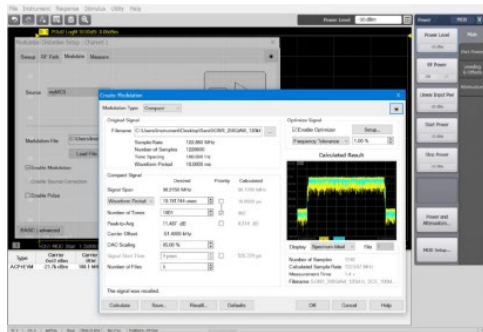

Calculation of the spectral correlation between the input and output enables decomposition the output spectrum into linearly correlated and non-linear spectrum and analysis of the distortion product EVM, ACPR and NPR

- The spectral correlation enables to determination of the linear and nonlinear distortion solely introduced by the DUT, eliminating contributions from the signal generator.
- Repetitive test signals are designed to faithfully represent the amplitude statistics as well as the power spectral density of the modulation format of choice.
- The total amount of distortion measured in the frequency domain is equal to the total amount of distortion in the time domain as measured using the existing EVM method.
- To increase measurement speed, a Compact Test Signal (CTS) can be used. CTS generation is fully automated, with input waveforms formatted as either Signal Studio or *.csv IQ files. The resultant CTS version of the waveform matches the CCDF and PSD of the “parent-IQ waveform”. The CTS waveform makes measurements faster while maintaining proper spectral and power statistics.

After characterizing the DUT's performance under modulated signal, the next step is to see how the distortion can be minimized using digital predistortion (DPD).

Measurement Challenges

- Linearization of the device typically requires a receiver BW that is 5 times the signal bandwidth. Using spectral stitching, the VNA can maintain very high dynamic range while making very wideband measurements.
- When performing DPD using a traditional method using a vector source and signal analyzer, it is impossible to separate the impairments of the test system and those of the DUT.
- This issue is further compounded for high power DUTs, where booster amplifiers and couplers and attenuators are needed for the measurement.

The new DPD feature in Modulation Distortion provides:

- Calibrated, repeatable DPD that separates the impairments of the test system from those of the DUT.
- Direct DPD to see what the optimal achievable EVM and ACPR are for the DUT.
- Memory Polynomial DPD to see how well the DUT can be linearized as a function of the DPD complexity.

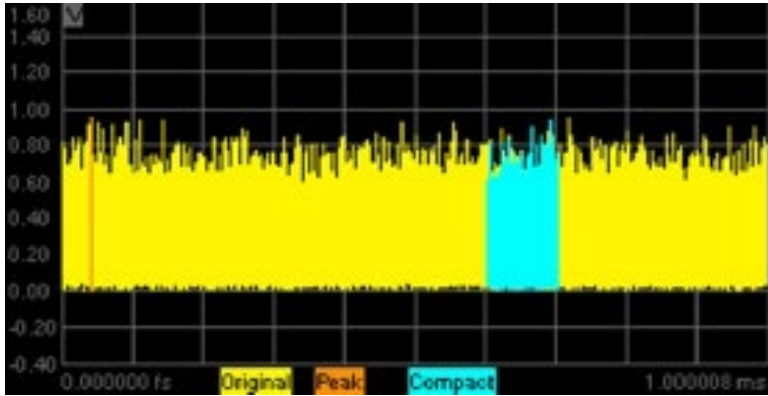

Figure 16. Example of a 5G NR 100 MHz parent-IQ waveform and Compact Tetra Signal (CTS) time slice

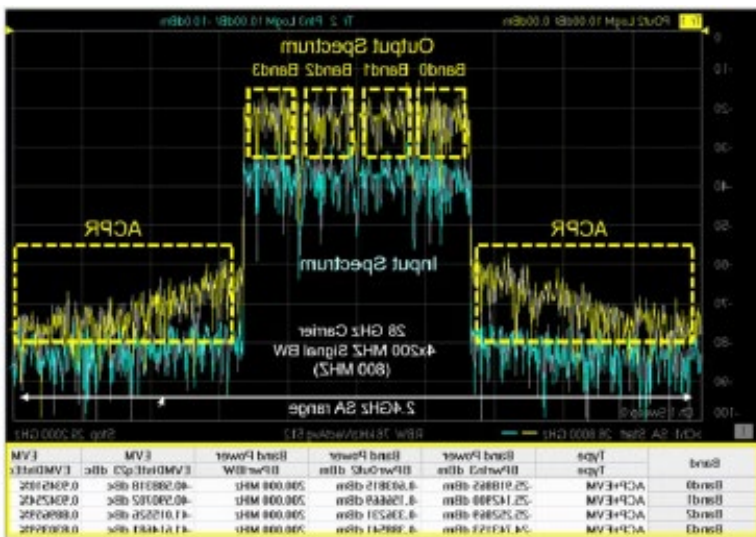

Figure 17. Measurements on a 200 MHz x 4CC (800 MHz) at carrier frequency of 28 GHz

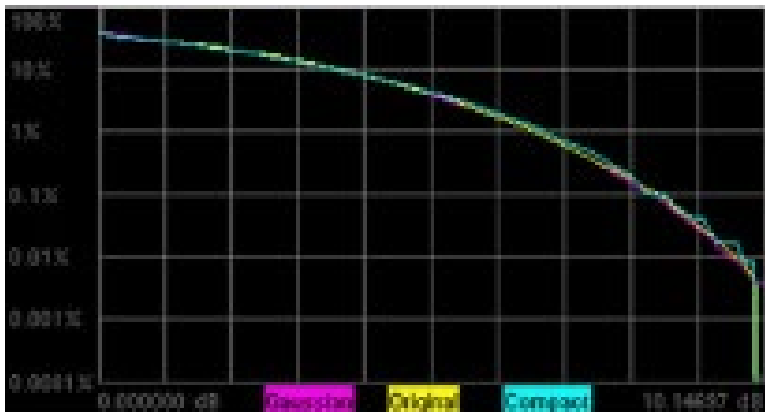

Figure 18. CCDF Comparison of the original 5G NR 100 MHz signal vs. compact test signal consisting of 10,001 tones. Share the same Power Spectral Density (PSD) and Complementary Cumulative Density Function (CCDF).

The combination of S93070xB and S93083B allows you to measure EVM/NPR/ACPR of mixers or frequency converters under wideband modulated stimulus condition without losing any advantages of this application: very low residual EVM and NPR, intuitive operation with simple setup, no bandwidth restriction, and accurate and consistent reproducibility. (S93084B is also required for embedded-LO frequency converter.)

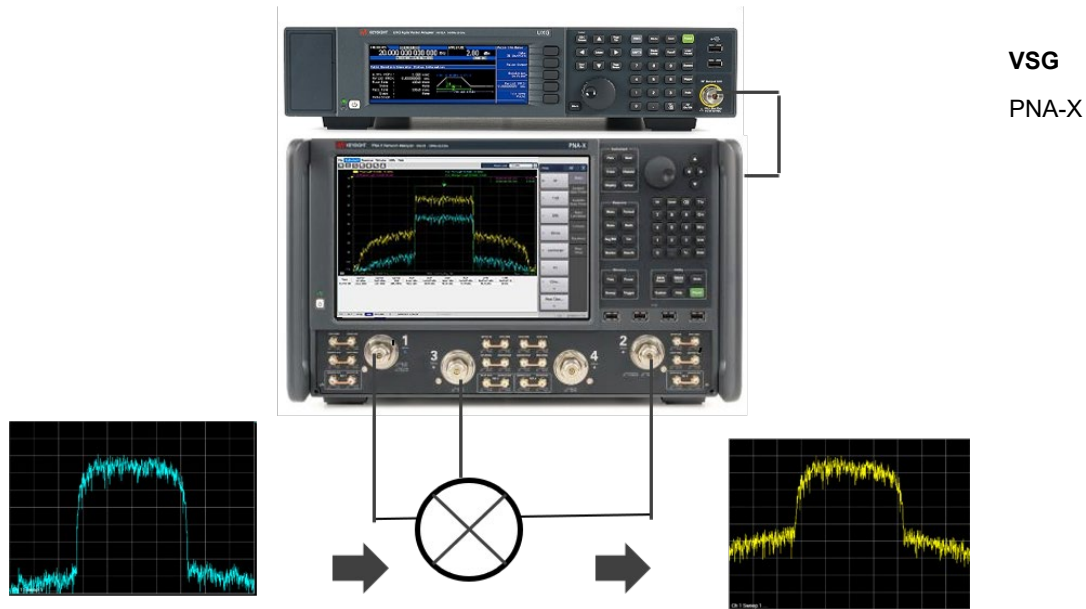

Figure 19. Mixer EVM/NPR/ACPR measurement with Modulation distortion application

Tips from the Experts

- S-parameter, IP3, power compression, NF, as well as modulation distortion. You can change the measurements anytime to fully characterize your DUT.
- Use modulation source correction feature to correct your signal to be desired waveform at the reference plane, and you will achieve the best accuracy and reproducibility of your measurement with modulated stimulus condition
- It is always better to make a measurement within a short time. Measurement time can be determined by a few parameters like SA Span, noise bandwidth, and number of tones. Measurement throughput and measurement accuracy are generally a trade-off. It is important to have a good balance of speed and accuracy and adjust the parameters depending on the target measurement value.
- For more information about the modulation distortion application, refer to Technical Overview, S93070xB Modulation Distortion Application for the PNA-X, [5992-3974EN](#).

Innovative Applications

Internal 6 GHz arbitrary waveform generation application – (S93072B)

Challenges for active device distortion measurements

- Active device behavior depends on its input signal's characteristics.
- Accurate active device characterization requires a complex setup that includes a vector signal generator or arbitrary waveform generator.

Internal 6 GHz arbitrary waveform generation application provides:

- A Direct Digital Synthesizer (DDS) to generate modulated signals including multitone, complex digital modulation signals up to 6 GHz to make EVM, NPR, and ACPR measurements with either S93070xB Modulation Distortion application or S93090xB Spectrum Analysis application.
- Simpler setup for active device characterization under modulated signal conditions

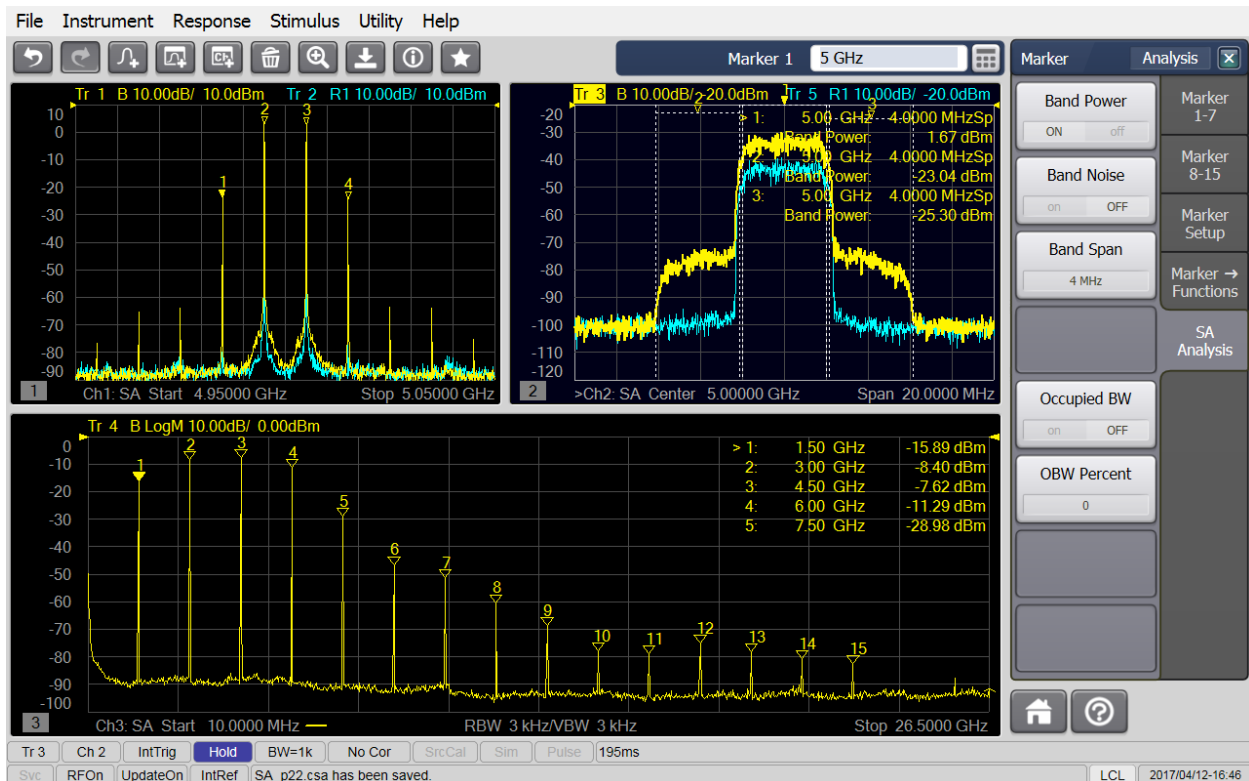

Tips from the Experts

Modulated signals can be generated within the frequency range, 10 MHz to 3.3 GHz or 3.2 GHz to 6 GHz for Ports 1 and 3, 10 MHz to 6 GHz for Ports 2 and 4 and XSB Port. The sample rate is 19.2 GHz/N. The minimum tone spacing range is 150 kHz. The tones must be on a frequency grid of $(M/N) * 600$ MHz.

Keysight's IQTools software helps you to generate the modulated signal easily.

Innovative Applications

VSA wideband IQ data link application – (S93050B/51B/52B)

Challenges for active device distortion measurements

- Modulation distortion analysis often requires vector signal generator, spectrum analyzer and the industry- standard Pathwave Vector Signal Analysis (89600 VSA).
- Until recently, wideband receivers were needed to capture active device output signals, limiting the accuracy of EVM measurements.

VSA wideband IQ data link application provides:

- Single-connection multiple measurements of active device distortion analysis utilizing the 89600 VSA application software running on PNA for transmitter test for 5G applications.
- The ability of sending IQ data from the PNA to the VSA SW and analyze demodulation EVM, AM-AM/AM-PM, etc. with the VSA SW.
- The Maximum IQ data bandwidth is up to 1.5/4/10 GHz (S93050B/51B/52B) (The SW license is not needed for the bandwidth <200 MHz.)
- More accurate measurements with VNA calibration engine
- Good data correlation with X-series analyzers
- MIMO measurements up to 5 channels

VNA firmware

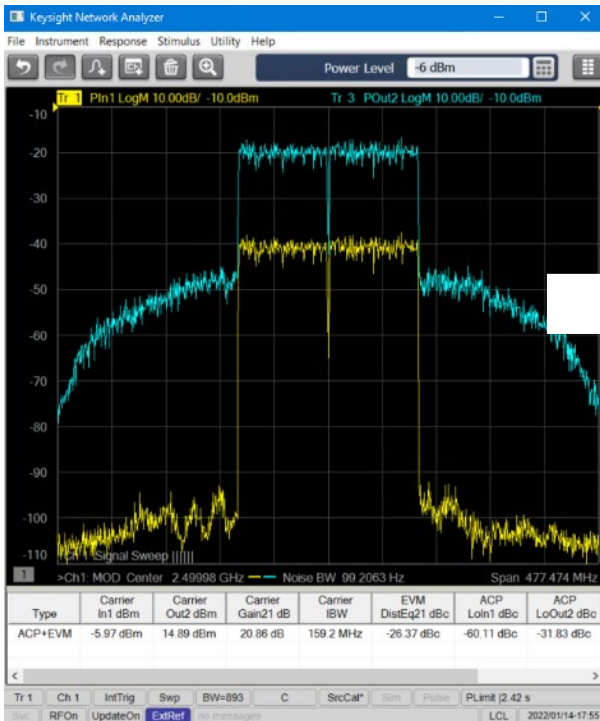

VSA running on PNA-X

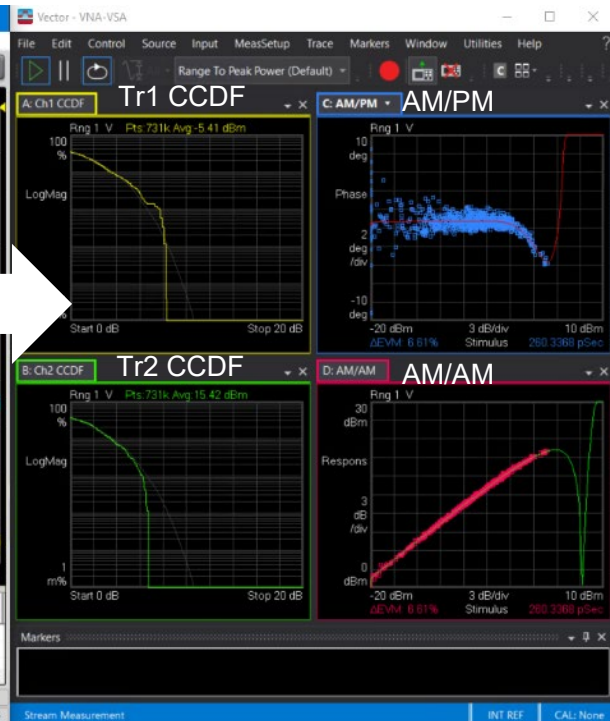

Tips from the Experts

Easily port your VSA setups from any X-Series analyzer seamlessly to the PNA platform. Easily analyze a broad range of signals including 5G, Wireless LAN, radar and more up to 4 GHz of analysis Bandwidth and 6G up to 10 GHz with a millimeter-wave VNA configuration. Access to multiple receivers in the PNA allow for 5 simultaneous measurements, making it ideal for MIMO applications.

5 simultaneous measurements, making it ideal for MIMO applications.

Digital Wideband Transceiver Analysis (S94610B)

Enables cross-domain stimulus response measurements for digital/RF mixed-signal device characterization as an S94610B Device Measurement eXpert (DMX) add-on software application. Included Waveform Creator helps define digital IQ test stimulus waveforms that are used in the RF signal generators for receiver tests or downloaded to the digital-to-analog converters for transmitter tests. The DUT control is customizable to accommodate various data converters and transceiver types by defining device operation settings, transmit/receive switching, reading, and writing digital IQ waveform from and to DUTs. Acquired RF or digital data is processed in the VNA's applications for faster, accurate measurements and analysis. The Digital Wideband Transceiver Analysis requires S9307xB Modulation Distortion for frequency response measurements, and S9309xB Spectrum Analysis for receiver noise figure and two-tone IMD measurements.

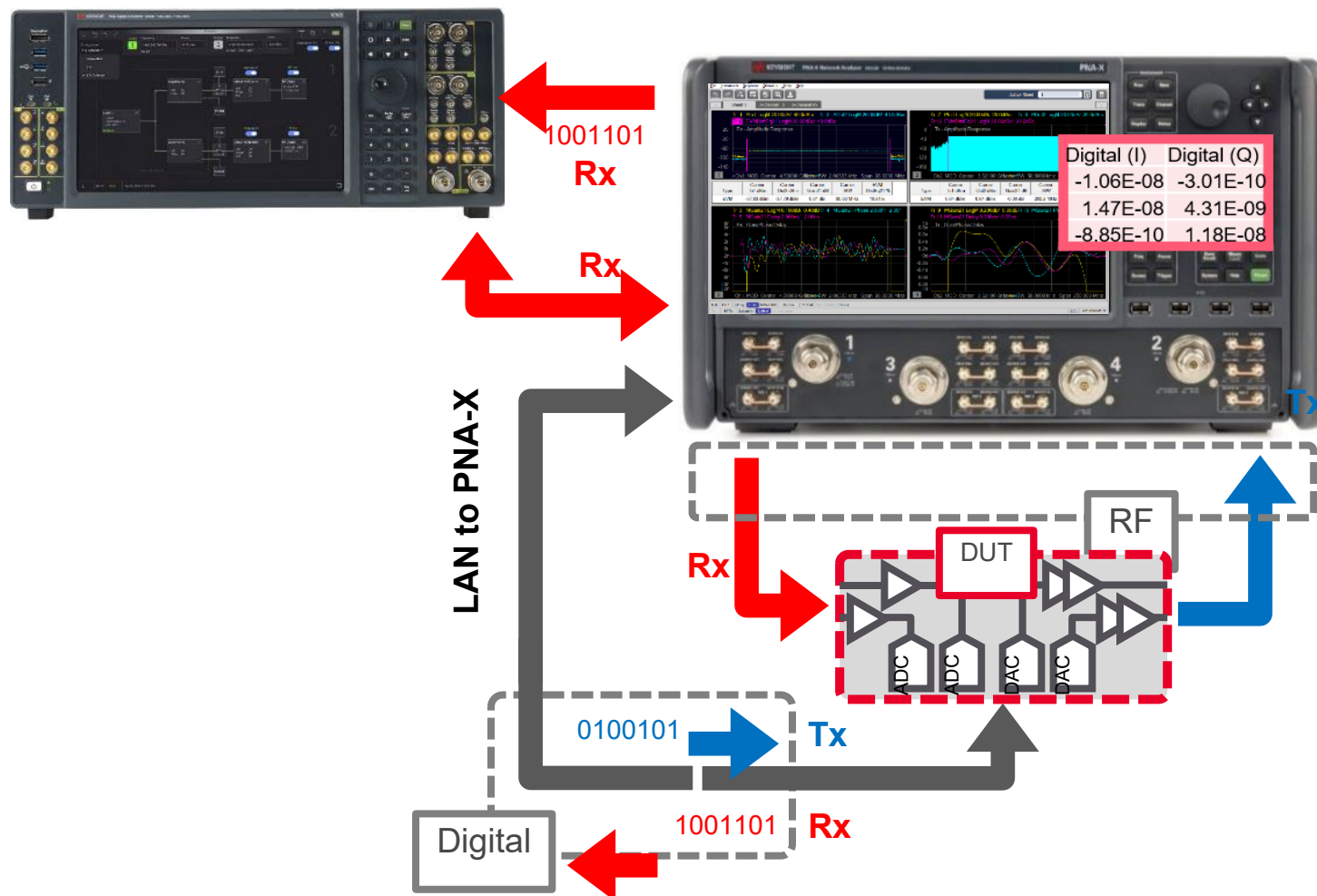

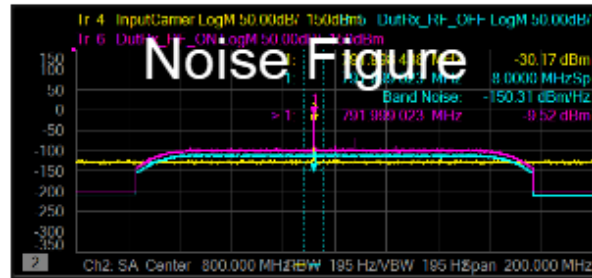
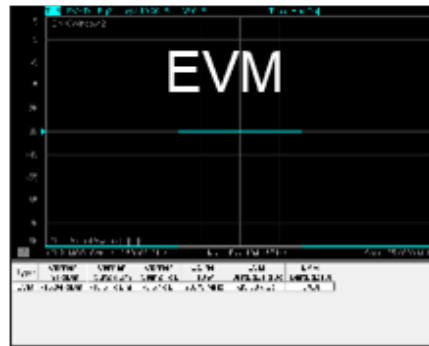
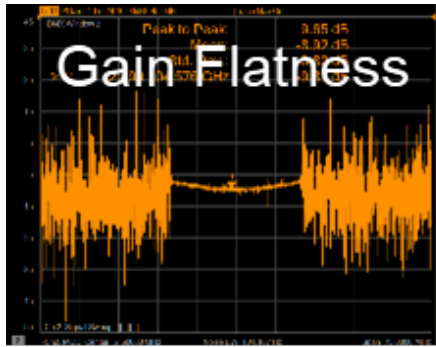

Innovative Applications

Load Pull Capability for Modulation Distortion Measurements (S94570B/71B)

Non-50 Ω load distortion measurement challenges

Power amplifiers operating at wide bandwidths need good power efficiency and linearity, but performance can vary drastically with non-50 Ω load conditions.

The sensitivity of nonlinear distortion parameters to load conditions is important in R&D and DVT since nonlinear effects are difficult to correct.

PNA-X's arbitrary load control application provides:

Provides integrated load-pull solution for computing vector corrected EVM and ACPR measurements for user specified load conditions under modulated input stimulus

Provides simple interface with guided tuner setup and characterization for user specified gamma at the reference plane

Includes benefits of modulation distortion application, including wide dynamic range and lower residual EVM



User specified load grid values displayed with measured values at each load point, verifying the accuracy of gamma values at the device reference plane

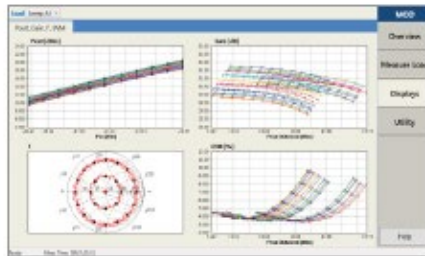

Easily view gamma over measured frequency range and plot measurement results as a function of varying load conditions

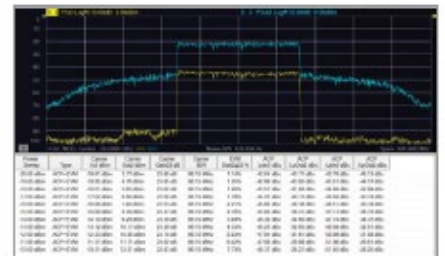

Power sweep measurements provide insight into sensitivity and performance changes under varying load conditions

Innovative Applications

Wideband Active Load Pull Capability for Modulation Distortion Measurements (S94572B/573B)

Distortion measurement challenges

- Performance of power amplifiers under modulated input conditions can vary greatly if the load condition presented during the measurement is different than the load condition presented to the DUT under normal operation

PNA'Xs wideband active load control application provides:

- Provides integrated active load pull solution for computing vector corrected EVM and ACPR measurements for user specified gamma load profiles
- Provides control and measurement gamma at all frequencies in modulation bandwidth using active modulated source, is differentiated from passive load pull where gamma is controlled only at the center frequency and uncontrolled at other frequencies across the modulation bandwidth
- Includes benefits of modulation distortion application, including wide dynamic range and lower residual EVM

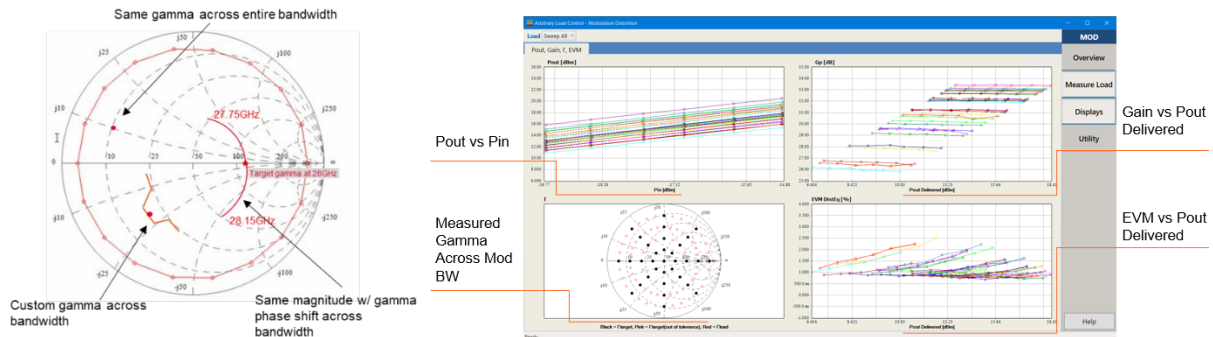

Innovative Applications

Control relative magnitude and phase between two sources for active output-load control (S93088B)

Amplifier load-pull measurement challenges

- Amplifier gain, output power, and power efficiency are commonly measured under different output-load conditions to determine the optimum large-signal match
- Traditional approach uses mechanical tuners which can handle high power, but are slow and cannot supply highly reflective loads

PNA-X with source-phase control provides:

- Control of second source to electronically tune reflection coefficient at output of amplifier
- Fast tuning speed and full reflection
- Match correction for accurate amplitude and phase control
- Measurements of amplifier output power, match, gain, and PAE under different load conditions

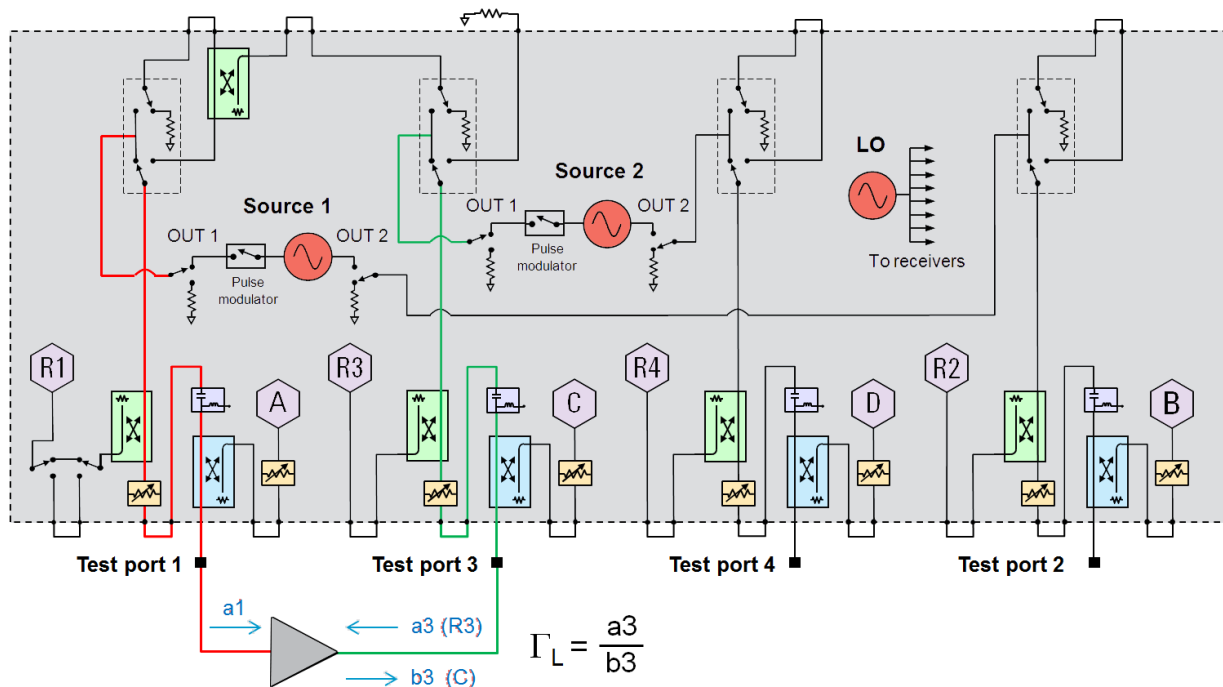

Generate arbitrary output-load impedances by controlling the magnitude and phase of the signal coming out of port 3 while the DUT is driven from port 1.

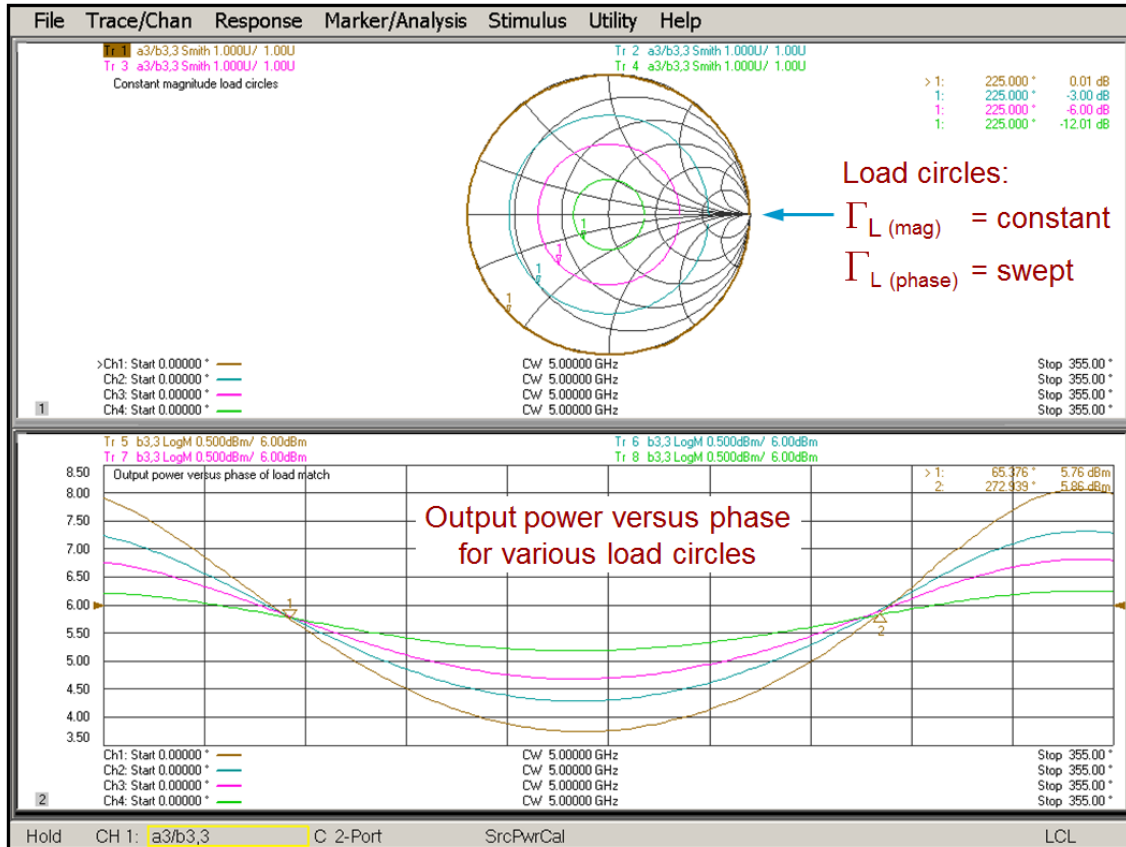

Example of load circles generated by keeping the magnitude of r_L constant while sweeping phase

Tips from the Experts

- Measurement setups can use receiver (R3, C...) or wave (a3, b3...) terminology
- Use the equation editor to calculate the power delivered to the load (forward power - reverse power) as $\sqrt{\text{pow}(\text{mag}(b3_3),2) - \text{pow}(\text{mag}(a3_3),2)}$
- Use mechanical tuners and external software for hybrid load-pull systems that can handle high output power and achieve full reflection
- When using external signal sources, connect instruments to a common 10 MHz frequency reference

Innovative Applications

Simplified test of I/Q converters and modulators, and differential mixers (S93089B)

I/Q and differential converter measurement challenges

- Requires signals with 90° or 180° phase difference
- Traditional approach uses hybrid couplers and/or baluns which are:
 - Inherently band-limited, requiring multiple components for broadband measurements
 - Limited to fixed phase offsets, preventing phase sweeps to determine optimum alignment
 - Lossy and inaccurate ($\pm 3^\circ$ to 12° typically)
 - Difficult to use with on-wafer setups

PNA-X differential and I/Q devices application

- Provides accurate phase control of internal and external sources, eliminating the need for hybrid couplers and baluns
- Tunes receivers to all user-specified output frequencies needed to fully characterize the DUT
- Sweeps frequency to measure operating bandwidth or sweeps phase and power at a fixed frequency to measure quadrature or differential imbalance
- Includes match-corrected power measurements for highest accuracy

The I/Q inputs of this modulator can be directly driven with the internal sources of the PNA-X, eliminating the need for a 90° hybrid coupler

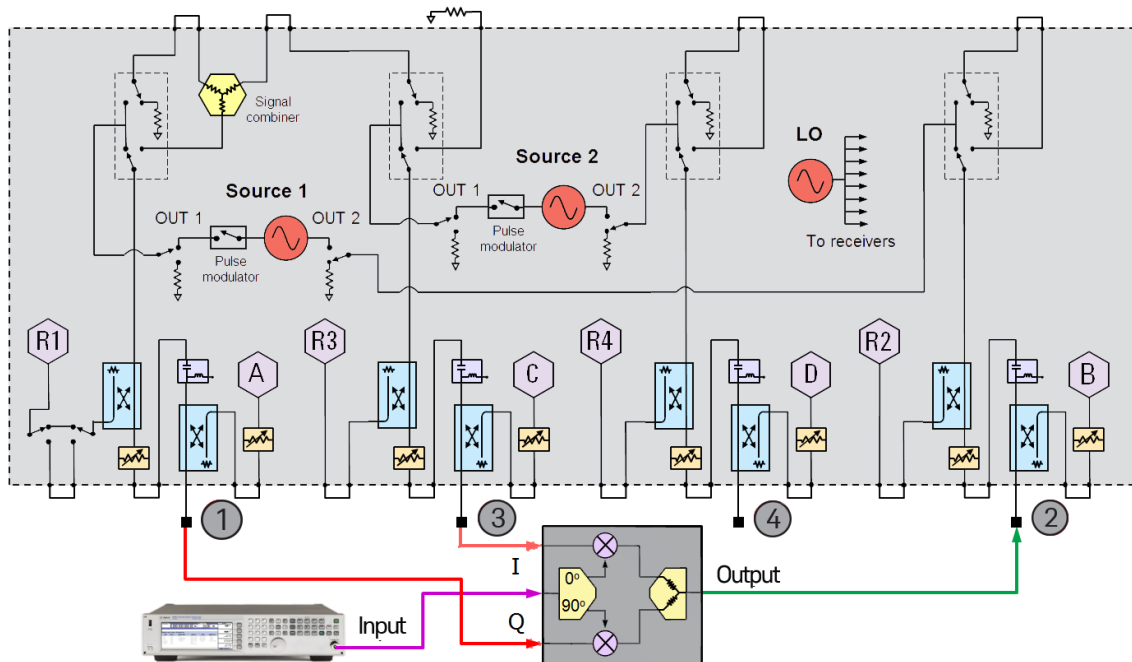

Tips from the Experts

- Two additional external sources can be used to create differential I/Q drive signals. The external sources must be routed through the PNA-X test set to measurement receivers in order to achieve the desired phase offsets
- For I/Q modulators, DC power supplies or source- measurement units (SMUs) can be routed through the bias tees to the I/Q inputs of the DUT. Voltage sweeps can then be performed to help find the optimum I/Q- voltage offsets for the greatest amount of LO suppression
- Measure harmonics and total-harmonic distortion (THD) of differential amplifiers by establishing a true-differential drive and tuning the PNA-X receivers to all desired harmonics
- Measure compression of differential mixers using power sweeps

Innovative Applications

Testing differential amplifiers under real operating conditions (S93460B)

Differential amplifier measurement challenges

- Conventional two-port VNAs with baluns do not provide common-mode, differential to common-mode, and common to differential-mode responses
- Baluns are inherently band-limited devices, which forces multiple test setups for broad frequency coverage
- Phase errors of baluns provide inaccurate differential responses
- Modern four-port VNAs provide mixed-mode S-parameter measurements with single-ended stimulus, but differential amplifiers may respond differently when in compression during real operating environments

PNA-X integrated true-mode stimulus application (iTMSA) provides:

- Mixed-mode S-parameters of differential amplifiers driven by true differential and common-mode signals
- Mismatch correction at the DUT input to minimize phase errors between two sources
- Input-only drive mode that prevents damage on amplifiers caused by stimulus on the output port
- In-fixture arbitrary phase offset and phase-offset sweeps to optimize input matching network for maximum amplifier gain

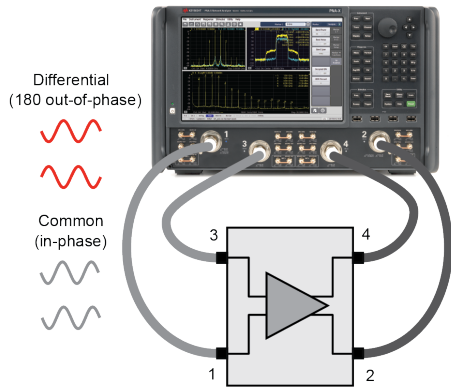

Figure 20. Using the PNA-X's two internal sources, iTMSA drives the differential amplifier under real world conditions, providing accurate mixed-mode S-parameters in all operating environments.

$$\begin{bmatrix} S_{DD11} & S_{DD12} & S_{DC11} & S_{DC12} \\ S_{DD21} & S_{DD22} & S_{DC21} & S_{DC22} \\ S_{CD11} & S_{CD12} & S_{CC11} & S_{CC12} \\ S_{CD21} & S_{CD22} & S_{CC21} & S_{CC22} \end{bmatrix}$$

Figure 21. Mixed-mode S-parameters.

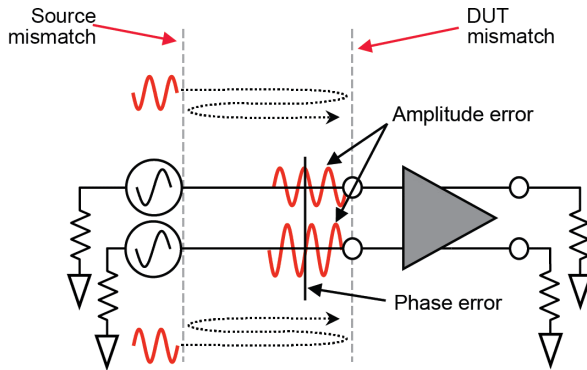

Figure 22. Without mismatch correction, the delivered signals to the DUT will not be truly differential due to reflection from the DUT input and the subsequent re-reflection from the sources. This effect can be corrected with mismatch correction.

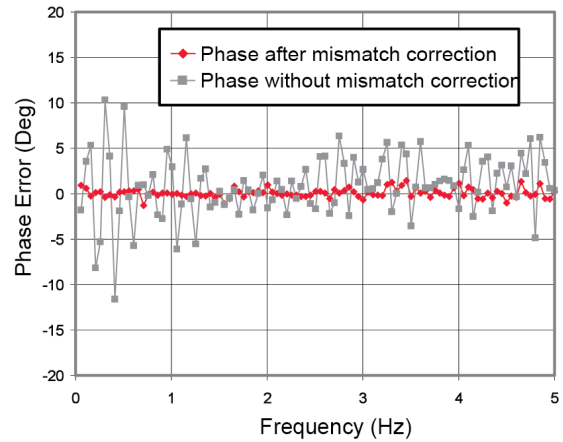

Figure 23. iTMSA compensates for mismatch errors by measuring the raw matches of the VNA and DUT, and precisely adjusting the amplitude and phase of the two signals at the reference plane to achieve ideal true-mode signals.

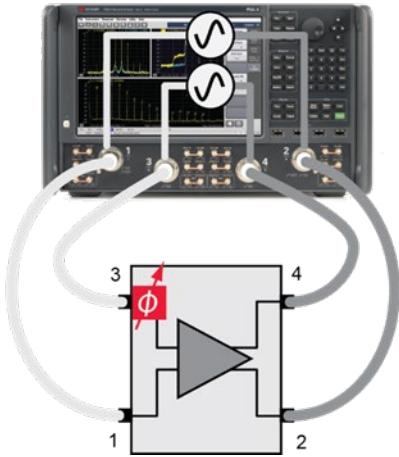

Figure 24. Phase-offset sweeps change the phase-offset value as if it were added in the fixture, enabling input-matching circuit validation.

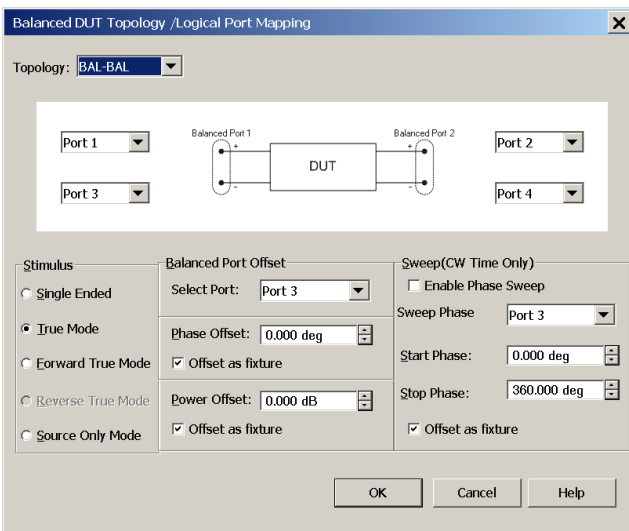

Figure 25. Various stimulus and sweep settings are available in the Balanced DUT Topology dialog, allowing you to select the right configuration for all of your balanced devices.

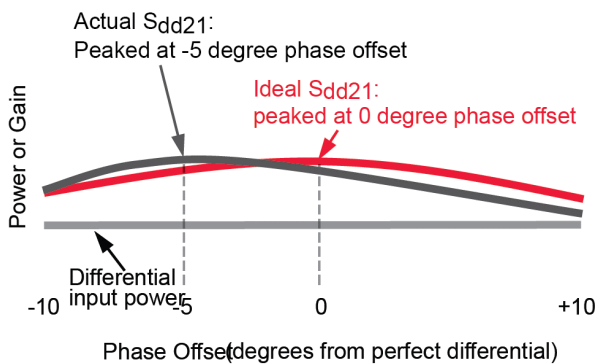

Figure 26. In-fixture phase-offset sweeps reveal the optimal phase offset to achieve the highest amplifier gain, which is essential to the design of the input matching circuit.

Tips from the Experts

- Input-only true-mode drive assumes a perfect match between the DUT output and the VNA's test ports, which is a good assumption when the DUT's reverse isolation is high. When the reverse isolation is low, adding attenuators on the output port improves the system match and reduces mismatch errors
- When comparing the test results between single-ended and true-mode drive conditions with the same effective delivered differential power, the individual port powers with true-differential drive must be set 6 dB lower than the port powers used with single-ended drive
- Single-ended drive
- $0 \text{ dBm port power} = -3 \text{ dBm differential power} + -3 \text{ dBm common-mode power}$
- True differential drive
- $3 \text{ dBm port power} = -6 \text{ dBm port 1 single-ended power} + -6 \text{ dBm port 3 single-ended power}$

Innovative Applications

One-box solution for high-speed serial interconnect analysis (S93011B)

TDR measurement challenges

- As bit rates of digital systems increase, fast and accurate analysis of interconnect performance in both time and frequency domains is critical to ensure reliable system performance
- Managing multiple test solutions to completely characterize differential high-speed digital devices is difficult

PNA TDR application provides:

- One-box solution for high-speed interconnect analysis, including impedance, S-parameters, and eye diagrams

Simple and intuitive operation

- The user interface is designed to provide a similar look and feel to traditional TDR oscilloscopes

Fast and accurate measurements

- Accurate measurements due to unmatched performance of the PNA-X / PNA / PNA-L Series vector network analyzers
- State-of-the-art error correction techniques enables you to measure your device, not your measurement system

High ESD robustness

- Protection circuits implemented inside the instrument significantly increase ESD robustness, while at the same time maintaining excellent RF performance
- Highly robust architecture minimizes instrument failure from ESD and frees you from worrying about instrument repair fees and downtime





Figure 27. Measurements are taken as a function of frequency. The frequency domain information is used to calculate the Inverse Fourier Transform for time domain results.

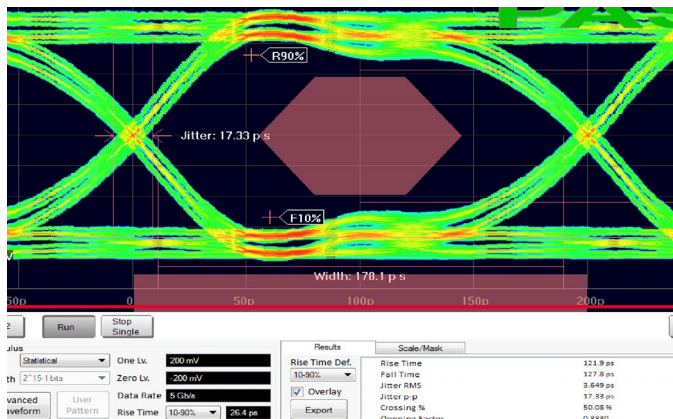

Figure 28. The simulated eye diagram analysis capability eliminates the need for a pulse pattern generator.

Tips from the Experts

- To convert from rise time to response resolution, multiply the rise time by c , the speed of light in free space. To calculate the actual physical length, multiply this value in free space by v_f , the relative velocity of propagation in the transmission medium. (Most cables have a relative velocity of 0.66 for a polyethylene dielectric, or 0.7 for a PTFE dielectric.)
- When testing multiple DUTs with different lengths, measure the DUT length using the longest DUT to allow for the use of the same instrument settings for all measurements
- Using high quality cables to connect the DUT is recommended in order to minimize measurement errors. The cables should have low loss, low reflections, and minimum performance variation when flexed
- When using Ecal, the DC Option (Option 0DC) is recommended for higher time domain accuracy

Innovative Applications

Powerful, fast and accurate automatic fixture removal (AFR) (S93007B)

Measurement challenges

Many of today's devices do not have coaxial connectors and are put in fixtures in order to measure them in a coaxial environment. Accurately removing the effects of the fixture is required to get a good measurement of the device under test (DUT).

Powerful AFR features can handle a variety of measurement needs

- Single ended and differential devices
- Left and right side of fixture can be asymmetrical
- Through lengths can be specified or determined from open or short measurements
- Band-pass time-domain mode for band-limited devices
- Extrapolation to match DUT frequency range
- Power correction compensates for fixture loss versus frequency
- De-embed files can be saved in a variety of formats for later use in PNA, ADS, and PLTS

AFR is the fastest way to de-embed a fixture from the measurement

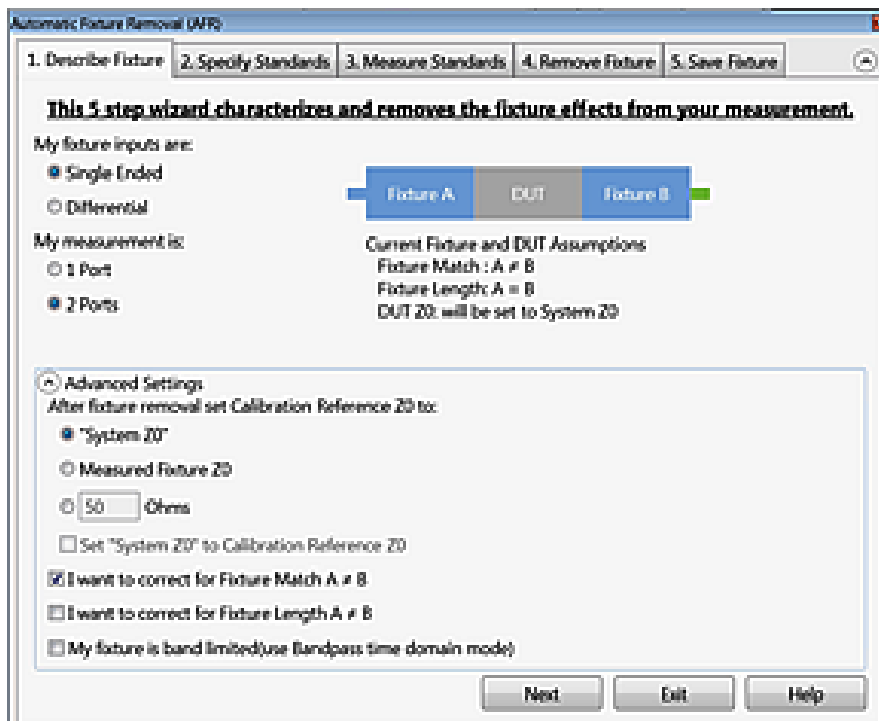

A five-step wizard guides you through the process to characterize your fixture and remove it from your measurement.

Yesterday without AFR

Complicated modeling in EM simulation software or multiple calibration standards fabricated on board were needed to characterize and remove a fixture.

Today with AFR

First calibrate in coax with the reference planes at the inputs to your fixture. Then measure one or more standards designed as a replica of the fixture's 2-port through, or fixture half terminated with an open or short.

Or, even faster: just measure the actual fixture itself before the DUT is installed for the open standard. AFR automatically characterizes and removes your fixture from the measurement.

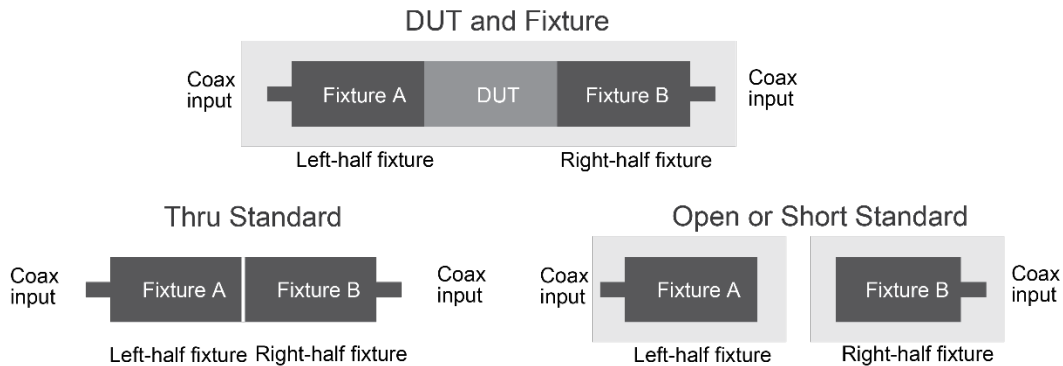

AFR accuracy is comparable to on-board TRL calibration, but much easier to accomplish.

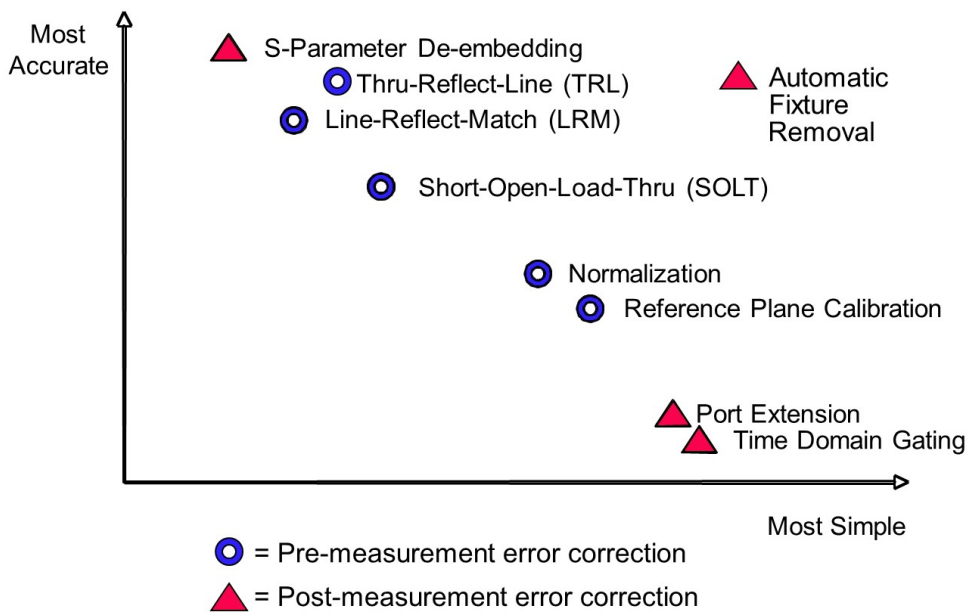
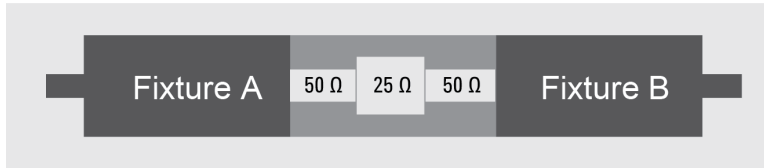

Figure 29. A relative comparison of various fixture error-correction methods

Measurement example



Beatty standard DUT

In the plots below, the green trace is a measurement of a Beatty Standard DUT before AFR fixture removal. The red trace is the DUT with AFR open-standard fixture removal. The blue trace is the DUT with AFR thru-standard fixture removal. The effects of fixture mismatch and length are removed from the DUT measurements. Good correlation is shown between the AFR open- and thru-standard fixture characterizations.

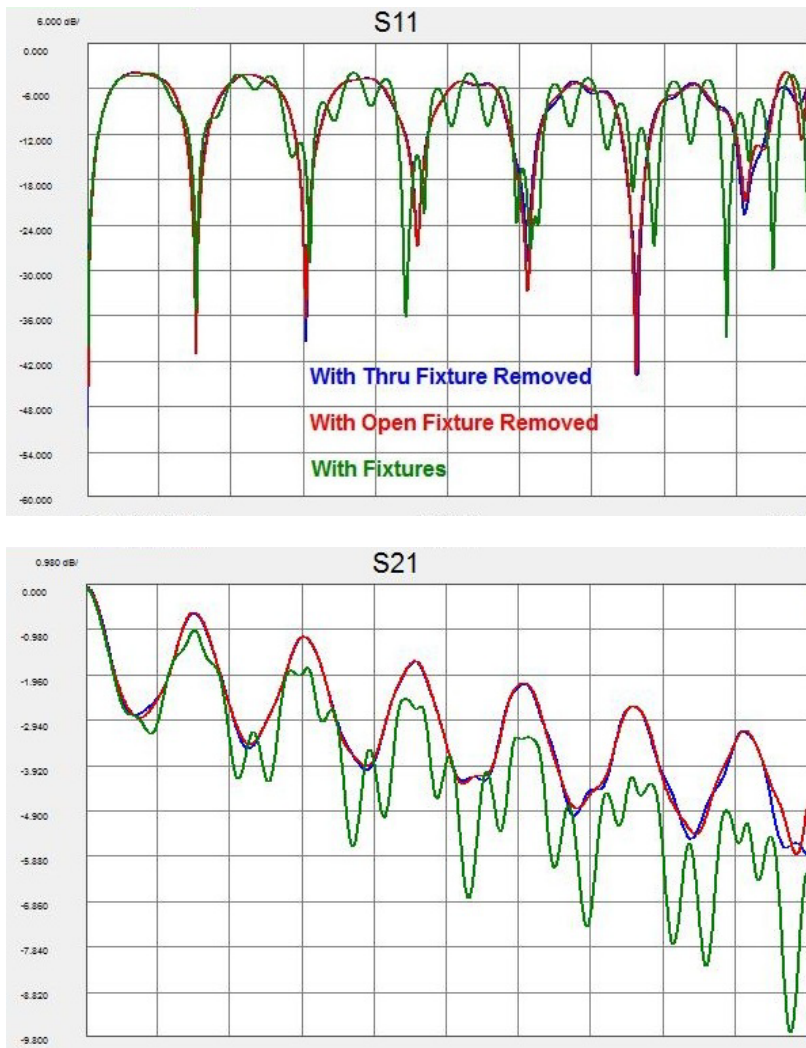

Figure 30. S11 and S21 in frequency domain

Innovative Applications

Extending the PNA-X to millimeter-wave frequencies

PNA-X's unique hardware architecture provides:

- Single-sweep millimeter-wave network analyzer configurations with frequency coverage from 900 Hz to 120 GHz
- Two- and four-port solutions for measurements on a wide variety of single-ended and balanced millimeter-wave devices
- Differential and I/Q measurements at millimeter-wave frequencies using two, phase-controlled internal sources
- Fully integrated solution for millimeter-wave pulsed-RF measurements using built-in pulse modulators and pulse generators
- Accurate leveled power at millimeter-wave frequencies with advanced source-power calibration methods
- Two internal sources allow direct connection of THz frequency-extender modules

Two- and four-port broadband, single-sweep solutions, 900 Hz to 120 GHz



N5290/91A PNA-X based 120 GHz millimeter-wave network analyzers are only available in four-port configurations. Two-port solutions are available using a two-port PNA network analyzer. N5290/91A broadband systems provide test capability to fully characterize passive, active, and frequency converting devices. These systems are compact replacements for N5251A systems, with superior performance and wider frequency range.

Two- and four-port banded configurations¹



1. Refer to Technical Overview, Banded Millimeter Wave Network Analysis, 5992-21 77EN for more information about banded configuration

millimeter-wave banded VNA is configured with N5292A test set controller and VDI frequency extenders. Terahertz measurements

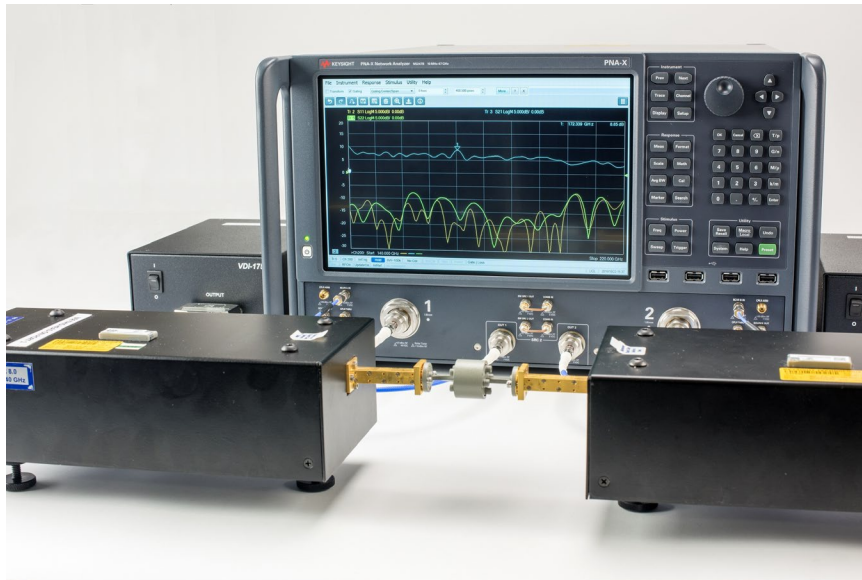

Figure 31. Direct connection of VDI modules to a four-port PNA-X enables S-parameter measurements to 1.5 THz.

Two-port direct connect system architecture

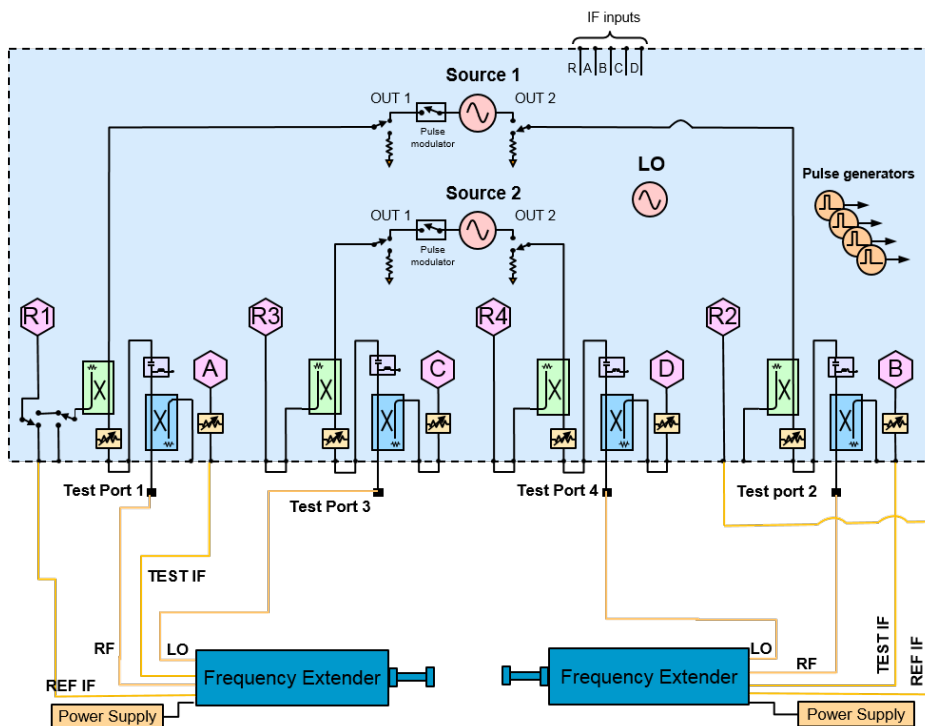

Figure 32. Block diagram of a two-port millimeter-wave system using a four-port PNA and two millimeter-wave frequency extenders.

Dynamic range improvement by 30 dB in sub-THz region

Measuring highly integrated devices in the sub-THz region brings new challenges. As the source signal is multiplied into millimeter frequencies, the phase noise also multiplies and decreases the dynamic range of the measurement with the N5292A test set and frequency extenders. The new PNA/-X signal sources with extremely low phase noise improve the measurement dynamic range within sub-THz frequency range from 70 dB to 100 dB.

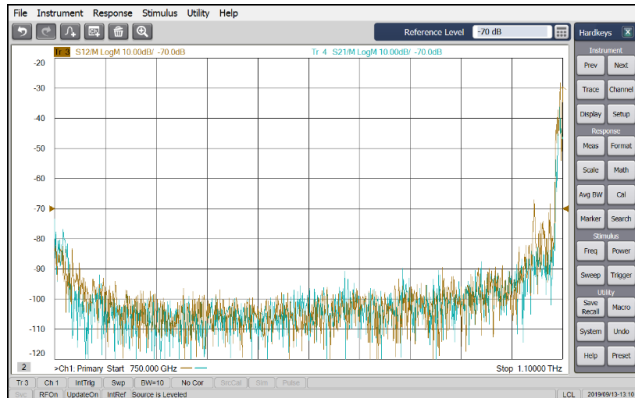
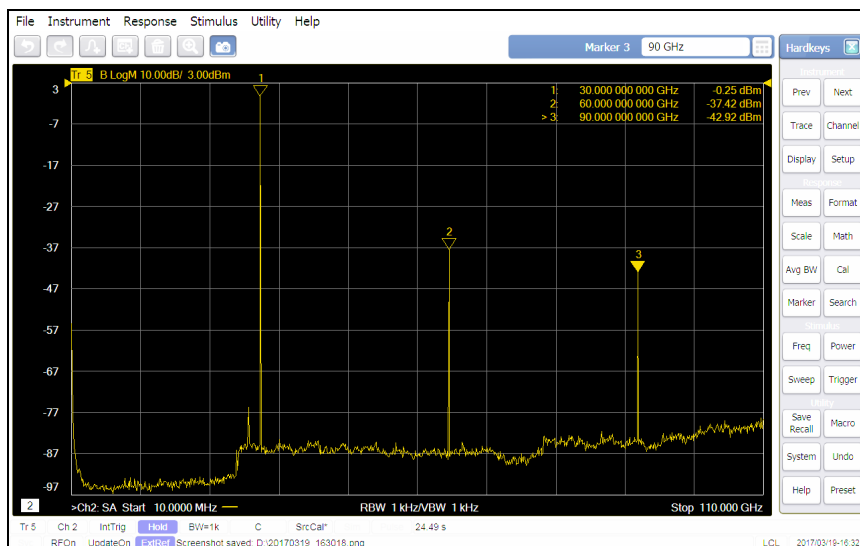

Figure 33. 100 dB dynamic range 750 GHz to 1.1 THz (IFBW = 10 Hz)

Millimeter-wave applications with the PNA-X

Millimeter-wave spectrum analysis

PNA-based millimeter-wave systems can take full advantage of spectrum analysis applications. This capability enables high-order harmonic and spur measurements at millimeter-wave frequencies.



The PNA's spectrum analyzer application is used to measure the harmonics of a millimeter-wave amplifier.

Multi-channel measurements at millimeter-wave frequencies

Fully characterize active devices at millimeter-wave frequencies using multiple PNA software applications, with a single set of connections or wafer touch-downs. Calibration of multichannel setups is easy using the Cal All Channels feature.



In addition to S-parameters, the spectrum analysis, gain compression, and differential I/Q applications are used to characterize a 10 MHz to 125 GHz amplifier.

Scalar mixer measurements

Measure conversion loss or gain plus input and output matches of mixers and frequency converters at millimeter-wave frequencies.

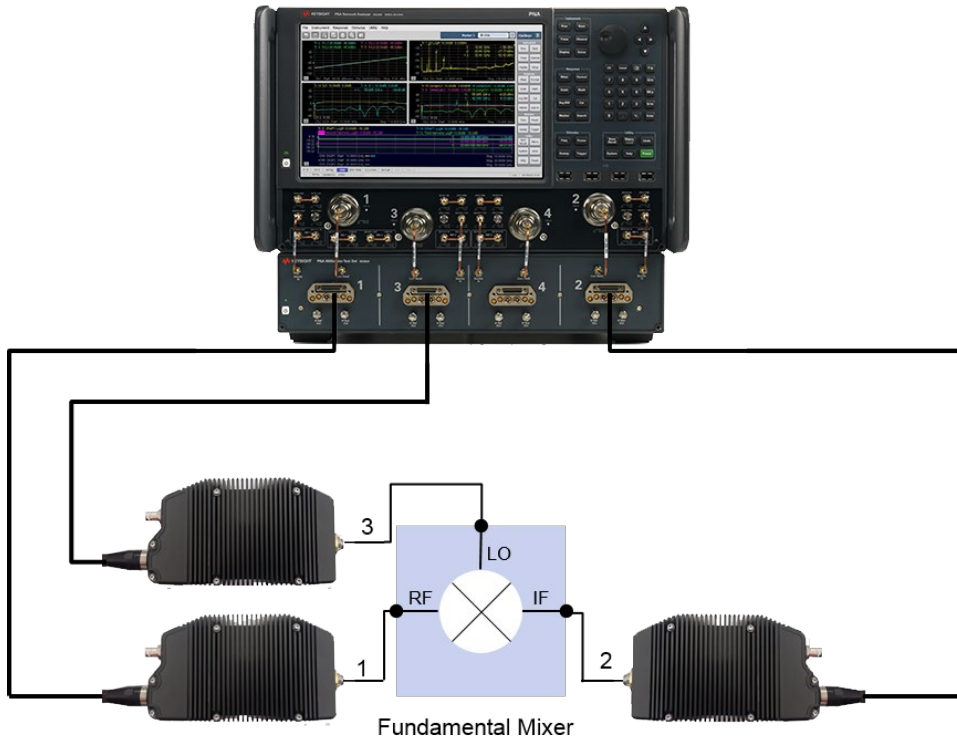

Figure 34. A dual-source PNA with an N5292A four-port controller and broadband frequency-extender modules characterize mixers and converters at millimeter wave frequencies. The PNA's second source can be used to provide an LO signal to a mixer.

Differential and I/Q measurements at millimeter-wave frequencies

- Highest measurement accuracy in the industry using advanced error- correction methods
- Integrated phase sweeps with power control

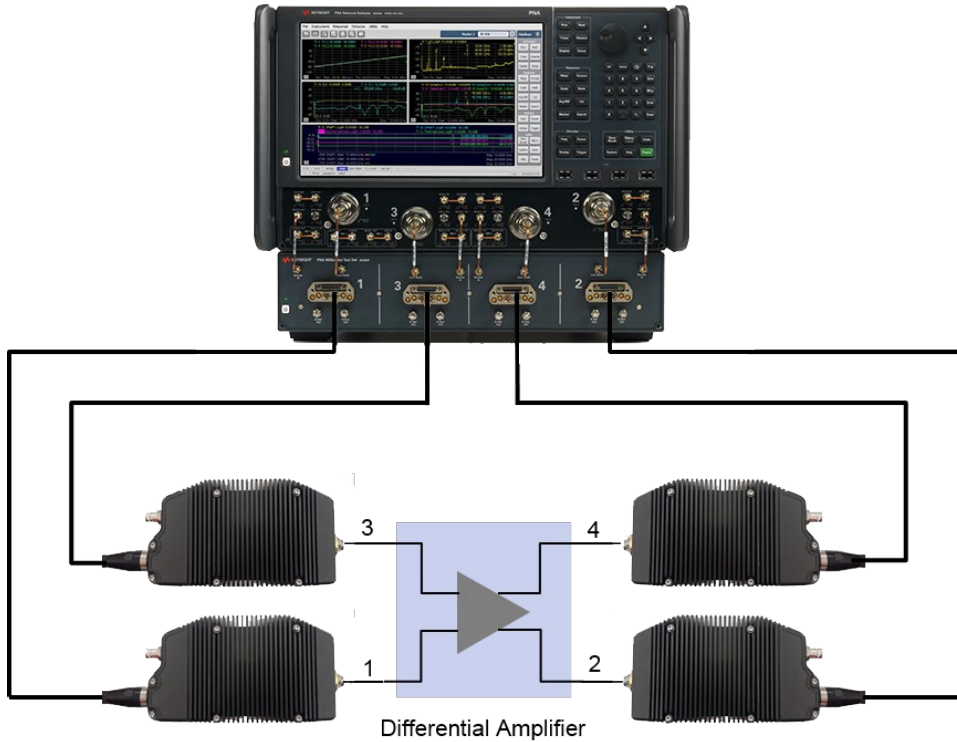

Figure 35. True-differential measurement of a balanced trans-impedance amplifier using a four-port PNA, the N5292A controller, and N5293A frequency extenders.



Tips from the Experts

- For repeatable calibrations, always use a torque wrench for the 1.0 mm calibration standards along with another wrench that prevents rotation of the test-port or test-cable connectors
- For repeatable measurements, ensure the cables between the instrument and extender modules are physically supported along their length
- Use Keysight's downloadable macro for easy configuration of direct-connect, banded millimeter-wave setups that don't require a test-set controller
- For multi-channel setups, use the Cal All Channels feature to simplify the calibration process

Refer to the Banded Millimeter Wave Network Analysis technical overview for more information, 5992-2177EN.

New 170 GHz / 220 GHz Broadband Vector Network Analysis

Enabling Insights into Broadband device performance

Keysight together with world-leading millimeter-wave solution partners offer a single-sweep VNA on-wafer solution operating from 900 Hz / 10 MHz – 170 / 220 GHz. This innovative solution has the best dynamic range, highest output power, and greatest stability over time in the industry. Designers can use these advantages to efficiently characterize on-wafer devices and circuits, enabling the creation of highly accurate PDK models that will shorten the design and verification cycle and allow faster deployment of devices for the emerging 5G and 6G MMICs. The solution comprises Keysight's N5291A industry-leading 125 GHz broadband VNA together with VDI's specially designed sub-THz frequency extenders and FormFactor T-Wave GSG Dual band probes with 50-to-100-um-pitch 1. This fully integrated solution using FormFactor's WinCal calibration software and standards enables accurate calibration to achieve the best measurement performance in the market. All of this has been carefully integrated onto FormFactor's industry leading Probing Systems insure ease of use.

Since it's based on the N5291A and uses VDI's sub-THz modules, it makes very simple to upgrade to this broadband VNA configuration.

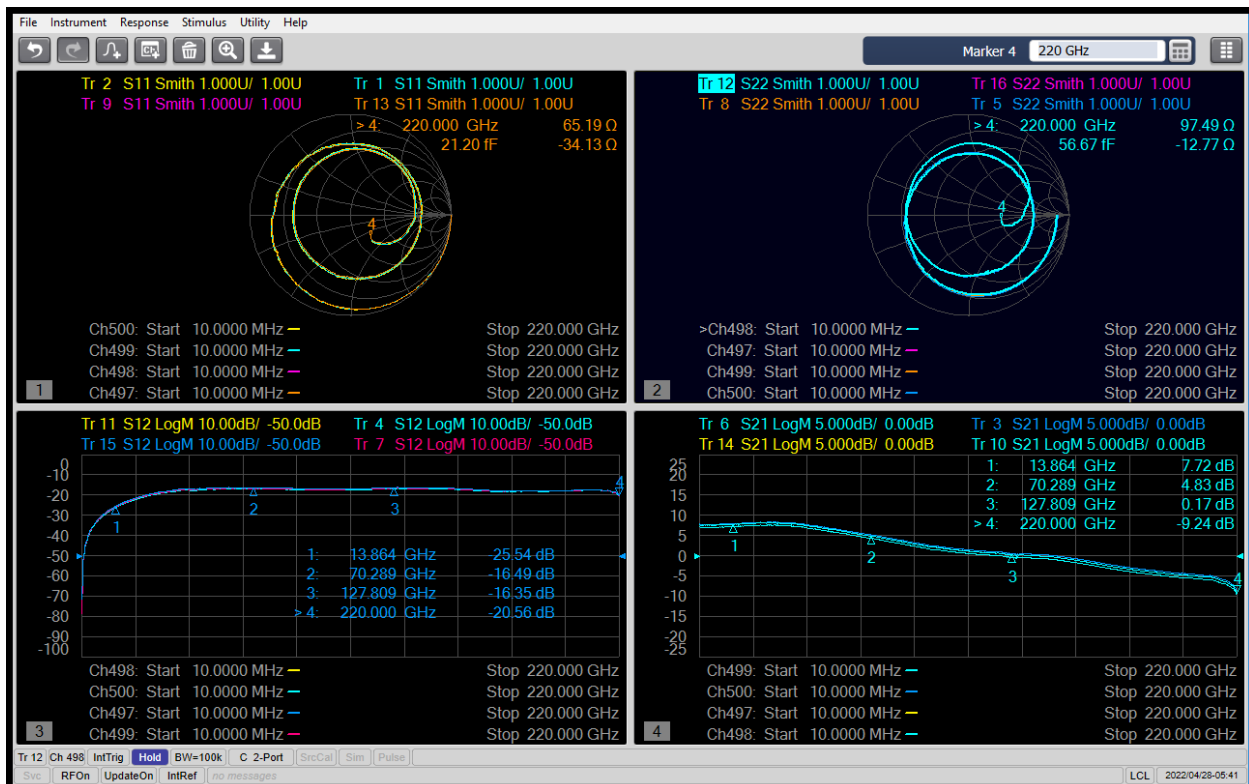

S-parameter measurement of an amplifier biased through N5295AX03 frequency extender bias tees. (2x15 μm CS pHEMT at Vg = -0.2 V and Vd = 3.5 V)

1. The FormFactor T-Wave probe is designed and Manufactured by DMPI. **3**

Solution Architecture

As mentioned above, the solution leverages Keysight N5291A broadband VNA, and it includes Keysight's N52xxB PNA network analyzer, N5292A 4-port test set controller and N5295AX frequency extenders. In addition, it uses VDI's 110 GHz to 170 GHz or 130 GHz to 220 GHz frequency extender module. The on-wafer device characterization is realized by the FormFactor T-Wave Dual Band Probe with its replaceable integrated probe chip technology.

170 GHz/220 GHz VNA solution



FormFactor T-Wave Dual band probe with integrated diplexer

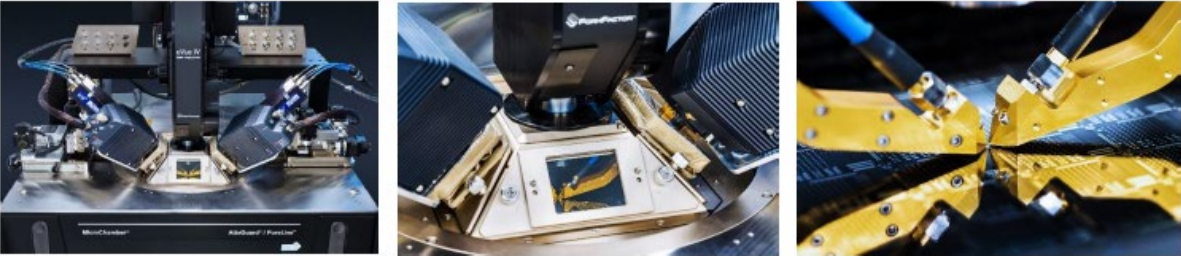

DMPI T-Wave Dual Probe, offered by Form Factor Inc.

Innovative Applications

Active hot parameters in nonlinear region (S93110B/111B) (PNA-X only)

Amplifier test challenges

- Amplifier characteristics depends on the impedance matching
- Amplifiers need to be tested under actual drive power
- The power delivered and the optimum load can be characterized with normal S22 S-parameter measurements in linear regions, but once the amplifier operates at high power, it goes into nonlinear regions, and the behavior can't be predicted
- Load-pull measurements using an actual load can be time consuming

Keysight's active hot parameters measurements makes tests easier and more accurate

- Hot S-parameters are appropriate for 50 Ω amplifiers where the transistors are pre-matched, and harmonics can be ignored.
- Proper correction for mismatch in the test system for amplifiers operating in the nonlinear (compression, saturation) region, ensures test system-to-system correlation across different test stands
- Perform accurate measurements in the nonlinear region by capturing the proper value of the optimum load that traditional Hot S22 measurements ignore
- Provides a measure of the true Hot S22 of the DUT in the manufacturing environment without any other hardware (100 times faster than nonlinear behavior analysis with NVNA)
- Provide the optimum match for maximum power and the value of the maximum power as well as power delivered to 50 Ω
- Provides fundamental X-parameters of the DUT

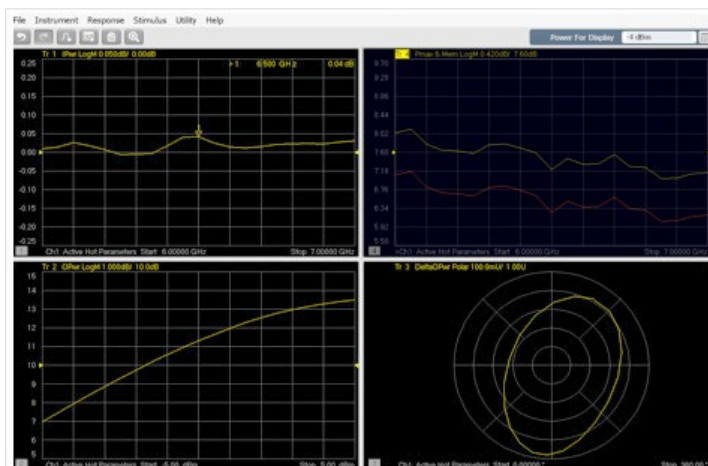

Multiple domain measurement with single sweep

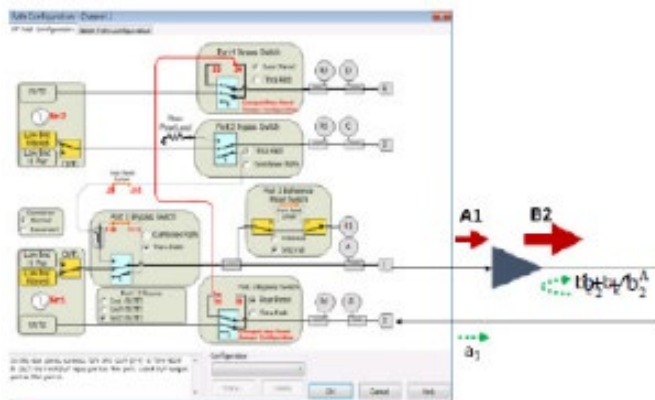

Hot S22 measurement with active parameter measurement function

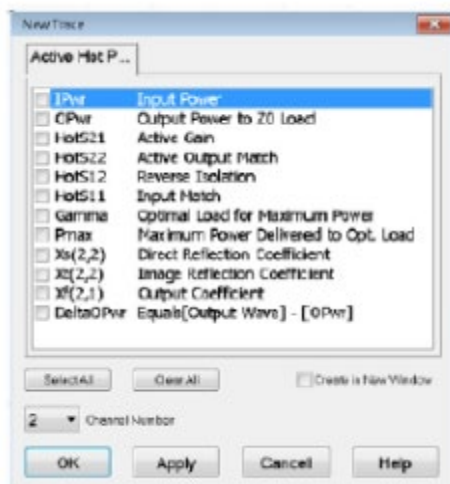

The active measurement provides fundamental X-parameters, hot parameters, and new measurement parameters: the optimum match for the maximum power (Gamma), the maximum power delivered to the optimum load (Pmax), and the total output power generated by the extraction tone (DeltaOPwr).

Tips from the Experts

- Active hot parameters are appropriate for amplifiers where the transistors are pre-matched, and are used to verify that the matching is good and there are not any extraneous matching issues
- Bare transistors, which require substantial impedance matching at fundamental and harmonic frequencies require testing with the nonlinear vector network analyzer and X-parameters (S945xxB)

Innovative Applications

Nonlinear waveform and X-parameter characterization (S94510/511/514/518/520/521/522B) (PNA-X only)

High-power design challenges

- Active devices are commonly driven into nonlinear regions, often by design to increase power efficiency, information capacity, and output power
- Under large-signal drive conditions, active devices distort time-domain waveforms, generating harmonics, intermodulation distortion, and spectral regrowth
- Current circuit simulation tools that rely on S-parameters and limited nonlinear behavioral models are no longer sufficient to fully analyze and predict nonlinear behavior of devices and systems
- Fewer design iterations are required to meet current time-to-market demands

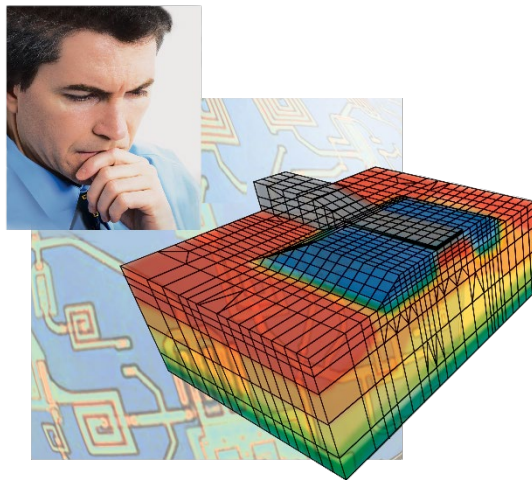

S-parameters in a nonlinear world

In the past, when designing systems with high-power amplifiers (HPAs), designers measured amplifier S-parameters using a vector network analyzer, loaded the results into an RF simulator, added other measured or modeled circuit elements, and then ran a simulation to predict system performance such as gain and power-efficiency under various loads.

Since S-parameters assume that all elements in the system are linear, this approach does not work well when attempting to simulate performance when the amplifier is in compression or saturation, as real-world HPAs often are. The errors are particularly apparent when simulating the combined performance of two cascaded devices that exhibit nonlinear behavior. While engineers may live with this inaccuracy, it invariably results in extensive and costly empirical-based iterations of the design, adding substantial time and cost to the design and verification process.

Breakthrough technology accurately characterizes nonlinear behaviors

Testing today's high-power devices demands an alternate solution — one that quickly and accurately measures and displays the device's nonlinear behavior under large signal conditions and provides an accurate behavioral model that can be used for linear and nonlinear circuit simulations. The Keysight nonlinear vector network analyzer (NVNA) and X-parameters provide that solution.

Keysight's award-winning NVNA goes beyond S-parameters to:

- Efficiently and accurately analyze and design active devices and systems under real-world operating conditions, to reduce design cycles by as much as 50%
- Gain valuable insight into device behavior with full nonlinear component characterization (S94510/511B)
 - Display calibrated time-domain waveforms of incident, reflected, and transmitted waves of the DUT in coaxial, in-fixture, or on-wafer environments
 - Show the amplitude and phase of all harmonic and distortion spectral products to design optimal matching circuits
 - Create user-defined displays such as dynamic load lines
 - Measure with full traceability to the National Institute of Science and Technology (NIST)
- Provide fast and powerful measurements of DUT nonlinear behavior using X-parameters (S94514B)
 - Extend linear S-parameters into nonlinear operating regions for accurate predictions of cascaded nonlinear device behavior using measurement-based data
 - Easily import the NVNA's X-parameters into Keysight's Advanced Design System (ADS) to quickly and accurately simulate and design nonlinear components, modules and systems
- Measure memory effects such as self-heating and signal-dependent bias changes (S94518B)
- Adds load-dependent nonlinear component behavior to X-parameters from external sources or external impedance tuners¹ (S94520B)
- Adds direct control of external sources or impedance tuners for load-dependent nonlinear X-parameters (S94521B)
- Captures large signal waveform under active loads for compact model generation (S94522B)
 - Nonlinear device behavior data overactive, arbitrary complex load impedances, input powers and DC biases can be used in IC-CAP for extracting Keysight's DynaFET compact model or used to generate customer's own power-transistor compact models.

1. Requires an additional load-control application.



Keysight's NVNA software applications and accessories convert a Keysight 4-port PNA-X network analyzer into a high-performance nonlinear vector network analyzer.

NVNA Nonlinear Measurements

ADS Simulation and Design

MDIF File

X-parameter blocks

X-parameters enable accurate nonlinear simulation under small to moderate mismatch conditions.

This allows prediction of component behavior in complicated nonlinear circuits.

Measure complete linear and nonlinear component behavior with the Keysight NVNA, and then accurately perform simulations and optimizations with Keysight's Advanced Design System.

For more information about the nonlinear waveform and X-parameter characterization, refer to NVNA brochure, 5989-8575EN.

Innovative Applications

Fast and accurate RF subsystem for antenna measurements

Challenges of antenna and radar cross-section (RCS) measurements

- Many data points must be collected, resulting in long test times
- In far-field and RCS measurements, signals can be close to the noise floor of the test receiver, resulting in noisy measurements
- Large installed-software base exists for 8530A antenna receivers, which have been discontinued and are no longer supported

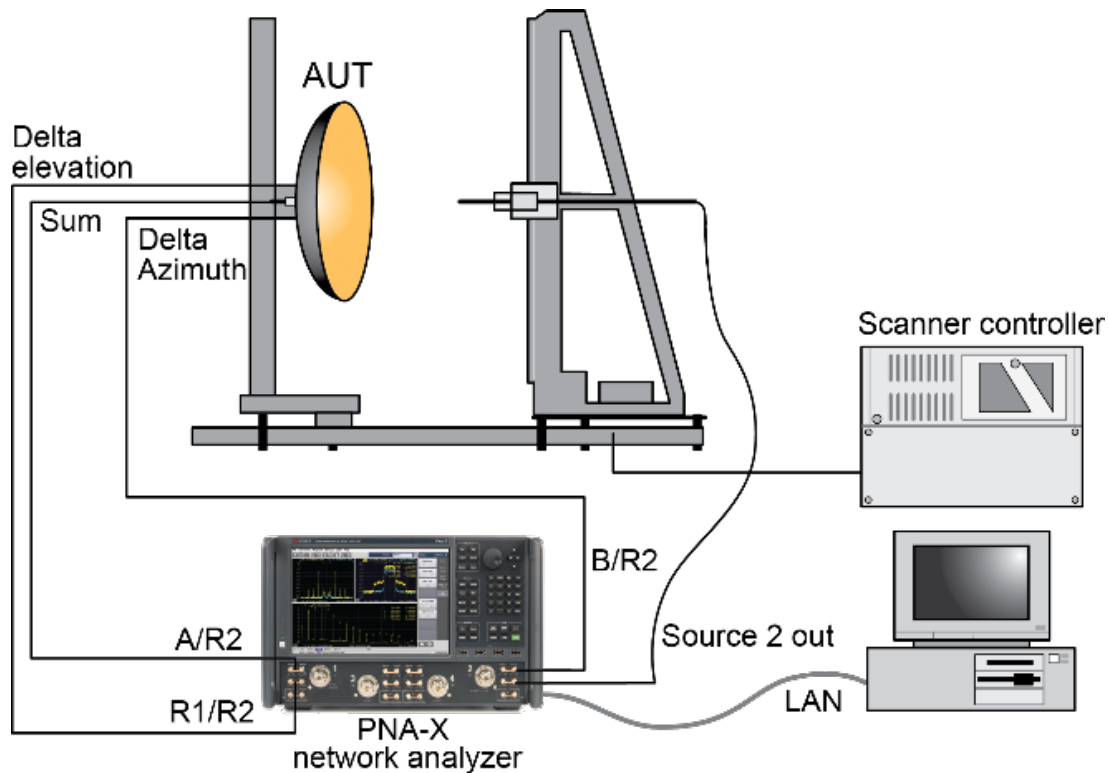

Figure 38. PNA-X configured for near-field measurements

PNA-X-based antenna solutions provide:

- Flexibility in system design: choose a standard PNA-X or an N5264B low-cost dedicated measurement receiver based on PNA-X hardware
- Fast measurements: 400,000 data points per second simultaneously on five receivers, yielding three to five times improvement in test times compared to the 8530A
- Large data collections with 500 million-point circular FIFO data buffer
- Excellent measurement sensitivity via selectable IF bandwidths and point-averaging mode
- Built-in 8530A code emulation for easy migration

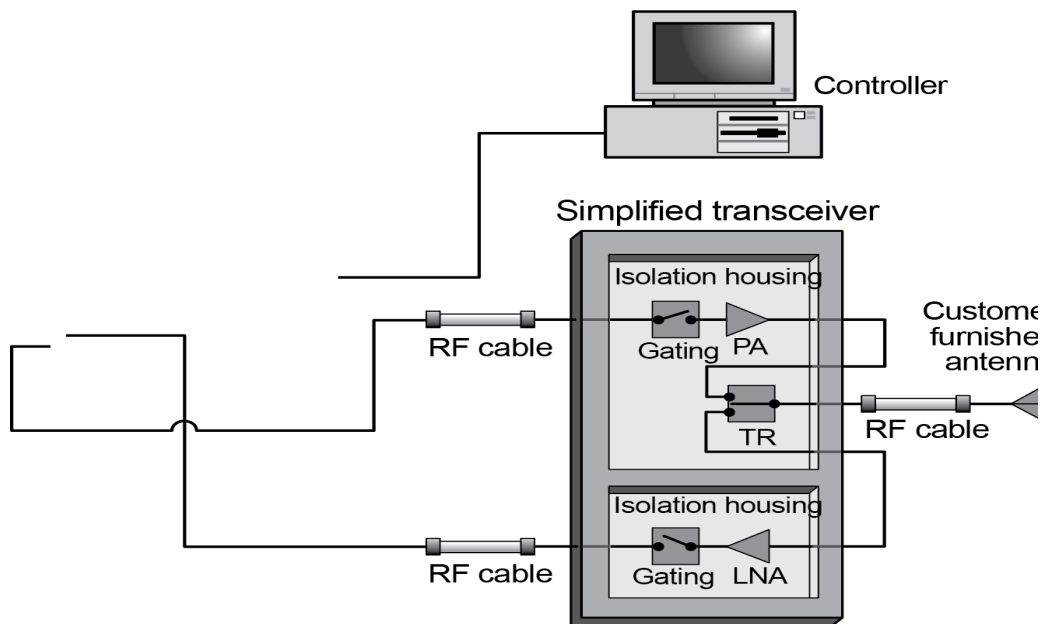

Figure 36. PNA-X configured for radar cross-section measurements 089

What is the best choice for an antenna receiver?

Application	N5264B measurement receiver	N524xB PNA-X	Comments
Near-field	No (requires external source)	Yes	Achieve faster measurement throughput with internal source Can use VNA for general-purpose component test
Compact range	Yes	Yes	Choice depends on the size of the antenna range
Far-field	Yes	No (higher cost)	Distributed approach increases measurement sensitivity by strategic placement of system components
Pulsed RF	No	Yes	PNA-X offers built-in pulse generators and modulators that simplify the system configuration

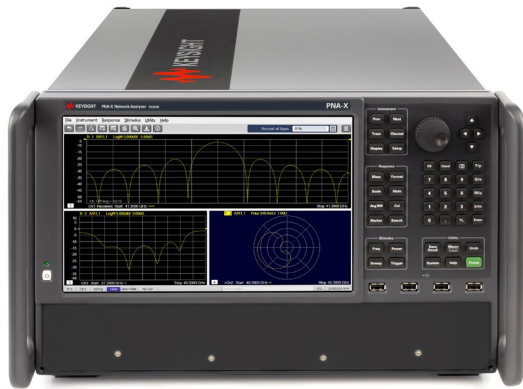

Figure 37. N5264B Measurement receiver

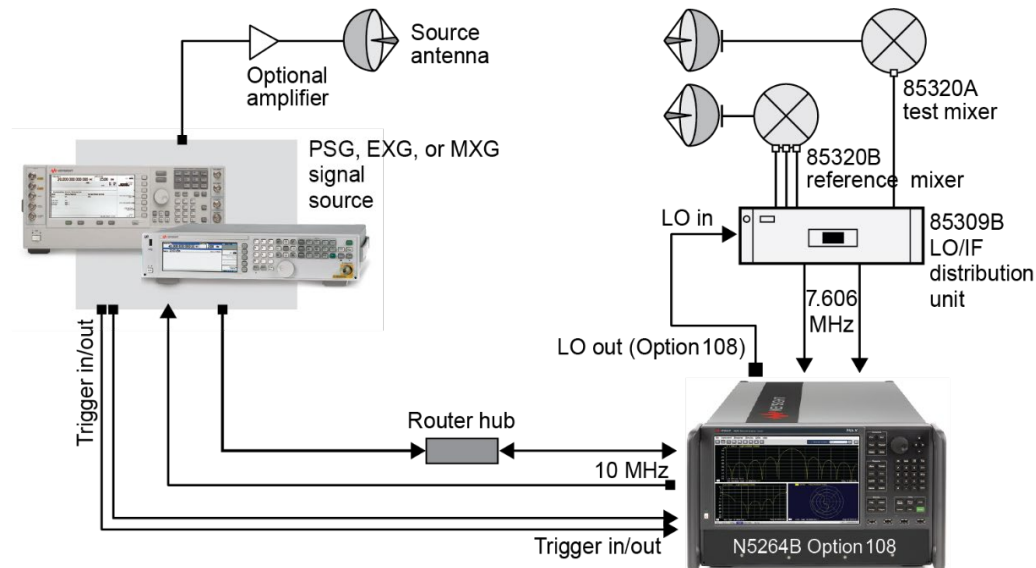

Figure 38. PNA-X measurement receiver configured for far-field measurements (PNA-X Option 020 with IF inputs can also be used).



Tips from the Experts

How can I control external sources?

1. Connect PNA-X to source via LAN or GPIB
2. Use External Device Configuration feature
3. Under Properties section:
 - Type name of external source, change Device Type to Source, and choose appropriate driver
 - Under Device Properties, choose between two trigger modes: Software CW (trigger cables not needed, but slow), or Hardware List (fast, but requires TTL triggers)
 - When the distance between the PNA-X and source is too far to use BNC trigger cables (> 40 meters), then a Keysight E5818A trigger box with LAN hub offers a good alternative

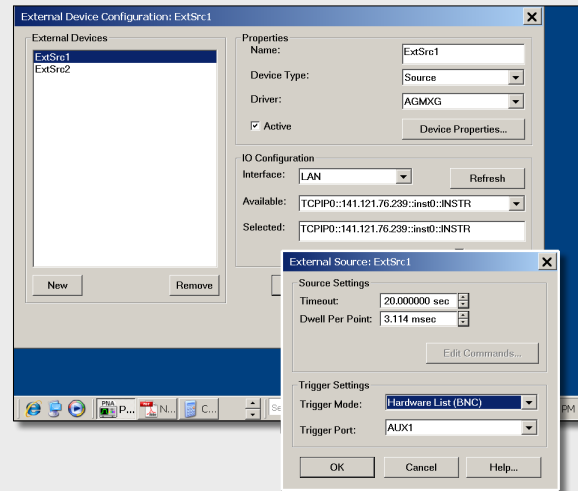

How do I get a common 10 MHz reference signal to my source and PNA-X when it's too far to use BNC cables?

- Use low-cost GPS-based satellite receivers to obtain high-accuracy 10 MHz reference signals
- Place a GPS receiver near the transmit source, and one near the PNA-X
- This approach works for arbitrary distances, from 100's of meters to many kilometers

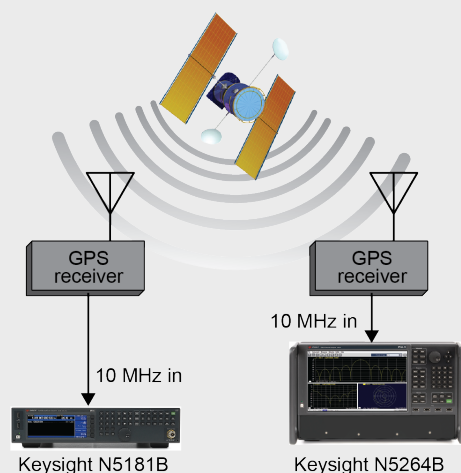

Extend the power of the PNA family to multiport devices

Multiport test challenges:

- Many components have more than 4 ports
- Moving test cables is slow and prone to errors
- Standard two-port calibration doesn't correct for ports outside the test path, resulting in degraded accuracy

PNA and PNA-X multiport solutions provide:

- Integrated test systems consisting of a network analyzer and an external multiport test set, seamlessly controlled by the PNA's firmware
- A single set of test connections to the DUT, resulting in high test throughput
- High accuracy with advanced calibration methods.
- Full compatibility with PLTS

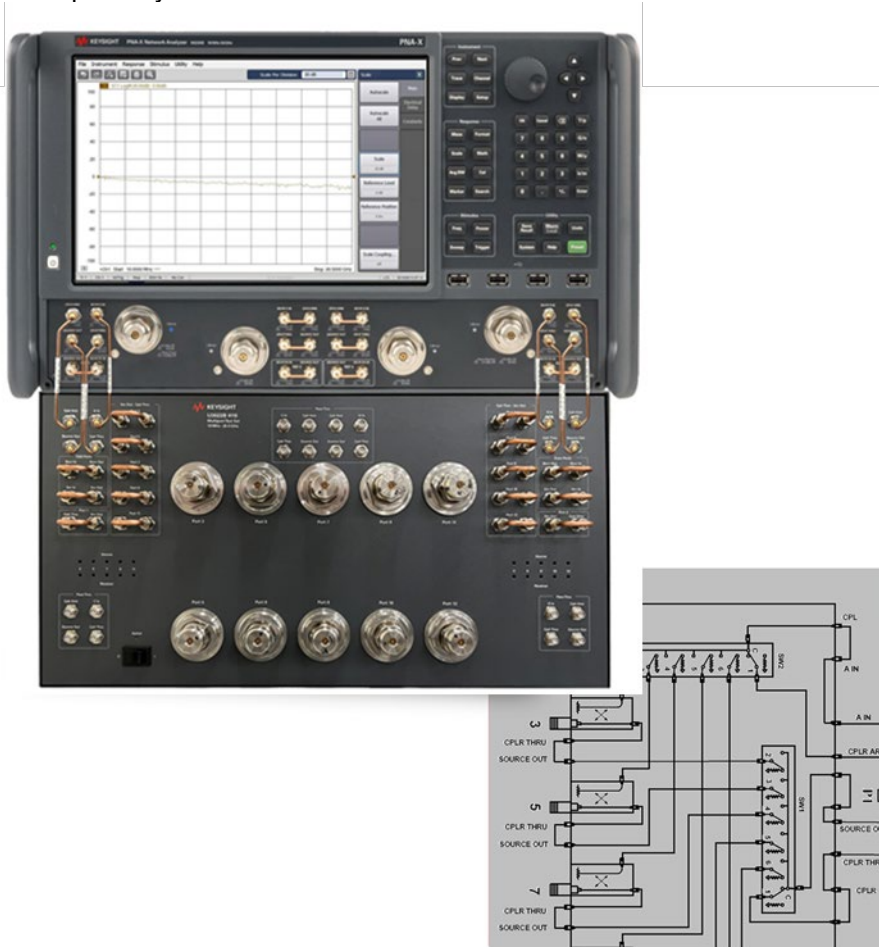

Flexible test set hardware

- Test couplers on each port provide accurate and stable measurements
- External signal conditioning hardware such as attenuators, amplifiers, or isolators can be added as needed to handle a variety of device types
- Get full cross-bar switching to cover any DUT, or limit the test paths to match those required by a specific DUT

Advanced calibration

- N-port calibration corrects the load match at all ports of the DUT, whether they are in the test path or not. This gives a high level of accuracy, independent of the isolation between ports of the DUT.
- QSOLT (quick short, open, load, thru) calibration reduces the number of correction standards required for full N-port calibration
- Application-specific calibrations to support compression, IMD, and noise figure can be applied in conjunction with the test set

Select Calibration Ports and ECal Module

Ports to Calibrate

<input checked="" type="checkbox"/> Port 1	<input checked="" type="checkbox"/> Port 2	<input checked="" type="checkbox"/> Port 3	<input checked="" type="checkbox"/> Port 4
<input checked="" type="checkbox"/> Port 5	<input checked="" type="checkbox"/> Port 6	<input checked="" type="checkbox"/> Port 7	<input checked="" type="checkbox"/> Port 8
<input checked="" type="checkbox"/> Port 9	<input checked="" type="checkbox"/> Port 10	<input checked="" type="checkbox"/> Port 11	<input checked="" type="checkbox"/> Port 12
<input checked="" type="checkbox"/> Port 13	<input checked="" type="checkbox"/> Port 14	<input checked="" type="checkbox"/> Port 15	<input checked="" type="checkbox"/> Port 16

Select All
Clear All

ECal Configuration

Selected Cal Kit: N4691-60001
Serial No.: 00141
Characterization: Factory

View/Select ECal Module

Show Advanced Settings (Orientation & Thru Cal Section) Calibrate source and receiver power

< Back Next > Cancel Help

Outstanding performance

Specification and feature comparison

PNA network analyzers

	N5221B/22B	N5224B/25B	N5227B
Frequency range	900 Hz/10 MHz to 13.5 GHz 900 Hz/10 MHz to 26.5 GHz	900 Hz/10 MHz to 43.5 GHz 900 Hz/10 MHz to 50 GHz	900 Hz/10 MHz to 67 GHz/ (70 GHz) ³
System dynamic range (at 20 GHz) ²	121 to 134 dB depending on configuration 149 to 156 dB with direct receiver access (typical)	121 to 132 dB depending on configuration 150 to 153 dB with direct receiver access (typical)	121 to 134 dB depending on configuration 148 to 153 dB with direct receiver access (typical)
Maximum output power at test port (at 20 GHz) ²	+13 dBm (Opt 200/1, 400/1) +10 dBm (Opt 205, 405) +10 dBm (Opt 217/9, 417/9) +8 dBm (Opt 220, 420) +7 dBm (Opt 210, 410)	+13 dBm (Opt 200/1, 400/1) +8 dBm (Opt 205, 405) +10 dBm (Opt 217/9, 417/9) +8 dBm (Opt 220, 420) +7 dBm (Opt 210, 410)	+11 dBm (Opt 200/1, 400/1) +9 dBm (Opt 205, 405) +8 dBm (Opt 219, 419) +6 dBm (Opt 220, 420) +5 dBm (Opt 210, 410)
Maximum power sweep range	38 dB (Opt 200/01/17/19, 400/01/17/19) 36 dB (Opt 205/220, 405/420) 32 dB (Opt 210, 410)	38 dB (Opt 200/01/17/19, 400/01/17/19) 35 dB (Opt 205, 405) 33 dB (Opt 220, 420) 32 dB (Opt 210, 410)	38 dB (Opt 200/01/19, 400/01/19) 36 dB (Opt 205, 405) 35 dB (Opt 220, 420) 32 dB (Opt 210, 410)
Phase Noise (at 10 GHz) with Option UNY (typical) ²	-94 dBc/Hz (100 Hz offset) -113 dBc/Hz (1 kHz offset) -127 dBc/Hz (10 kHz offset) -131 dBc/Hz (100 kHz offset) -143 dBc/Hz (1 MHz offset) -146 dBc/Hz (10 MHz offset)	-94 dBc/Hz (100 Hz offset) -113 dBc/Hz (1 kHz offset) -127 dBc/Hz (10 kHz offset) -131 dBc/Hz (100 kHz offset) -143 dBc/Hz (1 MHz offset) -146 dBc/Hz (10 MHz offset)	-94 dBc/Hz (100 Hz offset) -113 dBc/Hz (1 kHz offset) -127 dBc/Hz (10 kHz offset) -131 dBc/Hz (100 kHz offset) -143 dBc/Hz (1 MHz offset) -146 dBc/Hz (10 MHz offset)
Corrected specifications ¹	Dir 44 to 48 dB SM 31 to 40 dB LM 44 to 48 dB Refl trk +/- 0.003 to 0.006 dB Trans trk +/- 0.017 to 0.119 dB	Dir 35 to 41 dB SM 31 to 41 dB LM 35 to 41 dB Refl trk +/- 0.002 to 0.028 dB Trans trk +/- 0.021 to 0.17 dB	Dir 34 to 38 dB SM 34 to 42 dB LM 33 to 37 dB Refl trk +/- 0.019 to 0.033 dB Trans trk +/- 0.093 to 0.159 dB
Trace noise (at 20 GHz, IFBW = 1 kHz) ²	0.002	0.003	0.002

1. Dir = directivity; SM = source match; LM = load match; Refl trk= reflection tracking; Trans trk = transmission tracking

2. For lower frequency models than 20 GHz, refer to the data sheet

3. typical

PNA network analyzers

	N5221B/22B	N5224B/25B	N5227B
Harmonics (ports 1, 3) 10 MHz to 2 GHz > 2 GHz	-51 dBc typical -60 dBc typical	-51 dBc typical -60 dBc typical	-51 dBc typical -60 dBc typical
Bias tees, maximum current, voltage	± 200 mA, ± 40 VDC	± 200 mA, ± 40 VDC	± 200 mA, ± 40 VDC
Dimensions, H x W x D (with feet, handles)	280 x 459 x 578 mm	280 x 459 x 650 mm	280 x 459 x 650 mm
Weight (nominal net), 2-port 4-port	27 kg 37 kg	39 kg 42 kg	42 kg 45 kg

PNA-X network analyzers

	N5241/42/49B	N5244/45B	N5247B
Frequency range	900 Hz/10 MHz to 8.5 GHz 900 Hz/10 MHz to 13.5 GHz 900 Hz/10 MHz to 26.5 GHz	900 Hz/10 MHz to 43.5 GHz 900 Hz/10 MHz to 50 GHz	900 Hz/10 MHz to 67 GHz/ (70 GHz) ³
System dynamic range (at 20 GHz) ²	126 to 136 dB depending on configuration 125 to 158 dB with direct receiver access (typical)	127 to 135 dB depending on configuration 128 to 156 dB with direct receiver access (typical)	123 to 135 dB depending on configuration 134 to 153 dB with direct receiver access (typical)
Maximum output power at test port (at 20 GHz) ²	+13 dBm (Opt 201, 401) +10 dBm (Opt 21x, 22x, 41x, 422/3) +11 dBm (Opt 205) +8 dBm (Opt 425)	+13 dBm (Opt 201, 401) +10 dBm (Opt 21x, 22x, 41x, 422/3) +8 dBm (Opt 425)	+11 dBm (Opt 201, 401) +8 dBm (Opt 219, 419) +7 dBm (Opt 224, 423) +6 dBm (Opt 425)
Maximum power sweep range	38 dB 36 dB (Opt 205, 425)	38 dB 36 dB (Opt 425)	38 dB 36 dB (Opt 425)
Phase Noise (at 10 GHz) with Option UNY (typical) ²	-94 dBc/Hz (100 Hz offset) -113 dBc/Hz (1 kHz offset) -127 dBc/Hz (10 kHz offset) -131 dBc/Hz (100 kHz offset) -143 dBc/Hz (1 MHz offset) -146 dBc/Hz (10 MHz offset)	-94 dBc/Hz (100 Hz offset) -113 dBc/Hz (1 kHz offset) -127 dBc/Hz (10 kHz offset) -131 dBc/Hz (100 kHz offset) -143 dBc/Hz (1 MHz offset)	-94 dBc/Hz (100 Hz offset) -113 dBc/Hz (1 kHz offset) -127 dBc/Hz (10 kHz offset) -131 dBc/Hz (100 kHz offset) -143 dBc/Hz (1 MHz offset)

PNA-X network analyzers

	N5241/42/49B	N5244/45B	N5247B
		-146 dBc/Hz (10 MHz offset)	-146 dBc/Hz (10 MHz offset)
Corrected specifications ¹	Dir 44 to 48 dB SM 31 to 40 dB LM 43 to 47 dB Refl trk +/- 0.003 to 0.006 dB Trans trk +/- 0.044 to 0.16 dB	Dir 35 to 41 dB SM 31 to 41 dB LM 35 to 41 dB Refl trk +/- 0.002 to 0.028 dB Trans trk +/- 0.061 to 0.20 dB	Dir 34 to 41 dB SM 34 to 41 dB LM 33 to 40 dB Refl trk +/- 0.011 to 0.031 dB Trans trk +/- 0.065 to 0.17 dB
Trace noise (at 20 GHz, IFBW = 1 kHz) ²	0.002	0.002	0.002
Harmonics (ports 1, 3) 10 MHz to 2 GHz > 2 GHz	-51 dBc typical -60 dBc typical	-51 dBc typical -60 dBc typical	-51 dBc typical -60 dBc typical
Bias tees, maximum current, voltage	± 200 mA, ± 40 VDC	± 200 mA, ± 40 VDC	± 200 mA, ± 40 VDC
Dimensions, H x W x D (with feet, handles)	280 x 459 x 578 mm	280 x 459 x 650 mm	280 x 459 x 650 mm
Weight (nominal net), 2-port 4-port	27 kg 37 kg	46 kg 49 kg	46 kg 49 kg

1. Dir = directivity; SM = source match; LM = load match; Refl trk= reflection tracking; Trans trk = transmission tracking
 2. For lower frequency models than 20 GHz, refer to the data sheet
 3. typical

Configuration Information

For more detailed configuration information, refer to the PNA family configuration guide, 5992-1465EN.

Available options

Test set	Description	Additional information
Option 200 ³	2-ports, single source	
Option 201	2-ports, single source, and configurable test set	
Option 205	2-ports, single source, with configurable test set, bias tees, and low-frequency extension	All PNA models and N5241B/2B PNA-X models only.
Option 210 ³	2-ports, single source, metrology configuration	
Option 217 ²	2-ports, single source, configurable test set, source and receiver attenuators	Not available on N5247B
Option 219	2-ports, single source, configurable test set, source and receiver attenuators, and bias tees	
Option 220 ³	2-ports, single source, configurable test set, source and receiver attenuators, and bias tees and low-frequency extension	
Option 222 ^{2, 4}	2-ports, dual sources, configurable test set, source and receiver attenuators, combiner, and mechanical switches	Includes additional RF jumpers for maximum setup flexibility
Option 224 ^{1, 4}	2-ports, dual sources, configurable test set, source and receiver attenuators, combiner, mechanical switches, and bias tees	Includes additional RF jumpers for maximum setup flexibility
Option 400 ³	4-ports, dual sources	
Option 401 ¹	4-ports, dual sources, and configurable test set	
Option 405 ³	4-ports, dual sources, with configurable test set, bias tees, and low-frequency extension	
Option 410 ³	4-ports, dual sources, metrology configuration	
Option 417 ^{1, 2}	4-ports, dual sources, configurable test set, source and receiver attenuators	Not available on N5247B
Option 419 ¹	4-ports, dual sources, configurable test set, source and receiver attenuators, and bias tees	
Option 420 ³	4-ports, dual sources, configurable test set, source and receiver attenuators, and bias tees and low-frequency extension	

1. To independently control the frequency of the second internal source, one of the following software applications is required: S93080/029/082/083/084/086/087/089/090x/093/094B or S94510/511B

2. Recommended for high-power setups. The maximum power rating on the test port couplers is +43 dBm (additional attenuators or isolators are typically required to protect other components inside the instrument).

3. PNA models only.

Test set	Description	Additional information
Option 422 ^{1, 2, 3}	4-ports, dual sources, configurable test set, source and receiver attenuators, combiner, and mechanical switches	Includes additional RF jumpers for maximum setup flexibility
Option 423 ^{1, 3}	4-ports, dual sources, configurable test set, source and receiver attenuators, combiner, mechanical switches, and bias tees	Includes additional RF jumpers for maximum setup flexibility
Option 425 ^{1, 3}	4-ports, dual sources, configurable test set, source and receiver attenuators, combiner, mechanical switches, bias tees, and low- frequency extension	Includes additional RF jumpers for maximum setup flexibility
Additional hardware		
Option 020	Add IF inputs	Used for antenna measurements and mm-wave extenders
Option 021	Add pulse modulator to first source	
Option 022	Add pulse modulator to second source	Requires one of Option 22x, 40x, 41x, or 42x
Option 029 ³	Add low-noise receiver	S93029B application software is needed to control the noise receiver for noise figure and noise power measurements. For N5241/42/49B, requires one of options 21x, 22x, 41x, or 42x. For N5244/45/47B, requires one of options 22x or 42x. On N5247B, noise receiver works up to 50 GHz only.
Option E29 ⁴	Add low-noise receiver to 67 GHz (70 GHz typical)	S93029B application software is needed to control the noise receiver for noise figure and noise power measurements. Requires N5247B with Option 224, 423 or 425.
Option UNY	Enhanced low-phase noise	Export-controlled
Option XSB	Add third source	Available only with PNA-X with option 422 or 423

1. To independently control the frequency of the second internal source, one of the following software applications is required: S93080/029/082/083/084/086/087/089/090x/093/094B or S94510/511B
2. Recommended for high-power setups. The maximum power rating on the test port couplers is +43 dBm (additional attenuators or isolators are typically required to protect other components inside the instrument).
3. PNA-X models only.
4. N5247B PNA-X only.

PNA-X Series	Description	Additional information
Application software¹		
S93007B	Automatic fixture removal	
S93010B	Time domain analysis	
S93011B	Enhanced Time Domain Analysis with TDR	Provides TDR measurement class. S93010B is a subset of S93011B.
S93015B	Real time S-parameter and power measurement uncertainty	Displays the measurement uncertainty dynamically (real-time) on the measurement trace
S93025B	Basic pulsed-RF measurements	Includes control of internal pulse generators and provides pulse widths to 200 ns using wideband detection
S93026B	Advanced pulsed-RF measurements	Includes control of internal pulse generators and provides pulse widths to 100 ns using wideband detection, and 20 ns using narrowband detection.
S93027B ⁸	Add mechanical noise tuner control for noise figure/ parameter measurements	Provides ability to control Maury Microwave's LXI impedance tuners. Requires application software S93029B
S93029B	Noise figure measurements with vector correction ²	Standard receivers are used if hardware option N524xB-029 or E29 is not present
S930317B	Phase noise measurement up to 70 GHz	Direct Digital Synthesizer (DDS) source is required. (S/N prefix 6021 or after, or upgraded unit with N52xxBU-2S7 or 4S7)
S930321B	Phase noise measurement up to 125 GHz	This is for N5290A/91A or N5292A with N5293AX/95AX frequency extenders configuration. Direct Digital Synthesizer (DDS) source is required on PNA/ PNA-X (S/N prefix 6021 or after, or upgraded unit with N52xxBU-2S7 or 4S7)
S93050B	IQ data bandwidth up to 1.5 GHz	Requires VSA IQ Data link feature of either S93090xB Spectrum Analysis or S93070xB Modulation Distortion application
S93051B	IQ data bandwidth up to 4 GHz	Requires VSA IQ Data link feature of either S93090xB Spectrum Analysis or S93070xB Modulation Distortion application
S93052B	IQ data bandwidth up to 10 GHz	Requires VSA IQ Data link feature of either S93090xB Spectrum Analysis or S93070xB Modulation Distortion application
S930700B ⁸	Modulation distortion, up to 8.5 GHz	Requires configurable test set (It does not work with N522xB-200/210/400/410.) Requires a supported vector signal generator
S930701B ⁸	Modulation distortion, up to 13.5 GHz	Requires configurable test set (It does not work with N522xB-200/210/400/410.) Requires a supported vector signal generator

PNA-X Series	Description	Additional information
S930702B ⁸	Modulation distortion, up to 26.5 GHz	Requires configurable test set (It does not work with N522xB-200/210/400/410.) Requires a supported vector signal generator
S930704B ⁸	Modulation distortion, up to 43.5 GHz	Requires configurable test set (It does not work with N522xB-200/210/400/410.) Requires a supported vector signal generator
S930705B ⁸	Modulation distortion, up to 50 GHz	Requires configurable test set (It does not work with N522xB-200/210/400/410.) Requires a supported vector signal generator
S930707B ⁸	Modulation distortion, up to 70 GHz	Requires configurable test set (It does not work with N522xB-200/210/400/410.) Requires a supported vector signal generator
S930709B ⁸	Modulation distortion, up to 90 GHz	Requires configurable test set (It does not work with N522xB-200/210/400/410.) Requires a supported vector signal generator
S930712B ⁸	Modulation distortion, up to 125 GHz	Requires configurable test set (It does not work with N522xB-200/210/400/410.) Requires a supported vector signal generator. Export-controlled.
S930713B ⁸	Modulation distortion, up to and beyond 125 GHz	Requires configurable test set (It does not work with N522xB-200/210/400/410.) Requires a supported vector signal generator. Export-controlled.
S93080B	Frequency-offset measurements	Provides ability to independently set the frequency of internal sources and receivers, and to configure external sources. This functionality is included with S93029/082/083/084/086/087/089/090x/093/094B.
S93082B	Scalar mixer/converter measurements	Provides SMC measurement class. S93082B is a subset of S93083B.
S93083B	Vector and scalar mixer/converter measurements ³	Provides SMC+Phase and VMC measurement classes
S93084B	Embedded-LO capability	Works with S93029/082/083/086/087B
S93086B	Gain-compression measurements	
S93087B	Intermodulation distortion measurements ⁴	
S93088B	Source phase control	
S93089B	Differential and I/Q device measurements	Requires a 4-port test set option (4xx)
S930900B	Spectrum analysis, up to 8.5 GHz ⁵	
S930901B	Spectrum analysis, up to 13.5 GHz ⁵	
S930902B	Spectrum analysis, up to 26.5 GHz ⁵	
S930904B	Spectrum analysis, up to 43.5 GHz ⁵	

PNA-X Series	Description	Additional information
S930905B	Spectrum analysis, up to 50 GHz ⁵	
S930907B	Spectrum analysis, up to 70 GHz ⁵	
S930909B	Spectrum analysis, up to 90 GHz ⁵	
S93093B	Spectrum analysis, up to 125 GHz	Export-controlled
S93094B	Spectrum analysis, up to and beyond 125 GHz	Export-controlled
S93110B ⁸	Active hot parameters	Export-controlled
S93111B ⁸	Active hot parameters	Function-restricted version. The maximum operation is 50 GHz with N5247B
S93118B	Fast CW measurements	
S93300B	Broadband, 170 GHz	Export-controlled. For broadband 170 GHz VNA configuration including N5292A test set controller and N5295AX frequency extenders
S93301B	Broadband, 220 GHz	Export-controlled. For broadband 220 GHz VNA configuration including N5292A test set controller and N5295AX frequency extenders
S93460B	True-mode stimulus	Requires a 4-port test set option (4xx)
S93551B	N-port measurements ^{6,7}	
S94601B	Device measurement expert (DMX)	
S94602B	Limit assistant	
S94605B	Network Analyzer Test Setup Assistant	
S94610B	Digital Wideband Transceiver Analysis	Requires S9307xxB Modulation Distortion Application

1. Supported software license types: fixed-perpetual (1FP), transportable-perpetual (1TP), fixed-1-year (1FY), and transportable-1-year (1TY) (note: S93093B, S93094B, S93898B, and S94510B have fixed-license types only).
2. For N522xB and N5241/42/49B, vector-noise-corrected measurements require an ECal for use as an impedance tuner. For N5244/45/47B with Option 029, an internal tuner is included. Noise calibration requires a power meter when using a standard receiver. When using the low-noise receiver (Option 029), either a power meter or a 346-series noise source is required (Keysight 346C or 346C-K01 recommended). A power meter is required for measuring mixers and converters.
3. A configurable test set is required for VMC measurements to connect a reference mixer, or for SMC+Phase measurements using the comb-generator-based calibration. When ordered with PNA test set Options 200, 210, 400, or 410 (no front-panel jumpers), phase and delay measurements can only be done using SMC+Phase with a calibration mixer.
4. S93087B can be used without PNA-X Options 22x or 42x, but external equipment such as a signal generator and a combiner may be required.
5. A test set with internal receiver attenuators is recommended to avoid receiver compression when measuring large input signals.
6. When ordering a test set, select an appropriate interface kit.
7. When configured as a multipoint analyzer using S93551B and a multipoint test set, the combiner feature of Option 22x or 42x is temporarily disabled. When configured as a standalone analyzer, the combiner feature is enabled.
8. PNA/PNA-X models only.

PNA-X Series	Description	Additional information
Nonlinear vector network analysis		
S94510B ^{2,9}	Nonlinear component characterization	Export-controlled. Requires test set option 41x or 42x
S94511B ^{2,9}	Nonlinear component characterization	Function-restricted version. The X-parameter function is limited to 50 GHz. Requires test set option 41x or 42x
S94514B ^{3,9}	Nonlinear X-parameters ^{4,5}	Requires test set option 42x and application software S94510B
S94518B ⁹	Nonlinear pulse-envelope domain	Requires hardware option 021 and application software S94510B, and S93025B or S93026B
S94520B ⁹	Arbitrary load-impedance X-parameters ^{4,5}	Requires application software S94514B
S94521B	Arbitrary load-control X-parameters ^{4,5}	Requires application software S94520B
S94522B ⁹	Arbitrary load-control device characterization ^{7,8}	Requires application software S94510B or S94511B

1. A fully configured NVNA system requires two comb generators with power supplies, Keysight calibration kits (mechanical or ECal), and a power meter and sensor or USB power sensor.
2. Pulse capability requires option 021 and S93025B or S93026B.
3. Pulse capability requires option 021, 022 and S93025B or S93026B.
4. Requires EXG, MXG, or PSG signal generator for X-parameter extraction (the PNA-X's 10 MHz reference output can be used for 10 MHz tone-spacing applications).
5. X-parameters is a trademark and registered trademark of Keysight Technologies in the U.S., Europe, Japan, and elsewhere. The X-parameters format and underlying equations are open and documented. For more information, visit www.keysight.com/find/eesof-x-parameters-info.
6. Additional hardware required. Please refer to the analyzer's service guide for required service-test equipment.
7. Currently CW stimulus only.
8. Use of this application will generally require external sources, couplers attenuators, wafer probe station and more to complete system configuration. Please work with your local Keysight application engineer for details.
9. PNA-X models only.

Required NVNA accessories

- U9391C 10 MHz to 26.5 GHz or U9391F 10 MHz to 50 GHz or U9391G 10 MHz to 67 GHz comb generator (two required for nonlinear measurements)
- Keysight power meter and sensor or USB power sensor
- Keysight calibration kit, mechanical or ECal
- Keysight signal generator, EXG, MXG, or PSG, used for X-parameter extraction (the PNA-X's 10 MHz reference output can be used for 10 MHz tone spacing applications)

Accessories, calibration options

PNA-X Series	Description	Additional information
Accessories		
N524xB-1CM	Rack mount kit for use without handles	
N524xB-1CP	Rack mount kit for use with handles	
N1966A	Pulse I/O adapter	
U9391C/F/G	Comb generator ¹	
Calibration software		
S93898B	Built-in performance test software for standard compliant calibration	
Calibration documentation		
N524xB-1A7	ISO 17025 compliant calibration	
N524xB-UK6	Commercial calibration certificate with test data	
N524xB-A6J	ANSI Z540 compliant calibration	

Required NVNA accessories

- U9391C 10 MHz to 26.5 GHz or U9391F 10 MHz to 50 GHz or U9391G 10 MHz to 67 GHz comb generator (two required for nonlinear measurements)
- Keysight power meter and sensor or USB power sensor
- Keysight calibration kit, mechanical or ECal
- Keysight signal generator, MXG or PSG used for X-parameter extraction (internal 10 MHz reference output can be used for 10 MHz tone spacing applications)

Keysight software licensing options provide flexibility and support

Projects ramp up and down, teams grow and shrink, and projects move location. In such a dynamic environment, you need flexible licensing options that allow you to balance your project's requirements. Whether your software will be a staple for years to come or you have a short-term need for a leading-edge measurement application, Keysight's licensing puts you in charge.

Choose your term. Choose your type. Keep control of your budget.

- Select a node-locked, transportable, USB portable or floating license type, depending on how much flexibility you need.
- Select a subscription or perpetual license term, depending on how long you need to use the software.
- Each license is sold with a KeysightCare software support, which provides technical support with ensured response time, proactive software updates, and enhancements.

Choose a license term and type that best suits your requirements from the table below.

Table 1. License term

License term	Options
Perpetual	Licenses can be used indefinitely.
Subscription	Licenses can be used through the term of the subscription (6, 12, 24, or 36 months).

Table 2. License type

License type	Descriptions
Node locked	License can be used on one specified instrument/ computer.
Transportable	License can be used on one instrument/computer at a time but may be transferred to another using Keysight Software Manager (internet connection required).
USB portable	License can be used on one instrument/computer at a time but can be transferred to another using a certified USB dongle (available for additional purchase, Keysight part number E8900-D10).
Floating	Networked instruments/computers can access a license from a server one at a time. Multiple licenses may be purchased for concurrent usage. Three types of floating license are available: Single Site: 1-mile radius from the server Single Region ¹ : Americas, Europe, Asia Worldwide (export restriction identified in End User License Agreement (EULA))

1. Americas (North, Central, and South America, Canada); Europe (European Continent, Middle Eastern Europe, Africa, India); Asia (North and South Asia Pacific Countries, China, Taiwan, Japan)

KeysightCare Software Support Subscription provides peace of mind amid evolving technologies.

- Ensure your software is always current with the latest enhancements and measurement standards.
- Gain additional insight into your measurement problems with live access to our team of technical experts.
- Stay on schedule with fast turnaround times and priority escalations when you need support.

Table 3. KeysightCare software support subscription

Subscription	Descriptions
KeysightCare software support	Perpetual licenses are sold with a 12 (default), 24, 36, or 60-month software support subscription. Support subscriptions may be renewed for a fee after that. Software subscription licenses include software support through the term of the license.

Ordering information

- Step 1. Choose your software product.
- Step 2. Choose your license term: perpetual or subscription
- Step 3. Choose your license type: node-locked, transportable, USB portable, or floating.
- Step 4. Depending on the license term, choose your subscription or support duration.

License term

Product	License type	Perpetual		Subscription
		License	Support	License & Support
S93xxxB/ S94xxxB	Node-locked (fixed)	R-A5A-001-A	+ R-A6A-001-z	R-A4A-001-z
	Transportable	R-A5A-004-D	+ R-A6A-004-z	R-A4A-004-z
	USB Portable ¹	R-A5A-005-E	+ R-A6A-005-z	R-A4A-005-z
	Floating (single site)	R-A5A-002-B	+ R-A6A-002-z	R-A4A-002-z
	Floating (single region)	R-A5A-006-F	+ R-A6A-006-z	R-A4A-006-z
	Floating (worldwide)	R-A5A-010-J	+ R-A6A-010-z	R-A4A-010-z
			z = Duration	z = Duration
			L 12 months (default)	F 6 months
			X 24 months	L 12 months
			Y 36 months	X 24 months
			Z 60 months	Y 36 months

1. USB portable license requires a certified USB dongle (available for additional purchase, Keysight part number E8900-D10)

2. For S93xxxB software, the fixed-perpetual with a 12-months, support subscription (R-A6A-001-L) is the only license type that can be ordered as part of the instrument and installed. The other license types for S93xxxBs and all license types for S94601B/2B must be ordered separately and installed from the web after the receipt of the instrument.

Additional Information

Download the latest PNA-X application notes:

Bookmark this page to download the latest PNA-X application notes to gain in-depth measurement knowledge.

www.keysight.com/find/pnaxapps

Get answers online from factory experts:

Discuss calibration, applications, product, and programming topics at Keysight's online network analyzer discussion forum. Get answers to your toughest measurement and design challenges and browse prior discussion topics.

Welcome to the Network Analyzers forum! Please feel free to participate, ask questions, engage with our Keysight experts. The Keysight Forums are intended for peer-to-peer support and are also monitored by Keysight Employees. If you require a timely response, please contact your local [Keysight Technical Support](#).

TOPICS

- General Use
- Applications
- Programming and Remote Communications
- Calibration and Error Correction
- Handheld Analyzers

ASK NETWORK ANALYZERS

Type your question

Ask my question

ANSWERED QUESTIONS

- Can we automate the power testing on N6705B by using Labview sr7 3 weeks ago
- Error in description of Vector Voltmeter (option 308) on Keysight website drkirby 3 weeks ago
- In pathloss calculation, have I to include the antenna gains with S21 value? Thirumarai 3 weeks ago
- Calibration data for 85054A Kit gr8sailor 3 weeks ago

UNANSWERED QUESTIONS

- How to assign result after query :CALC1:MARK1:Y? RFresh 4 hours ago
- VNA Cal Kit Manager with Keysight Connection Expert on Windows 10, 64 bit Tedward 1 day ago
- power meter pmar ifbw myonezaki 1 day ago
- Are there AFR calibration fixture guidelines? RobRajk 1 week ago
- Adapter Characterization Andrew003 2 days ago
- What's the best/worst application note on

www.keysight.com/find/pna

www.keysight.com/find/na_forum



Keysight enables innovators to push the boundaries of engineering by quickly solving design, emulation, and test challenges to create the best product experiences. Start your innovation journey at www.keysight.com.

This information is subject to change without notice. © Keysight Technologies, 2017 - 2023, Published in USA, June 7, 2023, 5990-4592EN