

# General Purpose Switch Modules

## M9130A, M9131A, M9132A, M9133A, M9135A



### Introduction

### Product description

The PXI general purpose switch modules offer a variety of switch designs enabling you to select the best configuration for your test application. Choose a switch optimized for high speed or high power, available in either Form A (single-pole, single-throw) or Form C (single-pole, double-throw) configurations. The individual modules range from 20 channels up to 100 channels. The general purpose switches manage system controls by cycling power to your device under test (DUT), setting indicators and status lights, or actuating external power relays and solenoids.

Installation and configuration is fast and easy with standard cable connections or an optional connector block, soft front panels, and Keysight Connection Expert. In addition, software drivers support the most common programming environments such as Visual Studio, C, C++, Visual Basic, MATLAB, and LabVIEW.

### Applications

- Aerospace and defense
- Automotive
- Electronic test
- Medicalemiconductor

### Features

- Multiple configurations for fast and reliable high-density general purpose switching
- Up to 100-channel general purpose armature relays
- Power relay module
- Software drivers support the most common programming environments
- Optional connector blocks offer reliable measurements from robust, high-pincount interconnects
- Easy programming and control with soft front panels and Keysight Command Expert



## Uncompromising values

- High-density general purpose switching in a compact PXI module
- Get the performance you need to switch heavy loads with up to 300 W (DC resistive load)/1250 W (AC resistive load)
- Work in your programming environment of choice and reduce development time
- Fast and easy module installation and configuration
- Easier and faster PXI test system development

## Easy Setup, Test and Maintenance

### Hardware platform

#### Compliance

The general purpose switch modules are PXI compliant with a J1 connector and can be used in PXI chassis with cPCI (J1), PXI-1 (J1 only), or PXIe hybrid slot connectors.

The PXI format offers high performance in a small, rugged package. It is an ideal deployment platform for many automated test systems. In addition, a wide selection of complementary PXI products are currently available, such as multimeters, waveform generators, local oscillators, and digitizers.

### Software platform

#### IO Libraries

Keysight IO Libraries Suite offers fast and easy instrument connections and now extends to modular instruments. IO Libraries Suite 16 (or greater) adds support for PXI, helping you display all of the modules in your system, whether they are PXI, PXIe, or AXIe, as well as view information about installed software. In addition, the new version allows you to more easily find the right driver and start module soft front panels directly with Keysight Connection Expert.

#### Drivers

Keysight Technologies, Inc. provides instrument drivers that work with your choice of software, saving time and preserving software and hardware investments. Keysight modular instruments come with IVI-COM, IVI-C, and LabVIEW software drivers that work in the most popular test and measurement development environments including LabVIEW, MATLAB, LabWindows/CVI, Visual Studio C, C++, C#, VEE, and Visual Basic.

With a broad selection of drivers already included, any Keysight PXI general purpose switch can be swapped out, replaced, or upgraded with the latest version, requiring only minimal software adjustments.

### Easy software integration

In addition, application code examples are included for LabVIEW, LabWindows/CVI, Visual Studio C, C++, C#, Visual Basic, and MATLAB, providing switch setup and basic functionality. These application code examples are easily modified to quickly integrate the switch module into your measurement system.

## Software applications

Keysight soft front panels provide easy-to-use instrument communications. The PXI general purpose switch graphical user interface guides developers through module setup so users can quickly configure the switch states. Switch control is also possible through the wide selection of instrument program interfaces.

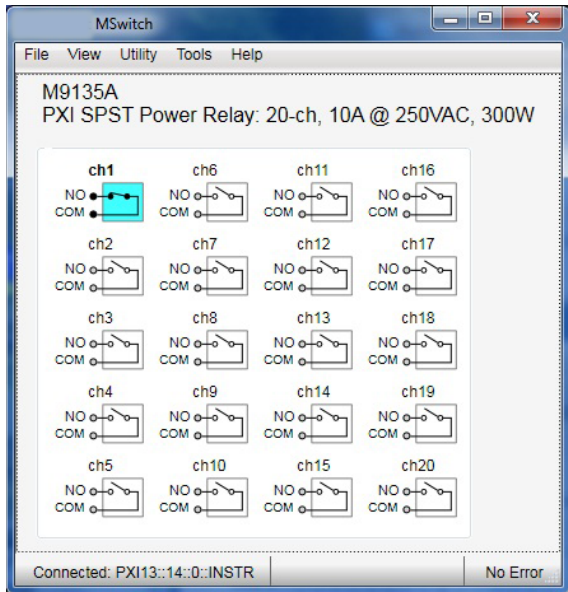

Figure 1. General purpose switch soft front panel

## Specifications and Characteristics



## Specification and characteristic summary

Following is a summary of specifications and characteristics for the Keysight PXI general purpose switches. More detailed specifications and characteristics for each module are featured later in this document.

General purpose switch specification and characteristic summary								
General purpose switches	Description	Type# slots	Channels	Switch speed (typical)	Max voltage (typical)	Current switch/carry (typical)	Relay type	Connectors
M9130A	SPDT switch	PXI 1-slot	26 Form C	2.7 msec	250 Vrms <sup>1</sup>	2 A/2 A	Armature	78 Dsub connector block or cable
M9131A	SPDT switch	PXI 1-slot	64 Form C	2 msec	100 Vrms <sup>1</sup>	0.25 A/1 A	Reed	200 LFH connector block or cable
M9132A	SPST switch	PXI 1-slot	50 Form A	0.35 msec	100 Vrms <sup>1</sup>	1 A/1 A	Reed	200 LFH connector block or cable
M9133A	SPST switch	PXI 1-slot	100 Form A	0.35 msec	100 Vrms <sup>1</sup>	1 A/1 A	Reed	200 LFH connector block or cable
M9135A	SPST switch	PXI 1-slot	20 Form A	10 msec	250 Vrms/ 125 Vdc	5 A/5 A	Armature	20 MSM connector block or cable

1. Not for connection to mains

## Specifications and Characteristics

### M9130A PXI SPDT switch: 26-ch, armature relays

The M9130A provides 26 channels using single-pole, double-throw (Form C) armature relays. This module design allows you to switch voltages up to 250 Vrms and current up to 2 A. The M9130A module is ideal for switching medium-power AC and DC loads, or slave-switching larger relays or solenoids. Easily connect to the front panel using a 78-pin, Dsub connector or cable.

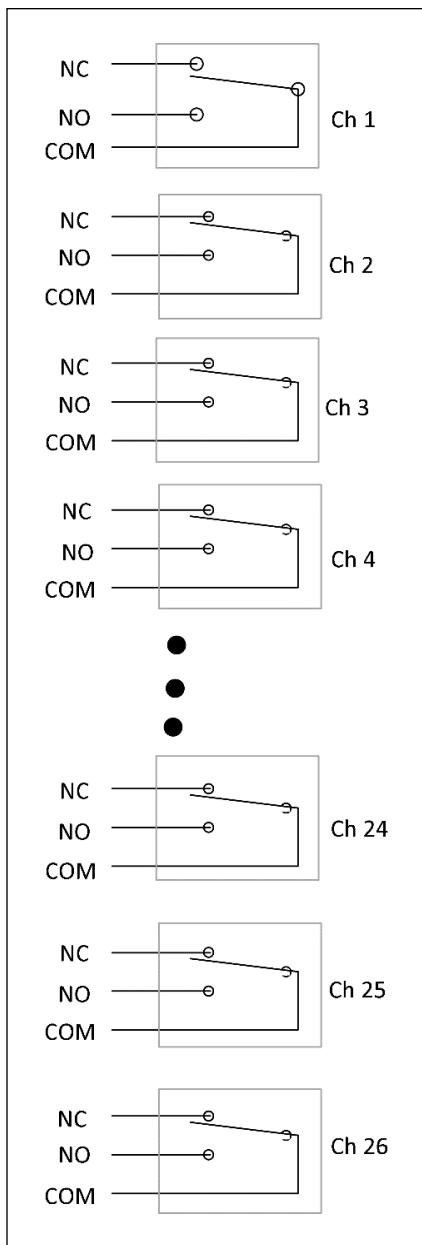

Figure 2. M9130A 26-ch, SPDT, armature relays

## M9130A specifications and characteristics

General specifications	
Channels	26
Switch type	SPDT, Form C, armature
Max volts	250 Vrms
Max current switch/carry	2A/2A

Switching characteristics (nominal)	
Max power	60 W
Switch speed (typical)	2.7 msec
Initial path resistance (typical)	< 500 mΩ
Connectors	78 Dsub connector block or cable
Bandwidth	5 MHz
DC isolation, Ch-Ch, Ch-Gnd	
25C / 40%RH (typical)	1x10 <sup>10</sup> Ω
25C / 80%RH (typical)	1x10 <sup>8</sup> Ω
40C / 80%RH (typical)	1x10 <sup>7</sup> Ω
Thermal offset (typical)	15 μV
Relay life, operations	
Low power load (typical)	> 2.5x10 <sup>6</sup>
Rated power load (typical)	> 1x10 <sup>5</sup>

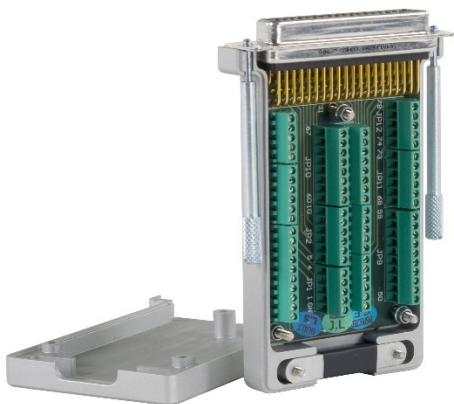

Figure 3. 78-pin Dsub connector block

## Specifications and Characteristics

### M9131A PXI SPDT switch: 64-ch, reed relays

The M9131A provides 64 channels using single-pole, doublethrow (Form C), high-speed, long-life reed relays. The module is designed for switching applications with signals up to 100 Vrms and 1 A, with up to 3 W power. Easily connect to the module through a high-density, 200-pin low force helix (LFH) connector or cable.

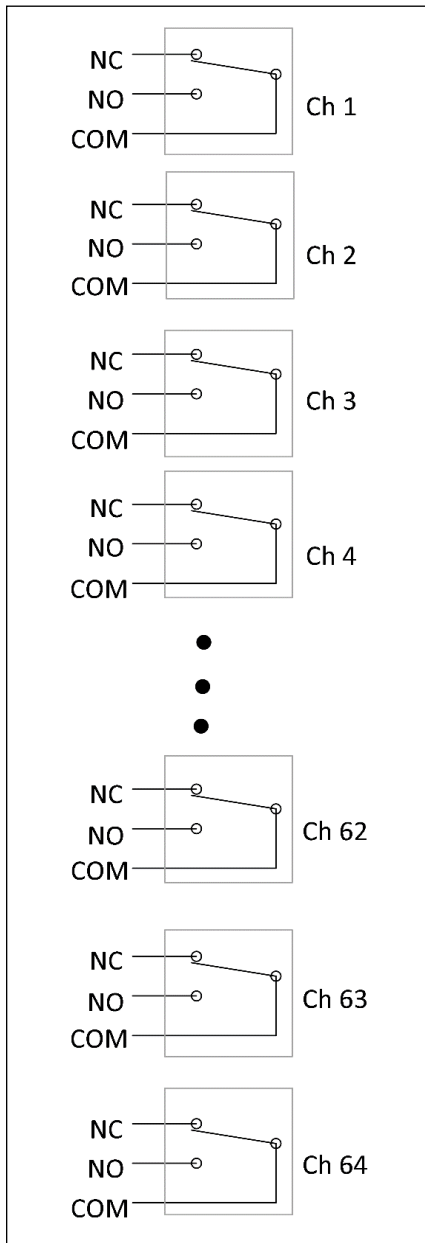

Figure 4. M9131A 64-ch, SPDT, reed relays

## M9131A specifications and characteristics

General specifications	
Channels	64
Switch type	SPDT, Form C, reed
Max volts	100 Vrms
Max current switch/carry	0.25 A/1.0 A

Switching characteristics (nominal)	
Max power	3 W
Switch speed (typical)	2.7 msec
Initial path resistance (typical)	400 mΩ
Connectors	200 LFHconnector block or cable
Bandwidth	10 MHz
DC isolation, Ch-Ch, Ch-Gnd	
25C / 40%RH (typical)	1x10 <sup>10</sup> Ω
25C / 80%RH (typical)	1x10 <sup>8</sup> Ω
40C / 80%RH (typical)	1x10 <sup>6</sup> Ω
Thermal offset (typical)	50 μV
Relay life, operations	
Low power load (typical)	1x10 <sup>9</sup>
Rated power load (typical)	> 1x10 <sup>6</sup>

1. Relay life is defined as path resistance <1.1 Ω



Figure 5. 200 pin LFH connector block

## Specifications and Characteristics

### M9132A PXI SPST switch: 50-ch, reed relays

The M9132A switch module is a general purpose, 50- channel, single-pole, single-throw (Form A) switch array. The module is designed with high-speed reed relays that enable switching for signals up to 100 Vrms and 1 A to 25 W power. The switches are ideal for powering your product on/off under test, or to actuate power relays and solenoids. Easily connect to the module through a high-density, 200-pin, low force helix (LFH) connector or cable.



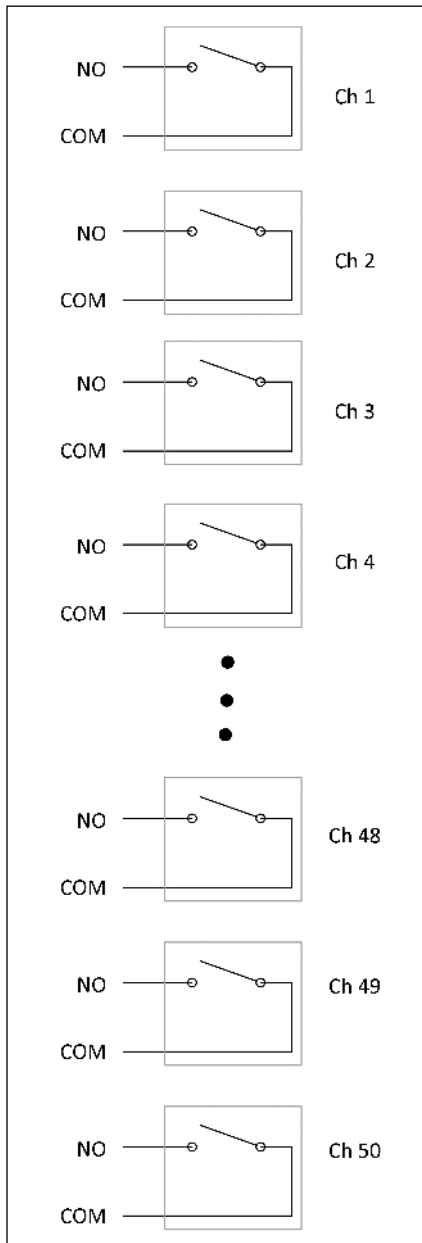

Figure 6. M9132A 50-ch, SPST, reed relays.

## M9132A specifications and characteristics

General specifications	
Channels	50
Switch type	SPDT, Form A, reed
Max volts	100 Vrms
Max current switch/carry	1 A/1 A

Switching characteristics (nominal)	
Max power	25 W
Switch speed (typical)	.35 msec
Initial path resistance (typical)	<500 mΩ
Connectors	200 LFHconnector block or cable
Bandwidth	5 MHz
DC isolation, Ch-Ch, Ch-Gnd	
25C / 40%RH (typical)	1x10 <sup>10</sup> Ω
25C / 80%RH (typical)	1x10 <sup>8</sup> Ω
40C / 80%RH (typical)	1x10 <sup>6</sup> Ω
Thermal offset (typical)	50 μV
Relay life, operations	
Low power load (typical)	1x10 <sup>9</sup>
Rated power load (typical)	> 1x10 <sup>6</sup>

1. Relay life is defined as path resistance <1.3 Ω

## Specifications and Characteristics

### M9133A PXI SPST switch: 100-ch, reed relays

For test environments that require many switches, such as manufacturing or R&D testing, the M9133A provides 100 channels of single-pole, single-throw (Form A), high-speed reed relays. Each channel has the ability to manage switching of 100 Vrms and 1 A, with up to 20 W power. Easily connect to the module through a high-density, 200-pin low force helix (LFH) connector or cable.

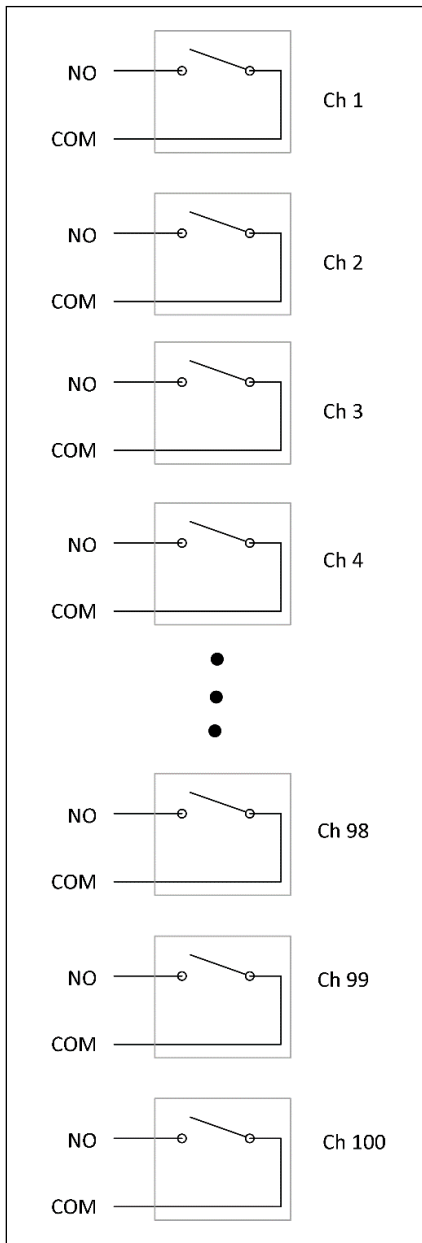

Figure 7. M9133A 100-ch, SPST, reed relays

## M9133A specifications and characteristics

General specifications	
Channels	100
Switch type	SPDT, Form A, reed
Max volts	100 Vrms
Max current switch/carry	1 A/1 A

Switching characteristics (nominal)	
Max power	25 W
Switch speed (typical)	.35 msec
Initial path resistance (typical)	<500 mΩ
Connectors	200 LFHconnector block or cable
Bandwidth	5 MHz
DC isolation, Ch-Ch, Ch-Gnd	
25C / 40%RH (typical)	1x10 <sup>10</sup> Ω
25C / 80%RH (typical)	1x10 <sup>8</sup> Ω
40C / 80%RH (typical)	1x10 <sup>6</sup> Ω
Thermal offset (typical)	50 μV
Relay life, operations	
Low power load (typical)	1x10 <sup>9</sup>
Rated power load (typical)	> 1x10 <sup>6</sup>

1. Relay life is defined as path resistance <1.4 Ω

## Specifications and Characteristics

### M9135A PXI 20-ch SPST switch

For your high power switching needs, the M9135A module provides 20 channels of single-pole, single-throw (Form A) relays suitable for switching inductive or capacitive loads. The module design consists of heavy-duty armature relays rated for resistive loads up to 300 W DC or 1250 W AC. Applications benefiting from this module include switching of heavy AC or DC loads, power supplies, and large system relays and solenoids. Connect to the front panel using the 20-pin MS-M connector or cable.

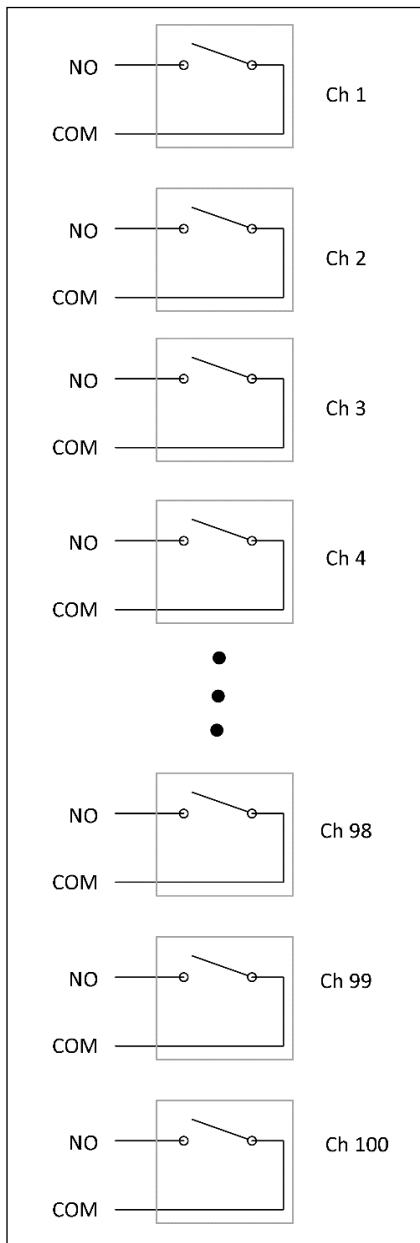

Figure 8. M9135A 20-ch, SPST, 10A, 300W

## M9135A specifications and characteristics

General specifications	
Channels	20
Switch type	SPDT, Form A, reed
Max volts	250 Vrms/125 Vdc
Max current switch/carry	5 A/5 A

Switching characteristics (nominal)	
Max power	300 W
Switch speed (typical)	10 msec
Initial path resistance (typical)	35 mΩ
Connectors	20 MSMconnector block or cable
Bandwidth	>20 MHz
DC isolation, Ch-Ch, Ch-Gnd	
25C / 40%RH (typical)	1x10 <sup>10</sup> Ω
25C / 80%RH (typical)	1x10 <sup>8</sup> Ω
40C / 80%RH (typical)	1x10 <sup>6</sup> Ω
Thermal offset (typical)	50 μV
Relay life, operations	
Low power load (typical)	1x10 <sup>9</sup>
Rated power load (typical)	> 1x10 <sup>6</sup>

1. Relay life is defined as path resistance <0.2 Ω

## Specifications and Characteristics

General specifications					
Slot type	PXI 1-slot				
Connector type	M9130A	M9131A	M9132A	M9133A	M9135A
	78 D connector block or cable	200 LFH connector block or cable	200 LFH connector block or cable	200 LFH connector block or cable	20 MSM connector block or cable

Environmental characteristics <sup>1,2</sup>	
Temperature	Operating: 0 °C to 55 °C Non-operating: -40 °C to +70 °C
Relative humidity	Relative humidity: Up to 95% R.H. at 40 °C, non-condensing, pollution degree 1
EMC	European EMC Directive 2004/108/EC - IEC/EN 61326-1 - CISPR Pub 11 Group 1, Class A - AS/NZS CISPR 11 - ICES/NMB-001 Canadian ISM device ICS-001

Safety	European Low Voltage Directive 2006/95/EC
	- ETL, UL/IEC/EN 61010-1, 2nd Edition
Altitude under relative humidity	Altitude: up to 4.6 km (15,000 ft)
Warm-up time	15 minutes, max

1. Samples of this product have been type tested in accordance with the Keysight Environmental Test Manual and verified to be robust against the environmental stresses of storage, transportation, and end-use; those stresses include, but are not limited to temperature, humidity, shock, vibration, altitude, and power line conditions.
2. Test methods are aligned with IEC 60068-2 and levels are similar to MIL-PRF-28800F class 3.

### Physical characteristics

- Dimensions
- 3U/1-slot PXI/CompactPCI standard
  - Connector slot compatibility: cPCI (J1), PXI 1, PXIe hybrid slot
  - Front panel complies with IEEE1101.10 certification and compliance

Weight	M9130A	M9131A	M9132A	M9133A	M9135A
	190 g (.42 lbs)	230 g (.51 lbs)	300 g (.66 lbs)	240 g (.53 lbs)	300 g (.66 lbs)

Table 9

### Power requirements

	M9130A	M9131A	M9132A	M9133A	M9135A
+3.3 V	0	0	0	0	0
+5 V	500 mA (400 ma typ)	1 A	500 mA	500 mA	200 mA
+12 V	0	0	0	0	15 mA per relay

## Specifications and Characteristics

### System requirements

Topic	Windows 7 and Vista Requirements	Windows XP Requirements
Operating systems	Windows 7 (32-bit and 64-bit)	Windows XP, Service Pack 3
	Windows Vista, SP1 and SP2 (32-bit and 64-bit)	
Processor speed	1 GHz 32-bit (x86), 1 GHz 64-bit (x64)	600 MHz or higher required
	(no support for Itanium 64)	800 MHz recommended
Available memory	4 GB minimum	3 GB minimum

	8 GB or greater recommended	
Available disk space <sup>1</sup>	1.5 GB available hard disk space, includes: <ul style="list-style-type: none"> <li>• 1 GB available for Microsoft .NET Framework 3.5 SP1<sup>2</sup></li> <li>• 100 MB for Keysight IO Libraries Suite</li> </ul>	1.5 GB available hard disk space, includes: <ul style="list-style-type: none"> <li>• 1 GB available for Microsoft .NET Framework 3.5 SP1<sup>2</sup></li> <li>• 100 MB for Keysight IO Libraries Suite</li> </ul>
Video	Support for DirectX 9 graphics with 128 MB graphics memory recommended (Super VGA graphics is supported)	Super VGA (800 x 600) 256 colors or more
Browser	Microsoft Internet Explorer 7.0 or greater	Microsoft Internet Explorer 6.0 or greater

1. Because of the installation procedure, less memory may required for operation than is required for installation.
2. NET Framework Runtime Components are installed by default with Windows Vista and Windows 7. Therefore, you may not need this amount of available disk space.

## Setup and Calibration Services

### Assistance

One day startup assistance	A Keysight Technologies applications engineer will help you get started and install the modules in a chassis, configure the controller, load software and make first measurements.	Included in base configuration
----------------------------	--	--------------------------------

### Calibration and Traceability

Factory Calibration	Keysight's modular products M9130A, M9131A, M9132A, M9133A, M9135A are factory calibrated and shipped with an ISO-9002, NIST-traceable calibration certificate.	Included in base configuration
---------------------	---	--------------------------------

Calibration Cycle A one year calibration cycle is recommended.

Calibration Sites	<ul style="list-style-type: none"> <li>• At Keysight Worldwide Service Centers</li> <li>• On-site by Keysight</li> <li>• By self-maintainers</li> </ul>	More information on <a href="http://www.keysight.com/find/infoline">www.keysight.com/find/infoline</a>
-------------------	---	--

R1282A Annual Calibration Service	<ul style="list-style-type: none"> <li>• Keysight Calibration</li> <li>• Keysight Calibration + Uncertainties</li> <li>• Keysight Calibration + Uncertainties + Guardbanding</li> <li>• Standards Compliance</li> <li>• ANSI Z540.3-2006, ISO 17025:2005, ANSI Z540-1-1994, ISO 9001:2008</li> </ul>	Additional service, not included in the warranty
-----------------------------------	--	--



## Configurations and Ordering

### Hardware

Model	Description
Each switch includes:	Getting started guide, software drivers, and Keysight I/O libraries
M9130A	PXI general purpose SPDT switch: 26-ch, 2 A, armature relays
M9131A	PXI general purpose SPDT switch: 64-ch, 100 Vrms/1A, reed relays
M9132A	PXI general purpose SPST switch: 50-ch, 100 Vrms/1A, reed relays
M9133A	PXI general purpose SPST switch: 100-ch, 100 Vrms/1A, reed relays
M9135A	PXI SPST switch: 20-ch, 5A, 300 W

### Accessories

M9130A	Description
Y1181A	PXI connector block: 78-pin, shielded, female DSub
Y1187A	PXI connector cable: 78-pin, male-to-female, 1 meter
Y1188A	PXI connector cable: 78-pin, male-to-female, 2 meter
M9131A, 32A, 33A	Description
Y1182A	PXI connector block: 200-pin, shielded, male
Y1189A	PXI connector cable: 200-pin, LFH male to four 50 pin Dtype female connectors, 1 meter
Y1190A	PXI connector cable: 200-pin, LFH male to four 50 pin Dtype female connectors, 2 meter
M9135A	Description
Y1191A	PXI power cable: 20-pin, female-to-unterminated, 1 meter
Y1192A	PXI power cable: 20-pin, female-to-unterminated, 2 meter
Y1193A	PXI power connector: 20-pin, female (universal), solder pin

Note: Although not required, the Positronic Industries 9099-0-0 Terminal Insertion Tool and the 9081-0-0 Terminal Removal Tool are recommended.

## Related products

Model	Description
M9018A	18-slot PXIe chassis: 18-slot, 3U, 8GB/s
M9021A	PCIe® cable interface: Gen 2, x8
M9045B	PCIe ExpressCard adaptor: Gen 1
Y1200B	PCIe cable: x4 to x8, 2.0m (used with M9045B)
M9048A	PCIe desktop PC adapter: Gen 2, x8
Y1202A	PCIe cable: x8, 2.0m (used with M9048A)

## Software

Model	Description
Supported operating systems	Microsoft Windows XP (32-bit), Microsoft Windows Vista (32/64-bit) Microsoft Windows 7 (32/64-bit)
Standard compliant drivers	IVI-COM, IVI-C, LabVIEW
Supported application development environments (ADE)	VisualStudio (VB.NET, C#, C/C++), LabVIEW, LabWindows/CVI, MATLAB
Keysight IO Libraries	Includes: VISA Libraries, Keysight Connection Expert, IO Monitor

## Recommended chassis configuration

For the ultimate in speed and flexibility, combine your switches with other PXI modules in the Keysight M9018A PXIe chassis as follows:

- Select a PXIe system module, PCIe cable interface, or embedded controller (the Keysight M9021A is recommended)
- If an external computer is being used, select an appropriate PC interface card (the Keysight M9047A is recommended with an external PC)
- Select an appropriate cable to connect the computer interface board to the system module (the Y1202A is recommended to connect the M9047A and M9021A)
- Select rack mount and EMC filler panel kits as required

## Definitions for specifications

Specifications describe the warranted performance of calibrated instruments that have been stored for a minimum of 2 hours within the operating temperature range of 0 to 55 °C, unless otherwise stated, and after a 45 minute warm-up period. Data represented in this document are specifications unless otherwise noted.

Characteristics describe product performance that is useful in the application of the product, but that is not covered by the product warranty. Characteristics are often referred to as Typical or Nominal values.

- Typical describes characteristic performance, which 80% of the instruments will meet when operated over a 20 to 30 °C temperature range. Typical performance is not warranted.
- Nominal describes representative performance that is useful in the application of the product when operated over a 20 to 30 °C temperature range. Nominal performance is not warranted.

Note: All graphs contain measured data from several units at room temperature unless otherwise noted.

Learn more at: [www.keysight.com](http://www.keysight.com)

For more information on Keysight Technologies' products, applications or services, please contact your local Keysight office. The complete list is available at: [www.keysight.com/find/contactus](http://www.keysight.com/find/contactus)

