

# Keysight Technologies

## 87104/6D Multiport Electromechanical Coaxial Switches

DC to 40 GHz

Technical Overview





## Introduction

Modern automated test systems demand higher accuracy and performance than ever before. The Keysight Technologies, Inc. 87104/6D electromechanical (EM) multiport switches offer improvements in insertion loss repeatability and isolation necessary to achieve higher test system performance. Long life, repeatability, and reliability lower the cost of ownership by reducing calibration cycles and increasing test system uptime, and are vital to automated test system (ATE) measurement integrity over time.

### High performance multiport switches for microwave and RF instrumentation and systems

- 0.03 dB repeatability ensures accuracy and reduces calibration cycles for the entire 5 million cycle operating life
- Excellent isolation, typically > 65 dB at 40 GHz maximizes measurement accuracy and improves system dynamic range
- Magnetic latching with SP4T and SP6T configurations

## Description

The Keysight 87104/6D SP4T EM multiport switches provide the life and reliability required for automated test and measurement, signal monitoring, and routing applications. Innovative design and careful process control create switches that meet the requirements for highly repeatable switching elements in test instruments and switching interfaces. The switches are designed to operate for more than 10,000,000 cycles. The exceptional 0.03 dB insertion loss repeatability is warranted for 5 million cycles at 25 °C. This reduces sources of random errors in the measurement path and improves measurement uncertainty. Switch life is a critical consideration in production test systems, satellite and antenna monitoring systems, and test instrumentation. The longevity of these switches increases system uptime, and lowers the cost of ownership by reducing calibration cycles and switch maintenance.

Operating to 40 GHz these switches exhibit exceptional isolation performance required to maintain measurement integrity. Isolation between ports is typically > 65 dB to 40 GHz. This reduces the influence of signals from other channels, sustains the integrity of the measured signal, and reduces system measurement uncertainties. These switches also minimize measurement uncertainty with low insertion loss and reflection, which make them ideal elements in large multi-tiered switching systems.

Both 87104/6D are designed to fall within most popular industry footprints. The 2¼ inch square flange provides mounting holes, while the rest of the 2½ inch long by 2¼ inch diameter body fits easily into most systems. Ribbon cable or optional solder terminal connections accommodate the need for secure and efficient control cable attachment.

Option 100 provides solder terminal connections in place of the 16-pin ribbon drive cable. Option 100 does not incorporate the “open all paths” feature.

Opto-electronic interrupts improve reliability and extend the life of the switch by eliminating DC circuit contact failures characteristic of conventional electromechanical switches. The 87104/6D switches have an interrupt circuit that provides logic to open all but the selected ports, and then close the selected paths. All other paths are terminated with 50 ohm loads, and the current to all the solenoids is then cut off. These versions also offer independent indicators that are controlled by optical interrupts in the switch. The indicators provide a closed path between the indicator common pin and the corresponding sense pin of the selected path.



Figure 1. Keysight 87104D/6D high performance EM switches have a typical operating life of 10 million cycles

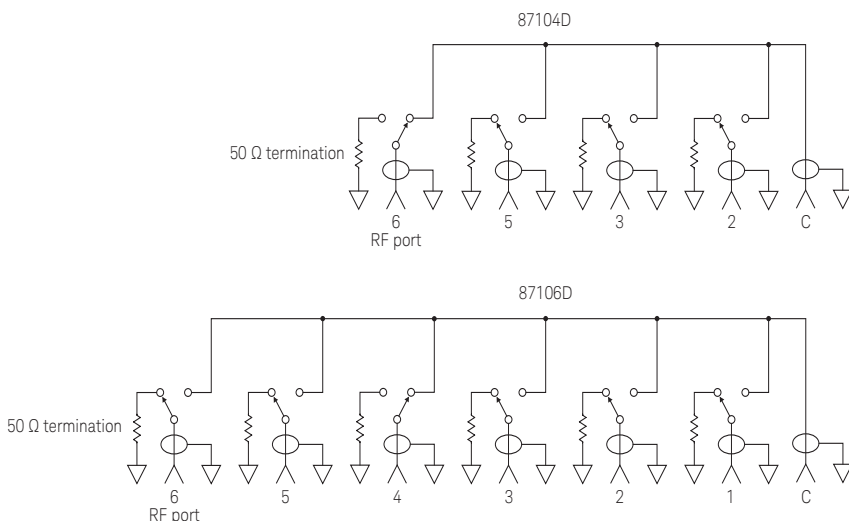

Figure 2. Keysight 87104D and 87106D simplified schematics

## Applications

Multiport switches find use in a large number of applications, increasing system flexibility and simplifying system design.

### Simple signal routing

The simplest signal routing scheme takes the form of single input to multiple outputs. These matrixes are often used on the front of an analyzer in order to test several two-port devices sequentially or for testing multiport devices. In surveillance applications, a multiport switch can be used for selecting the optimum antenna in order to intercept a signal. Two methods can be used to accomplish the single input to multiple output arrangement. Traditionally where isolation greater than 60 dB was required, a tree matrix composed of SPDT switches was used. While this gave great isolation, it was at the cost of more switches (Figure 3). The 87104/6D switches have port-to-port isolations typically greater than 65 dB at 40 GHz, eliminating the need to use a tree matrix in order to achieve high isolation (Figure 4). In addition to the reduced part count, the path lengths are shorter, so insertion loss is less, and paths are of equal length, so phase shift is constant.

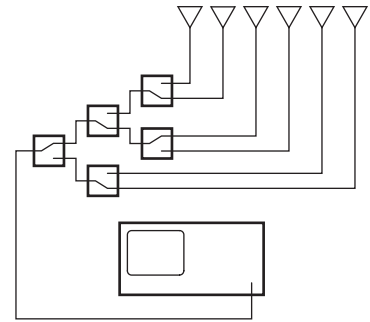

Figure 3. Tree matrix

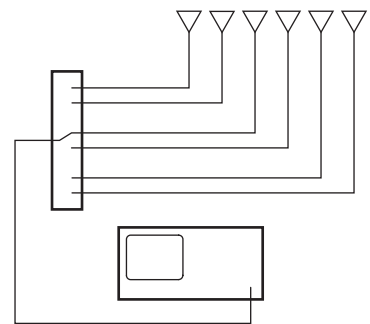

Figure 4. Multiport matrix

### Full access switching

Full access switching systems give the flexibility to route multiple input signals to multiple outputs simultaneously. Full access switching matrixes find use in generic test systems; they provide flexible routing of signals to and from many different devices under test and stimulus and analysis instrumentation. Cross-point matrixes, using single-pole double-throw (SPDT) and cross-point switches, have traditionally been used in order to maintain high channel-to-channel isolation (Figure 5). As with the tree matrixes, it is at the cost of more hardware and performance. Full access switching can also be achieved using multiport switches (Figure 6).

The advantage of the multiport matrix over the cross-point matrix is lower insertion loss and improved SWR performance due to consistent path length and fewer switches and connecting cables.

### Dedicated switching

There are a number of applications where switching is used, not for flexibility, but to accomplish a particular function within an instrument. For example, switched filter banks for reducing harmonics in the output of sources or to the input of analyzers can use multiport switches in series to select the right filter for the band of interest. For larger switching systems, where many switches will be used to provide complex signal routing, a switch driver such as the Keysight 11713B/C with 87104/6 switches is recommended.

### Driving the switch

Each RF path can be closed by applying ground (TTL “High” for Option T24) to the corresponding “drive” pin. In general, all other RF paths are simultaneously opened by internal logic.

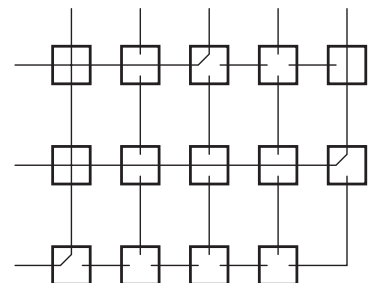

Figure 5. Cross-point matrix

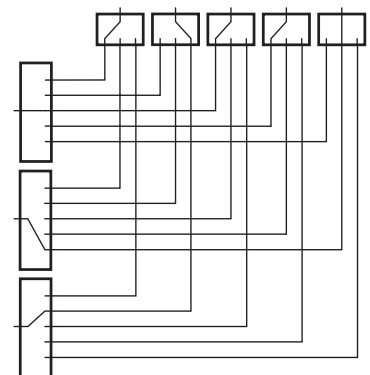

Figure 6. Full access matrix

## Standard drive (Option 024)

See Figure 14 for drive connection diagrams.

- Connect pin 1 to supply (+20 VDC to +32 VDC)
- Connect pin 15 to ground (see Note 1).
- Select (close) desired RF path by applying ground to the corresponding “drive” pin; for example, ground pin 3 to close RF path 1 (see Note 2).
- To select another RF path, ensure that all unwanted RF path “drive” pins are disconnected from ground (to prevent multiple RF path engagement). Ground the “drive” pin which corresponds to the desired RF path (see Note 3).
- To open all RF paths, ensure that all RF path “drive” pins are disconnected from ground. Then, connect pin 16 to ground. Note: This feature is not available with Option 100.

## TTL drive (Option T24)

See Figure 14 for drive connection diagrams.

- Connect pin 1 to supply (+20 VDC to +32 VDC).
- Connect pin 15 to ground (see Notes 1, 4).
- Select (close) desired RF path by applying TTL “High” to the corresponding “drive” pin; for example apply TTL “High” to pin 3 to close RF path 1 (see Note 2).
- To select another path, ensure that all unwanted RF path “drive” pins are at TTL “Low” (to prevent multiple RF path engagement). Apply TTL “High” to the “drive” pin which corresponds to the desired RF path (see Note 3).
- To open all RF paths, ensure that all RF path “drive” pins are at TTL “Low.” Then, apply TTL “High” to pin 16. Note: This feature is not available with Option 100.

## Electronic position indicators (87104/6D)

The electronic position indicators consist of optically isolated, solid-state relays which are driven by photo-electric sensors coupled to the mechanical position of the RF path’s moving elements (Figure 7). The circuitry consists of a common that can be connected to an output corresponding to each RF path. If multiple RF paths are engaged, the position indicator corresponding to each closed RF path will be connected to the common. The solid state relays are configured for AC and/or DC operation. (See indicator specifications.) The electronic position indicators require that the supply (20 to 32 VDC) be connected to pin 1 and ground connected to pin 15.

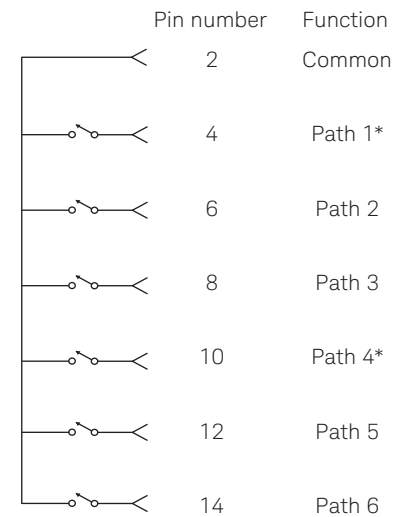

\* Paths 1 and 4 are not connected for the 87104D/E

Figure 7. Pin function diagram

### Notes:

1. Pin 15 must always be connected to ground to enable the electronic position-indicating circuitry and drive logic circuitry.  
**CAUTION: IF PIN 15 IS NOT CONNECTED TO POWER SUPPLY GROUND, CATASTROPHIC FAILURE WILL OCCUR.**
2. After the RF path is switched and latched, the drive current is interrupted by the electronic position-sensing circuitry. Pulsed control is not necessary, but if implemented, the pulse width must be 15 ms minimum to ensure that the switch is fully latched.
3. The default operation of the switch is break-before-make. Make-before-break switching can be accomplished by simultaneously selecting the old RF path “drive” pin and the new RF path “drive” pin. This will simultaneously close the old RF path and the new RF path. Once the new RF path is closed (15 ms), de-select the old RF path “drive” pin while leaving the new RF path “drive” pin selected. The switch circuitry will automatically open the old RF path while leaving the new RF path engaged.
4. In addition to the quiescent current supplying the electronic position-sensing circuitry, the drive current flows out of pin 15 (during switching) on TTL drive switches (Option T24).

## Specifications

Specifications describe the instrument’s warranted performance.

**Supplemental** and **typical characteristics** are intended to provide information useful in applying the instrument by giving typical, but not warranted performance parameters.

Maximum power rating	
Into internal termination	1 W CW 50 W peak, 10 μs max pulse width, not to exceed 1 W average
Into thru path	
Hot switching	2 W CW 100 W peak, 10 μs max pulse width, not to exceed 2 W average
Cold switching	See Figure 8

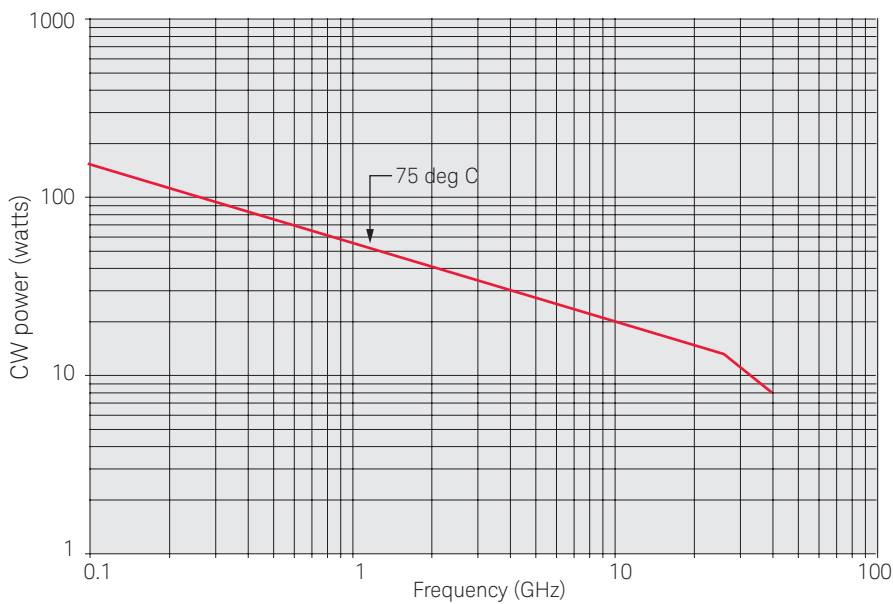

Figure 8. Maximum incident CW power (cold switching) vs. frequency

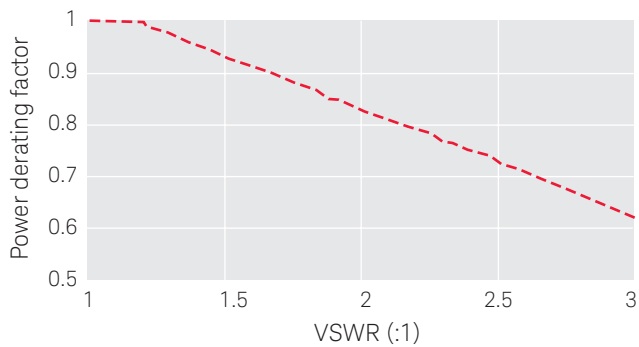

Figure 9. Power derating factor versus VSWR

### Reference conditions:

- Cold switching only (NO Hot switching)
- Ambient temperature of 75 °C or less
- Sea level (0.88 derating @ 15,000 ft.)
- Load VSWR < 1.2 (see graph for derating above 1.2 VSWR)

### Indicator specifications

- Maximum withstand voltage: 60 V
- Maximum current capacity: 150 mA
- Maximum “ON” resistance: 2.5 Ω
- Maximum “OFF” resistance: 10 G Ω

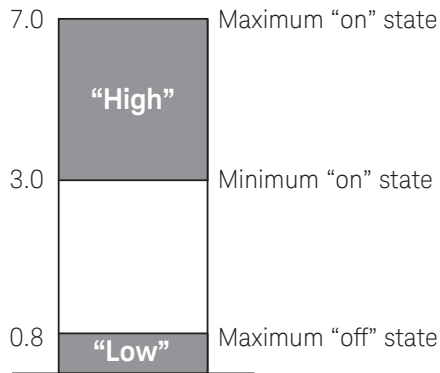

Figure 10. TTL control voltage states (Option T24)

### Switch drive specifications

Parameter test	Conditions	Min	Nom	Max	Units
<b>Supply voltage, <math>V_{cc}</math></b>					
Option 024 and T24		20	24	32	V
<b>Supply current, <math>I_{cc}</math></b>					
Switching pulse width $\geq 15$ ms: $V_{cc} = 24$ VDC <sup>1</sup>					
Option 024 and T24			200 <sup>1</sup>		mA
<b>Supply current (quiescent)</b>					
Option 024 and T24		25		50	mA
<b>Option T24</b>					
High level input		3		7	V
Low level input				0.8	V
Max high input current	$V_{cc} = \text{Max}$ $V_{input} = 3.85$ VDC		1	1.4	mA

1. Closing one RF path requires 200 mA. Add 200 mA for each additional RF path closed or opened. Using all RF paths open (selecting pin 16) requires 200 mA per RF path reset with  $V_{cc}=24$  VDC.

<b>87104/6D</b>	
Frequency range	DC to 40 GHz
Insertion loss (see Figure 11)	0.3 dB + 0.015 x frequency (GHz), DC to 26.5 GHz 0.030 x frequency (GHz) – 0.1 dB, 26.5 to 40 GHz
Isolation (see Figure 12)	100 dB minimum, DC to 12 GHz 80 dB minimum, 12 to 15 GHz 70 dB minimum, 15 to 20 GHz 65 dB minimum, 20 to 40 GHz
SWR	1.3 maximum, DC to 4 GHz 1.35 maximum, 4 to 12.4 GHz 1.5 maximum, 12.4 to 18 GHz 1.7 maximum, 18 to 26.5 GHz 1.95 maximum, 26.5 to 40 GHz
Repeatability (Up to 5 million cycles measured at 25 °C)	0.03 dB maximum
Connectors	2.92 (f)

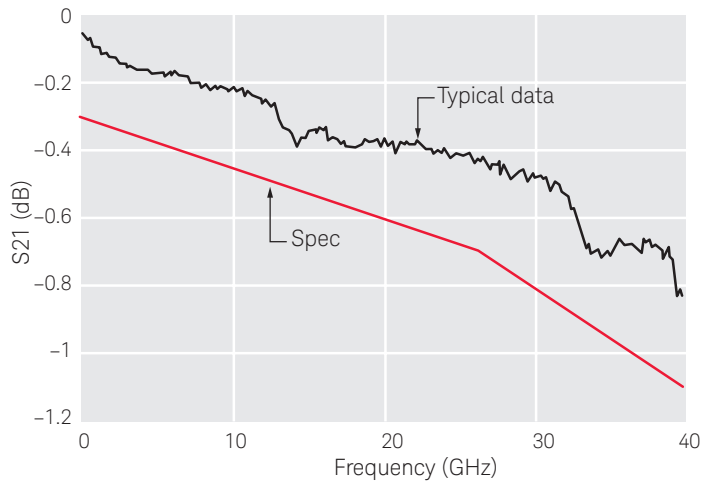

Figure 11. 87104/6D insertion loss versus frequency

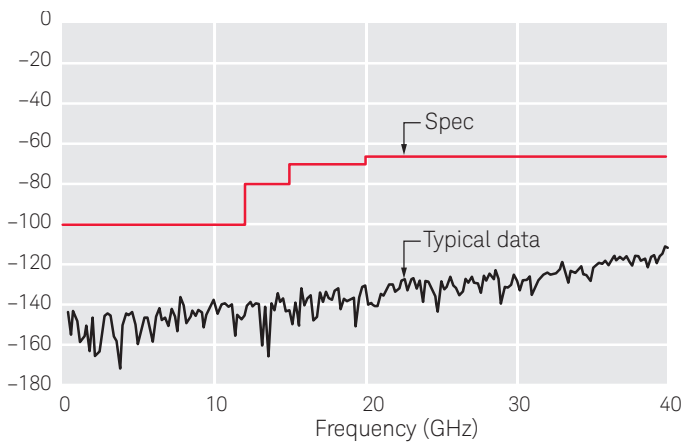

Figure 12. 87104/6D isolation loss versus frequency

## Supplemental characteristics

Environmental specifications	
Operating temperature	-25 to 75 °C
Storage temperature	-55 to 85 °C
Temperature cycling	-55 to 85 °C, 10 cycles per MIL-STD-202F, Method 107D, Condition A (modified)
Vibration operating	7 g: 5 to 2000 Hz at 0.25 in p-p Survival: 20 g: 20 to 2000 Hz at 0.06 in p-p, 4 min/cycle, 4 cycles/axis Random: 2.41 g (rms) 10 min/axis
Shock	Half-sine: 500 g at 0.5 ms, 3 drops/direction, 18 total
Operating	50 g at 6 ms, 6 directions
Moisture resistance	65 °C, 95% RH, 10 days per MIL-STD-202F, Method 106E
Altitude storage	50,000 feet (15,240 meters per MIL-STD-202F, Method 105C, Condition B)
RFI	Radiated emission per CISPR 11
Magnetic field	< 5 gauss 1/4 inch from surface



## Mechanical Dimensions

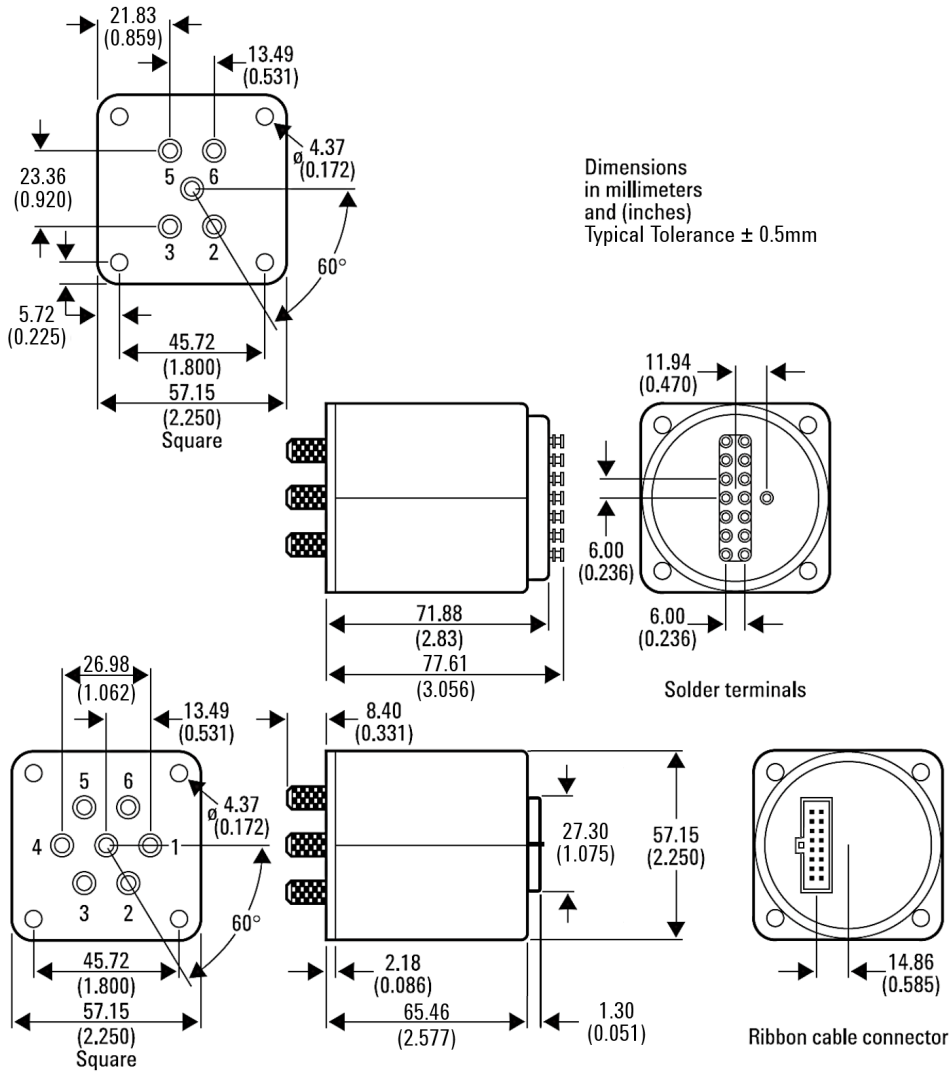

Parameter	Specification
Dimension	Figure 13
Net weight, kg (lb)	0.229 (0.5)

Figure 13. Mechanical dimensions

## Troubleshooting

Symptom	Possible cause
Will not switch	Not connected to supply
	Supply < 20 V
	Supply current too low
	Not connected to ground
	Select line not at ground (std)
	TTL “Low” voltage too high (Option T24)
	All-path-open line selected
Position indications do not work	Supply not connected
	Supply < 20 VDC
	Pin 15 not connected to ground

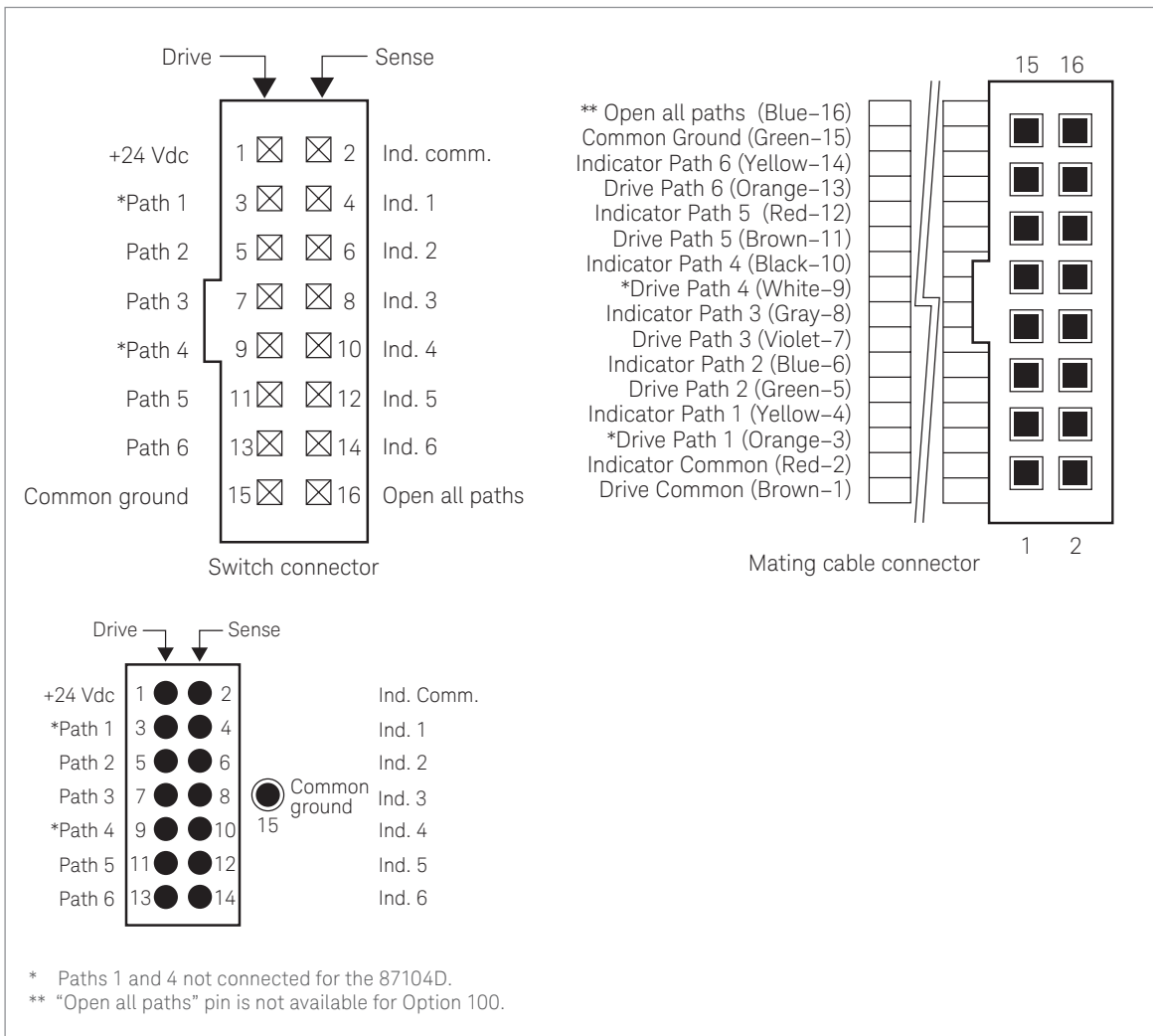

Figure 14. Drive connection diagrams with Option 100

## Ordering Information

Switches	
87104D	DC to 40 GHz, SP4T terminated
87106D	DC to 40 GHz, SP6T, terminated
Option 161	16-pin DIP socket and connector with 24-inch ribbon cable
Option 100	Solder terminals to replace ribbon cable
Option 024	24 V DC
Option T24	TTL/5 V CMOS compatible option

Note: Options 024 and 161 are default options for dc drive and connector.

Drivers	
11713B/C Attenuator switch driver	Drives up to 10 or more sections of switches or attenuators.
Option 201 Accessory cable	Viking connector to bare tinned wires (60 inches long). Use to connect 11713B/C to 87104/106 with Option 100. One required with 87104D Option 100; two required with 87106D Option 100.
Option 401 Accessory cable	Dual-viking connector to 16-pin DIP connector. Use to connect 11713B/C to 87106 default Option 161.
Option 601 Accessory cable	Viking connector to 16-pin DIP connector. Use to connect 11713B/C to 87104 default Option 161.

## Related literature

Publication title	Pub number
<i>Keysight Bench and System Switching Products Brochure</i>	5989-9872EN
<i>Keysight RF and Microwave Switch Selection Guide</i>	5989-6031EN
<i>Keysight 11713B/C Attenuator/Switch Drivers Configuration Guide</i>	5989-7277EN
<i>Power Handling Capability of Electromechanical Switches Application Note</i>	5989-6032EN
<i>Coaxial Electromechanical Switches: How Operating Life and Repeatability of Keysight's Electromechanical Switches Minimize System Uncertainty Application Note</i>	5989-6085EN

**myKeysight**

**myKeysight**

[www.keysight.com/find/mykeysight](http://www.keysight.com/find/mykeysight)

A personalized view into the information most relevant to you.

[www.keysight.com/go/quality](http://www.keysight.com/go/quality)

Keysight Technologies, Inc.

DEKRA Certified ISO 9001:2008

Quality Management System

**Keysight Channel Partners**

[www.keysight.com/find/channelpartners](http://www.keysight.com/find/channelpartners)

Get the best of both worlds: Keysight's measurement expertise and product breadth, combined with channel partner convenience.

[www.keysight.com/find/mta](http://www.keysight.com/find/mta)



For more information on Keysight Technologies' products, applications or services, please contact your local Keysight office. The complete list is available at: [www.keysight.com/find/contactus](http://www.keysight.com/find/contactus)

**Americas**

Canada	(877) 894 4414
Brazil	55 11 3351 7010
Mexico	001 800 254 2440
United States	(800) 829 4444

**Asia Pacific**

Australia	1 800 629 485
China	800 810 0189
Hong Kong	800 938 693
India	0124 229 2010
Japan	0120 (421) 345
Korea	080 769 0800
Malaysia	1 800 888 848
Singapore	1 800 375 8100
Taiwan	0800 047 866
Other AP Countries	(65) 6375 8100

**Europe & Middle East**

Austria	0800 001122
Belgium	0800 58580
Finland	0800 523252
France	0805 980333
Germany	0800 6270999
Ireland	1800 832700
Israel	1 809 343051
Italy	800 599100
Luxembourg	+32 800 58580
Netherlands	0800 0233200
Russia	8800 5009286
Spain	800 000154
Sweden	0200 882255
Switzerland	0800 805353
	Opt. 1 (DE)
	Opt. 2 (FR)
	Opt. 3 (IT)
United Kingdom	0800 0260637

For other unlisted countries:  
[www.keysight.com/find/contactus](http://www.keysight.com/find/contactus)  
 (BP-02-06-15)

