

8

Detectors

| | |
|-------------------------------------|----|
| Planar-Doped Barrier Diode Detector | 67 |
| Low-Barrier Schottky Diode Detector | 70 |
| Broadband Directional Detector | 73 |



DETECTORS

Overview

Applications

Keysight Technologies broadband detectors¹ span frequencies from 100 kHz to 50 GHz. These detectors are widely used on the design and production test bench, as well as for internal components of test system signal interface units. They find use in a variety of test and measurement applications.

- Power monitoring
- Source leveling
- Video detection
- Swept transmission and reflection measurements

Technology

Keysight detectors are available in two families – Silicon Low Barrier Schottky Diode (LBSD) and Gallium Arsenide Planar Doped Barrier Diode (GaAs PDBD) detectors. The Gallium Arsenide detector technology produces diodes with extremely flat frequency response to 50 GHz. Also, the GaAs PDBD detector has a wider operating temperature range (–65 °C to +100 °C), and is less sensitive to temperature changes.

Key Specifications

- Frequency range
- Frequency response
- Open circuit voltage sensitivity
- Tangential sensitivity
- Output voltage versus temperature
- Rise time
- SWR
- Square-law response
- Input power

Frequency Range

Frequency range can be one of the most important factors to consider when specifying detectors. In the past, broadband frequency coverage was equated with high performance. It is important to note that though broadband coverage may be desirable in multi-octave applications, a good octave range detector may be your best solution for non-swept applications. Broadband coverage saves you from the inconvenience of having to switch between detectors when making measurements, but you may be sacrificing SWR and frequency response flatness.

Frequency Response

Frequency response is the variation in output voltage versus frequency, with a constant input power. Frequency response is referenced to the lowest frequency of the band specified. Keysight typically uses –30 dBm to measure frequency response. Keysight uses precision thin-film input circuitry to provide good, broadband input matching. Exceptionally flat frequency response is provided by the very low internal capacitance of the PDB diode. Also, excellent control of the video resistance of the PDB diode is obtained by the precision growth of molecular beam epitaxy (MBE) layers during diode fabrication.

Figure 1 displays frequency response characteristics comparing Keysight LBSD and PDBD detectors. The figure indicates typical performance of each device and the published specifications. Frequency response specifications include the mismatch effects of the detector input SWR specifications. Note that the Keysight 8474E, representative of PDBD detectors, is exceptionally flat beyond 26.5 GHz.

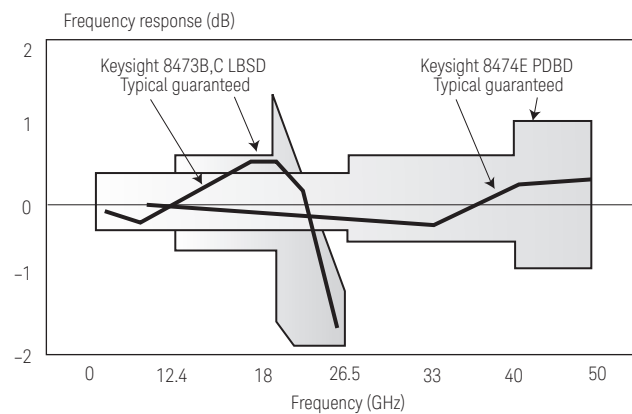

Figure 1. Detector frequency response characteristics

Open Circuit Voltage Sensitivity

The open circuit voltage sensitivity (K) describes the slope of the transfer function of the detectors. This represents the conversion of RF/microwave power to a voltage at the output connector, typically specified in mV/μW. The value is an indication of the efficiency of the diode in converting the input power to a useful voltage.

Sensitivity is measured with the detector terminated in a high impedance. When used in video pulse applications, the sensitivity will appear to be much lower when terminated in 50 or 75 Ω for connection to an oscilloscope. Another factor, called the Figure of Merit, gives an indication of low-level sensitivity without consideration of a load circuit. It is useful for comparing detectors with different values of K and R_v. Figure of Merit equals $K/\sqrt{R_v}$, where R_v = internal video resistance.

¹ See Waveguide chapter for additional products.

Tangential Sensitivity

Tangential sensitivity is the lowest input signal power level for which the detector will have an 8 dB signal-to-noise ratio at the output of a test video amplifier. Test amplifier gain is not relevant because it applies to both signal and noise. Keysight detectors are designed for optimal flatness and SWR. Figure 2 shows typical tangential sensitivity.

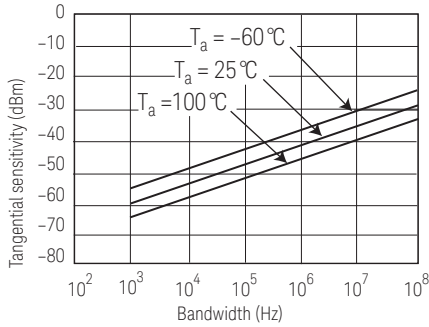

$$P_{TSS} \text{ (watts)} = \frac{3.23 \times 10^{-10} \sqrt{BFR_V}}{K} @ 300^\circ\text{K}$$

Where: B = Video amplifier bandwidth (Hz) R_V = Video resistance (Ω)
 F = Video amplifier noise factor K = Open circuit voltage Sensitivity (mV/uW)
 = 10 (Noise figure/10)

Figure 2. Typical tangential sensitivity performance

Output Voltage Versus Temperature

For applications such as power monitoring and leveling that require stable output voltage versus input power, the designer can choose a resistive termination that will optimize the transfer function over a wide temperature range. Figure 3 shows how sensitivity changes over temperature with different load resistances. In this case, a value between 1 k Ω and 10 k Ω will be optimum for 0 to 50 $^\circ\text{C}$.

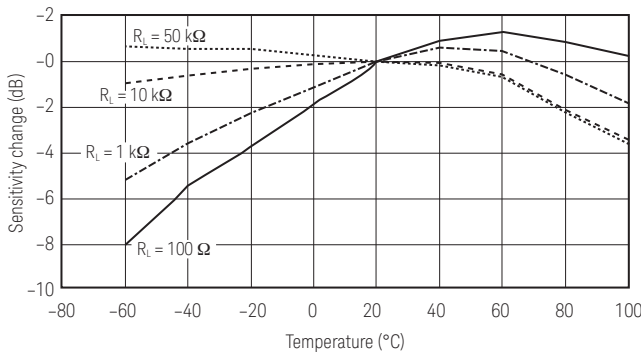

Figure 3: Typical output response with temperature (Pin <-20 dBm) (Planar-Doped Barrier Diode)

Rise Time

In applications where the frequency response of another microwave device is being measured, or where a fast rise time response is required for accurate measurements, the rise time of the detector becomes very important. It is critical to note that the rise time is dependent upon the characteristics of the detector AND the test equipment.

Figure 4 shows the typical equivalent circuit of a test detector, and can help in devising the external terminations and cables to connect to an oscilloscope or other instrument. The following equation gives the approximate rise time for different conditions of load resistance and capacitance. Note that rise time can be improved (lowered) with a termination of less than 50 Ω . This rise time improvement comes at the expense of lower pulse output voltage. The lower voltage can be overcome with the gain of a high performance oscilloscope.

$$T_r \text{ (10% to 90%)} = \frac{2.2 \cdot R_L \cdot R_V \cdot (C_L + R_V)}{R_L + R_V} = \frac{0.35}{BW}$$

Where

R_L = Load impedance C_L = Load capacitance
 R_V = Video impedance C_b = Bypass capacitance

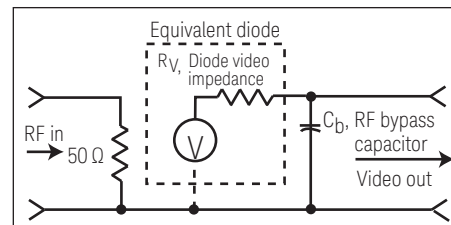

Typical values:
 R_V (diode video impedance) = 1.5 k Ω ¹
 C_b (RF bypass capacitor) = 27 pF nom.

¹ @ 25 $^\circ\text{C}$ and P_{in} < -20 dBm.
 Extremely sensitive to power and temperature

Figure 4. Detector model

DETECTORS

Broadband Match (SWR)

In many applications, the match (SWR) of the detector is of prime importance in minimizing the uncertainty of power measurements. If the input of the detector is not well matched to the source, simple and multiple mismatch errors will result, reducing the accuracy of the measurement.

Figure 5 represents the mismatch error introduced by multiple reflections caused by a mismatch between the detector and the source. For a detector SWR of 2.0 and source SWR of 2.0, the uncertainty is ± 1.0 dB. For the LBSD and PDBD models, the integration of the diode with the 50 Ω matching resistor results in an excellent broadband match. Both LBSD and PDBD detectors utilize thin-film technology which yields a precision matching circuit that minimizes stray reactance and yields very good performance. Figure 6 displays typical SWR for the Keysight 8473B,C LBSD detector and the Keysight 8473D PDBD detector.

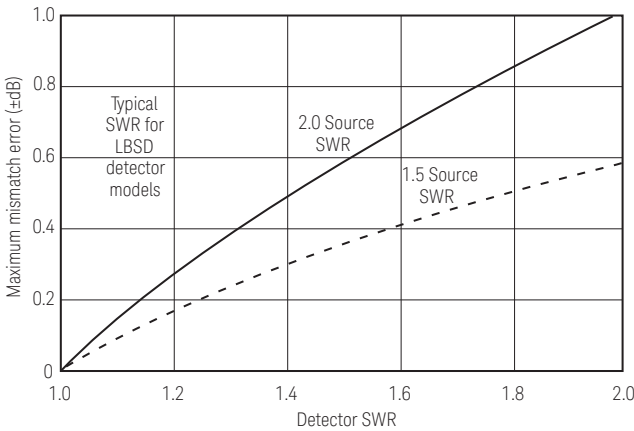

Figure 5. Measurement uncertainty due to detector source mismatch

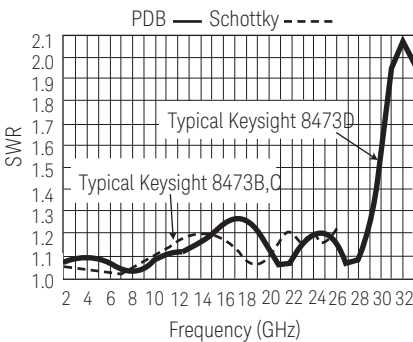

Figure 6. Typical SWR of detectors

Square Law Performance

When detectors are used in reflectometer and insertion loss setups, the measurement uncertainty depends on the output voltage being proportional to input power. The term square law comes from the output voltage being proportional to the input power (input voltage squared). Most microwave detectors are inherently square law from the P_{TSS} level up to about -15 dBm. Figure 7 shows this characteristic.

Figure 8 shows detector output in dB relative to $P_{in} = -20$ dBm. As P_{in} exceeds -20 dBm, the detector response deviates from square law. The user can select a load resistor that will extend the upper limit of the square law range beyond ± 15 dBm. By choosing the square law load option, the deviation from ideal square law response will be ± 0.5 dB (although the sensitivity specification is decreased by a factor of 4).

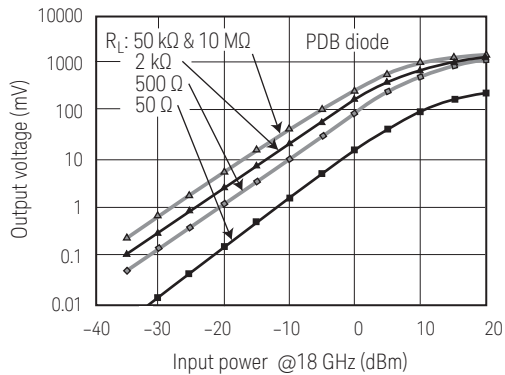

Figure 7. Typical detector square law response (mV)

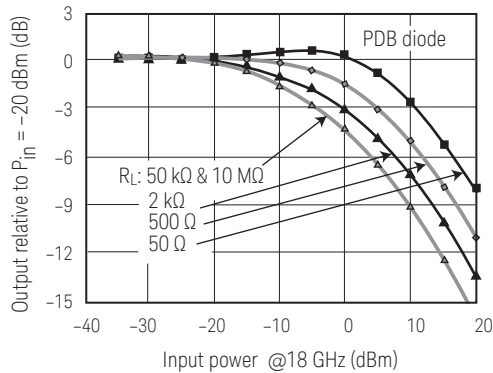

Figure 8. Typical detector square law response (dB)

Planar-Doped Barrier Diode Detector – DETECTORS



8471D planar-doped barrier detector



8471E planar-doped barrier detector



8473D planar-doped barrier detector



8474 family of planar-doped barrier detector

Planar-Doped Barrier Detectors

Keysight 8471D and 8471E detectors are planar-doped barrier detectors offering excellent performance to 2 and 12 GHz. The 8471D covers 100 kHz to 2 GHz with a BNC (m) input connector and the 8471E covers 10 MHz to 12 GHz with a SMA (m) input connector. Both detectors come standard with negative polarity output, a positive polarity output is available with option 103.

High Performance Planar-Doped Barrier Detectors

8474B/C/E detectors are the newest additions to the Keysight family of high performance detectors. Utilizing a gallium arsenide, planar-doped barrier detecting diode, these detectors offer superior

performance when compared to Schottky diodes. They feature extremely flat frequency response (typically better than ± 1 dB to 50 GHz) and very stable frequency response versus temperature.

These detectors are available with type-N, 3.5-mm, or 2.4-mm connectors. They are also offered with an option for positive output polarity (Option 103). Additionally, some detectors have an optimal square law load available (Option 102).

For applications requiring an octave band or less, 8474B/C/E detectors are available with frequency band options that feature lower SWR and flatter frequency response.

Specifications

| Model | 8471D | 8471E | 8473D | 8474B | 8474C | 8474E |
|--|--|---|--|----------------------|---|---|
| Frequency range (GHz) | 0.0001 to 2 | 0.01 to 12 | 0.01 to 33 | 0.01 to 18 | 0.01 to 33 | 0.01 to 50 |
| Frequency response (dB) | ± 0.2 to 1 GHz ± 0.4 to 2 GHz | ± 0.23 to 4 GHz ± 0.6 to 8 GHz ± 0.85 to 12 GHz | ± 0.25 to 14 GHz ± 0.4 to 26.5 GHz ± 1.25 to 33 GHz (± 2.0 dB typical to 40 GHz) | ± 0.35 to 18 GHz | ± 0.45 to 26.5 GHz ± 0.7 to 33 GHz | ± 0.4 to 26.5 GHz ± 0.6 to 40 GHz ± 1.0 to 50 GHz |
| Maximum SWR | 1.23 to 1 GHz 1.46 to 2 GHz | 1.2 to 4 GHz 1.7 to 8 GHz 2.4 to 12 GHz | 1.2 to 14 GHz 1.4 to 26.5 GHz 3.0 to 33 GHz (3.0 typical to 40 GHz) | 1.3 to 18 GHz | 1.4 to 26.5 GHz 2.2 to 33 GHz | 1.2 to 26.5 GHz 1.6 to 40 GHz 2.8 to 50 GHz |
| Low-level sensitivity (mV/ μ W) | > 0.5 | > 0.4 | > 0.4 | > 0.4 | > 0.4 > 0.34 to 50 GHz | > 0.4 to 40 GHz |
| Maximum operating input power | 100 mW | 200 mW | 200 mW | 200 mW | 200 mW | 200 mW |
| Typical short term maximum input power (<1 minute) | 0.7 W | 0.75 W | 1 W | 0.75 W | 0.75 W | 0.75 W |
| Video impedance (nom) | 1.5 k Ω | 1.5 k Ω | 1.5 k Ω | 1.5 k Ω | 1.5 k Ω | 1.5 k Ω |
| RF bypass capacitance (nom) | 6800 pF | 30 pF | 30 pF | 27 pF | 27 pF | 27 pF |
| Output polarity | Negative | Negative | Negative | Negative | Negative | Negative |
| Input connector | BNC (m) | SMA (m) | 3.5 mm (m) | Type-N (m) | 3.5 mm (m) | 2.4 mm (m) |
| Output connector | BNC (f) | SMC (m) | BNC (f) | BNC (f) | SMC (m) | SMC (m) |

DETECTORS – Planar-Doped Barrier Diode Detector (continued)

Options

| Model | 8471D | 8471E | 8473D | 8474B | 8474C | 8474E |
|--------------------------------------|------------|-------------------------------|------------|---------------------------------|------------|-------|
| Optimal square law load ¹ | Option 102 | N/A | N/A | Option 102 | N/A | N/A |
| Positive polarity output | Option 103 | Option 103 | Option 003 | Option 103 | Option 103 | N/A |
| Frequency band | N/A | Option 004 4 GHz operation | N/A | See PDBD frequency band options | | |

¹ Defined as ± 0.5 dB from ideal square law response

PDBD Frequency Band Options

| 8474B options | 001 | 002 | 004 | 008 |
|-------------------------|------------|------------|------------|------------|
| Frequency range (GHz) | 0.01 to 18 | 0.01 to 2 | 2 to 4 | 4 to 8 |
| Frequency response (dB) | ± 0.35 | ± 0.25 | ± 0.25 | ± 0.25 |
| Maximum SWR | 1.31 | 1.09 | 1.1 | 1.2 |

| 8474C options | 001 | 008 | 012 | 033 |
|-------------------------|------------|-----------|------------|------------|
| Frequency range (GHz) | 0.01 to 33 | 4 to 8 | 8 to 12.4 | 26.5 to 33 |
| Frequency response (dB) | ± 0.3 | ± 0.2 | ± 0.25 | ± 0.3 |
| Maximum SWR | 2.2 | 1.16 | 1.2 | 2.2 |

Environmental Specifications

| | |
|------------------------|---|
| Operating temperature: | -20 °C to +85 °C (Except Keysight 8474B: 0 °C to +75 °C) |
| Temperature cycling: | -55 °C to +85 °C; MIL-STD 883, Method 1010 (non-operating) |
| Vibration: | 0.6 inches D.A. 10 to 80 Hz; 20 g, 80 to 200 Hz; MIL-STD 883, Method 2007 |
| Shock: | 500 g, 0.5 ms; MIL-STD 883, Method 2002 |
| Acceleration: | 500 g; MIL-STD 883, Method 2001 |
| Altitude: | 50,000 ft (15,240 m); MIL-STD 883, Method 1001 |
| Salt atmosphere: | 48 hr, 5% solution; MIL-STD 883, Method 1009 |
| Moisture resistance: | 25 °C to 40 °C, 95% RH; MIL-STD 883, Method 1004 |
| RFI: | MIL-STD 461B |
| ESD: | 10 discharges at 25 kV to the body, not to the center conductor |

Outline Drawings

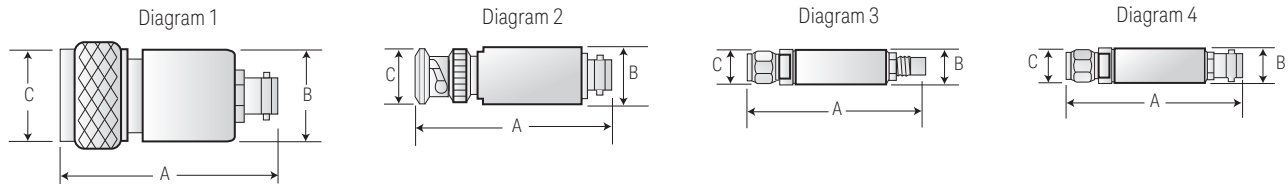

| Model | Length (Dim A) | Barrel diameter (Dim B) | Input connector diameter (Dim C) | Net weight | Shipping weight |
|--------------------|-----------------|-------------------------|----------------------------------|---------------|-----------------|
| Diagram 1 8474B | 60 mm (2.36 in) | 19 mm (0.74 in) | 21 mm (0.82 in) | 85 g (3 oz) | 454 g (16 oz) |
| Diagram 2 8471D | 63 mm (2.50 in) | 16 mm (0.62 in) | 14 mm (0.54 in) | 39 g (1.4 oz) | 454 g (16 oz) |
| Diagram 3 8471E | 39 mm (1.54 in) | 9.3 mm (0.36 in) | 7.9 mm (0.31 in) | 39 g (1.4 oz) | 454 g (16 oz) |
| 8474C | 41 mm (1.62 in) | 9.7 mm (0.38 in) | 7.9 mm (0.31 in) | 14 g (0.5 oz) | 454 g (16 oz) |
| 8474E | 41 mm (1.62 in) | 9.7 mm (0.38 in) | 7.9 mm (0.31 in) | 9 g (0.3 oz) | 454 g (16 oz) |
| Diagram 4 8473D | 48 mm (1.89 in) | 10 mm (0.39 in) | 7.9 mm (0.31 in) | 57 g (2 oz) | 454 g (16 oz) |

Ordering Information

8471D

8471D-102 square law load

8471D-103 positive polarity

8471E

8471E-004 0.01 to 4 GHz octave only

8471E-103 positive polarity

8473D

8473D-003 positive polarity

8474B

8474B-002 0.01 to 2 GHz octave only

8474B-004 2 to 4 GHz octave only

8474B-008 4 to 8 GHz octave only

8474B-102¹ square law load

8474B-103 positive polarity

8474C

8474C-008 4 to 8 GHz octave only

8474C-012 8 to 12.4 GHz octave only

8474C-033 26.5 to 33 GHz octave only

8474C-103 positive polarity

¹ Option 102 external square law load extends the square law region of the detector with deviation of ± 0.5 dB from the ideal square law response.

Related Literature

8471D coaxial RF microwave detectors datasheet,

part number **5952-0644**

8471E coaxial RF microwave detectors datasheet,

part number **5952-0802**

8473D planar-Doped barrier detector datasheet,

part number **5954-8878**

8474B/C/E coaxial GaAs microwave detectors datasheet,

part number **5952-0801**

Web Link

www.keysight.com/find/mta

DETECTORS – Low-Barrier Schottky Diode Detector



33330B LBSD detector



33330C LBSD detector



423B LBSD detector



8470B LBSD detector



8472B LBSD detector



8473B LBSD detector



8473C LBSD detector

Low-Barrier Schottky Diode (LBSD) Detectors

Keysight 423B, 8470B, 8472B, 8473B/C, 33330B/C LBSD detectors have been widely used for many years in a variety of applications including leveling and power sensing. They offer good performance and ruggedness. Matched pairs (Option 001) offer very good detector tracking. A square law load option (Option 002) extends the square law region to at least 0.1 mW (-10 dBm).

Specifications

| Model | 423B | 8470B | 8472B | 8473B | 33330B | 8473C | 33330C |
|---|----------------------------------|--|---|------------------------------------|------------------------------------|---|--|
| Freq. range (GHz) | 0.01 to 12.4 | 0.01 to 18 | 0.01 to 18 | 0.01 to 18 | 0.01 to 18 | 0.01 to 26.5 | 0.01 to 26.5 |
| Freq. response (dB) (±0.2 dB over any octave from 0.01 to 8 GHz on all models) | ±0.3 to 12.4 GHz | ±0.3 to 12.4 GHz ±0.5 to 15 GHz ±0.6 to 18 GHz | ±0.3 to 12.4 GHz ±0.5 to 15 GHz ±0.6 to 18 GHz | ±0.3 to 12.4 GHz ±0.6 to 18 GHz | ±0.3 to 12.4 GHz ±0.6 to 18 GHz | ±0.3 to 12.4 GHz ±0.6 to 20 GHz ±1.5 to 26.5 GHz ¹ | ±0.3 to 12.4 GHz ±0.6 to 20 GHz ±1.5 to 26.5 GHz |
| Maximum SWR (measured at –20 dBm) | 1.15 to 4 GHz 1.3 to 12.4 GHz | 1.15 to 4 GHz 1.3 to 15 GHz 1.7 to 18 GHz | 1.2 to 4.5 GHz 1.35 to 7 GHz 1.5 to 12.4 GHz 1.7 to 18 GHz | 1.2 to 4 GHz 1.5 to 18 GHz | 1.2 to 4 GHz 1.5 to 18 GHz | 1.2 to 4 GHz 1.5 to 18 GHz 2.2 to 26.5 GHz | 1.2 to 4 GHz 1.5 to 18 GHz 2.2 to 26.5 GHz |
| Low-level sensitivity (mV/μW) | > 0.5 | > 0.5 | > 0.5 | > 0.5 | > 0.5 | > 0.5 to 18 GHz > 0.18 to 26.5 GHz | > 0.5 to 18 GHz > 0.18 to 26.5 GHz |
| Maximum operating input power | 200 mW | 200 mW | 200 mW | 200 mW | 200 mW | 200 mW | 200 mW |
| Typical short term maximum input power (< 1 minute) | 1 W | 1 W | 1 W | 1 W | 1 W | 1 W | 1 W |
| Noise | < 50 μV | < 50 μV | < 50 μV | < 50 μV | < 50 μV | < 50 μV | < 50 μV |
| Video impedance (nom) | 1.3 kΩ | 1.3 kΩ | 1.3 kΩ | 1.3 kΩ | 1.3 kΩ | 1.3 kΩ | 1.3 kΩ |
| RF bypass capacitance (nom) | 50 pF | 50 pF | 50 pF | 30 pF | 30 pF | 30 pF | 30 pF |
| Output polarity | Negative | Negative | Negative | Negative | Negative | Negative | Negative |
| Input connector | Type-N (m) | APC-7 (m) | SMA (m) | 3.5 mm (m) | 3.5 mm (m) | 3.5 mm (m) | 3.5 mm (m) |
| Output connector | BNC (f) | BNC (f) | BNC (f) | BNC (f) | SMC (m) | BNC (f) | SMC (m) |

Options

| Model | 423B | 8470B | 8472B | 8473B | 33330B | 8473C | 33330C |
|---|---------------------|---|--|--|--|---|---|
| Matched response ² (Option 001) | ±0.2 dB to 12.4 GHz | ±0.2 dB to 12.4 GHz ±0.3 dB to 18 GHz | ±0.2 dB to 12.4 GHz ±0.3 dB to 18 GHz | ±0.2 dB to 12.4 GHz ±0.3 dB to 18 GHz | ±0.2 dB to 12.4 GHz ±0.3 dB to 18 GHz | ±0.2 dB to 12.4 GHz ±0.3 dB to 18 GHz ±0.5 dB to 26.5 GHz | ±0.2 dB to 12.4 GHz ±0.3 dB to 18 GHz ±0.5 dB to 26.5 GHz |
| Optimal square law load ³ | Option 002 | Option 002 | Option 002 | Option 002 | | Option 002 | |
| Positive polarity output | Option 003 | Option 003 | Option 003 | Option 003 | Option 003 | Option 003 | Option 003 |
| Connector | | Option 012 Type-N (m) input connector | Option 100 OSSM (f) output connector | | | | |

¹ From a –3.3 dB linear slope beginning at 20 GHz² Must order a quantity of 2 standard units and quantity of 2 Option 001 for a pair of detectors with matched frequency response³ Defined as ±0.5 dB from ideal square law response

Environmental Specifications

Operating temperature: –20 °C to +85 °C (except Keysight 423B: 0 °C to +55 °C)

Vibration: 20 g; 80 to 2000 Hz

Shock: 100 g, 11 ms

DETECTORS – Low-Barrier Schottky Diode Detector (continued)

Dimension Drawings

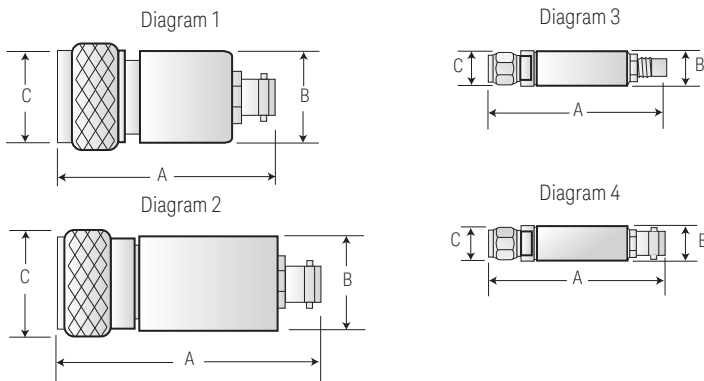

| Model | Length (Dim A) | Barrel diameter (Dim B) | Input connector diameter (Dim C) | Net weight | Shipping weight |
|---------------------|-----------------|-------------------------|----------------------------------|---------------|-----------------|
| Diagram 1 423B | 63 mm (2.47 in) | 20 mm (0.78 in) | 21 mm (0.82 in) | 114 g (4 oz) | 454 g (16 oz) |
| Diagram 2 8470B | 64 mm (2.50 in) | 19 mm (0.75 in) | 22 mm (0.87 in) | 114 g (4 oz) | 454 g (16 oz) |
| Diagram 3 33330B | 43 mm (1.70 in) | 9.7 mm (0.38 in) | 7.9 mm (0.31 in) | 14 g (0.5 oz) | 454 g (16 oz) |
| 33330C | 43 mm (1.70 in) | 9.7 mm (0.38 in) | 7.9 mm (0.31 in) | 14 g (0.5 oz) | 454 g (16 oz) |
| Diagram 4 8472B | 64 mm (2.50 in) | 14 mm (0.56 in) | 7.9 mm (0.31 in) | 57 g (2 oz) | 454 g (16 oz) |
| 8473B | 48 mm (1.89 in) | 10 mm (0.39 in) | 7.9 mm (0.31 in) | 14 g (0.5 oz) | 454 g (16 oz) |
| 8473C | 48 mm (1.89 in) | 10 mm (0.39 in) | 7.9 mm (0.31 in) | 14 g (0.5 oz) | 454 g (16 oz) |

Ordering Information

To add options to a product, use the following ordering scheme:

Model: 847xB/C (x= 0, 2 or 3)

Example options: 8472B-001, 8473C-001

423B-001 matched pair of detectors

847xB/C-001

33330B/C-001

423B-002 external square-law load

847xB/C-002

423B-003 positive polarity output

847xB/C-003

33330B/C-003

Related Literature

423B, 8470B, 8472B, 8473B/C Low barrier schottky diode detectors datasheet, part number **5952-8299**

33330B/C coaxial detectors datasheet, part number **5952-8164E**

Web Link

www.keysight.com/find/mta



83036C broadband directional detector

83036C Broadband Directional Detector

This broadband microwave power sampler operates in much the same way as a directional coupler and detector combination. Comprised of a resistive bridge and PDB diode, this broadband device offers excellent frequency, temperature, and square law response characteristics.

With a 10 MHz to 26.5 GHz frequency range, a single 83036C can be used in many applications where two directional couplers and detectors were once required.

The maximum SWR is 1.7 above 50 MHz on both the input and output ports. Directivity of 14 dB matches that of most miniature couplers currently available. The maximum insertion loss is 2.2 dB.

The 83036C has been used with great success as the sampling element for external leveling of broadband swept frequency sources. The detector's extended frequency range increases the usable band to 100 MHz to 26 GHz, giving the user full use of a broadband source with external leveling. Other uses include the internal leveling element for sources, and forward/reverse power monitoring.

Specifications

| Model | Frequency range (GHz) | Frequency response (dB) | Max. SWR input/output (50 Ω nom) | Maximum thru line loss (dB) | Low level sensitivity | Maximum input power ¹ (into 50 Ω Load) | Maximum input power ¹ (into Open) | Input/output connector |
|--------|-----------------------|-------------------------|----------------------------------|-----------------------------|-----------------------|---|--|------------------------|
| 83036C | 0.01 to 26.5 | ±1.0 | 1.7 | 2.2 | 18 μV/μW | 32 dBm | 21 dBm | 3.5 mm (f) |

¹ With 2:1 source match

83036C Drawing

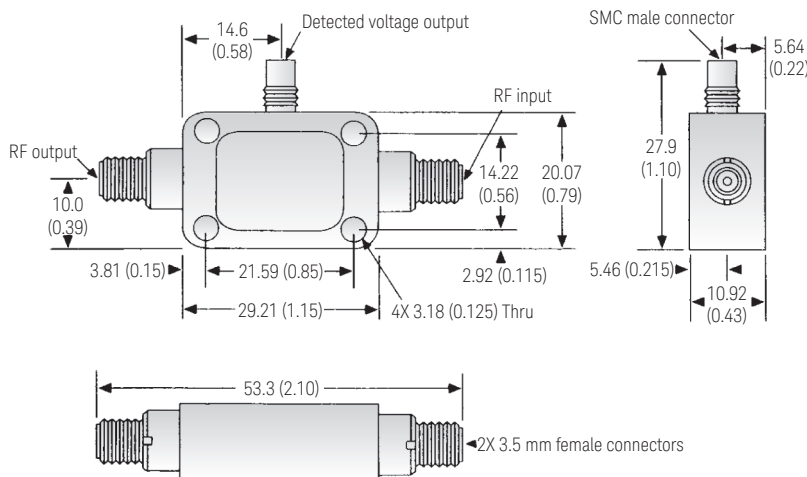

Dimensions are in mm (inches) nominal, unless otherwise specified.

Related Literature

83036C coaxial GaAs directional detector datasheet, part number **5952-1874**

Web Link

www.keysight.com/find/mta